

Product: **elko-san
San 30**

Type: **EVSAN30**
Datum: **15-1-2024**

Klantnaam:

Project:

Referentie:

Tekening

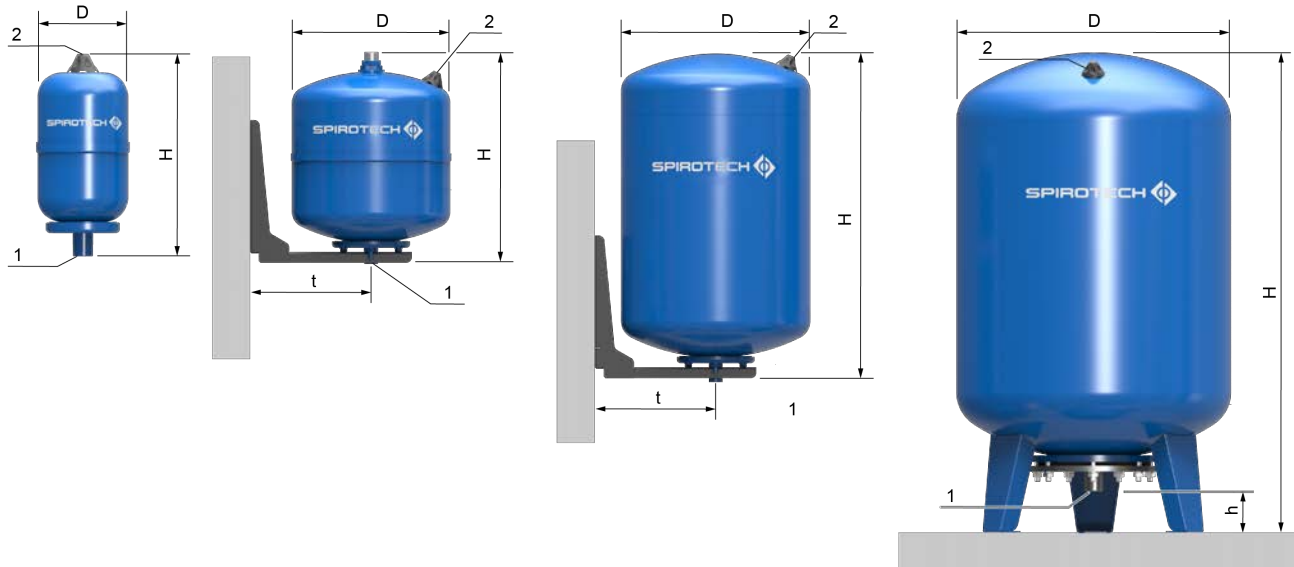

EVSAN 2

EVSAN 15 .. EVSAN 60

EVSAN 60

EVSAN 120 .. EVSAN 300

Ontwerp criteria

Tested in accordance with:	PED 2014/68/EU	
Max. safety temperature of the system without/with cooling vessel:	90/110	°C
Minimale temperatuur:	0	°C
Maximale temperatuur:	70	°C
Maximale systeemdruk:	10	bar-g
Permissible medium:	Water, Water/Glycol	
Kleur:	RAL 5015	

Afmetingen

D:	360 mm
H:	420 mm
h:	230 mm
t:	230 mm
Connection	R3/4
1	Expansion pipe
2	Gas pressure valve
Volume:	30 ltr
Ledig gewicht (circa):	9,6 kg

Wijzigingen voorbehouden