

Compact NSX400-630
FPower NSX / GV7
Compact NSJ
 Adapter for plug in base
 Adaptateur pour socle
 Adaptador zócalo

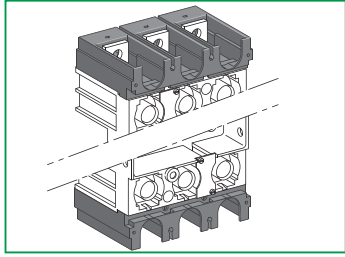

GHD16253AA-06

Schneider Electric Industries SAS
 35, rue Joseph Monier
 CS 30323
 F - 92506 Rueil Malmaison Cedex

www.schneider-electric.com



© 2011 Schneider Electric.
 All rights reserved.

IMPORTANT NOTE

- This device must be installed by a qualified electrician.
- We cannot accept any responsibility for failure to follow the instructions provided in this document.

REMARQUE IMPORTANTE

- L'installation de cet appareil doit être effectuée par des professionnels de l'électricité.
- Le non-respect des indications de la présente notice ne saurait engager la responsabilité du constructeur.

OBSERVACIÓN IMPORTANTE

- La instalación y mantenimiento de este aparato sólo debe ser realizado por electricistas profesionales.
- El fabricante no se hace responsable en caso de no cumplir con las indicaciones expuestas en este aviso.

重要注意事項

- 本装置必须由合格的电工进行安装。
- 我们不承担任何因未遵循本文档中的指南而导致的责任。

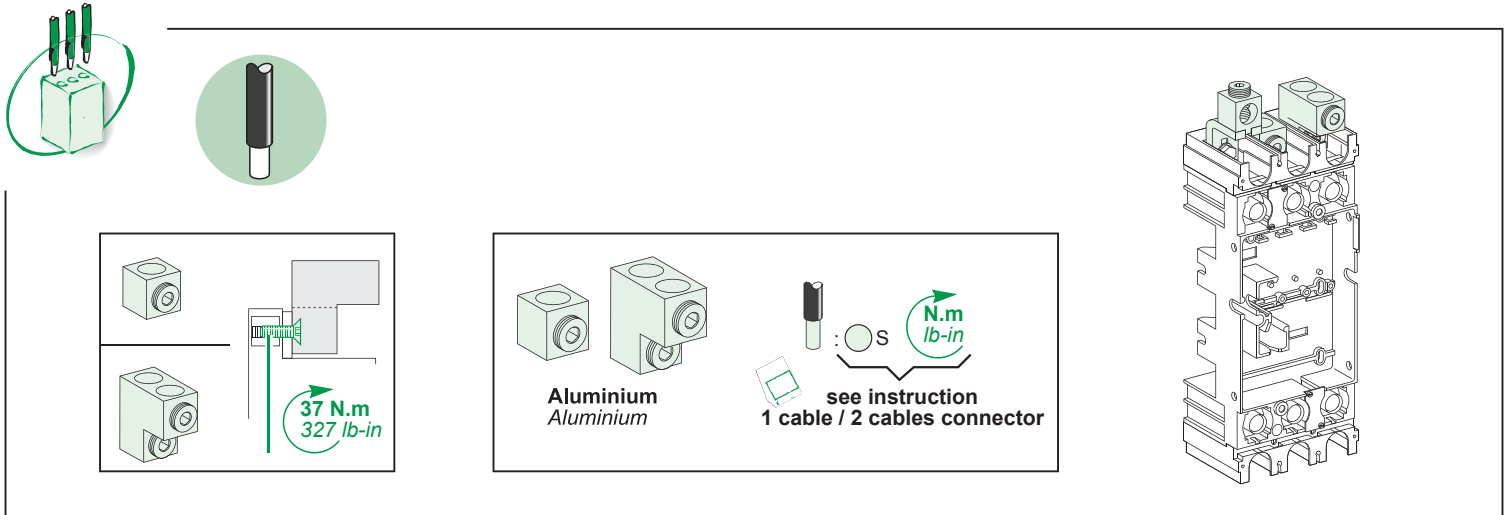
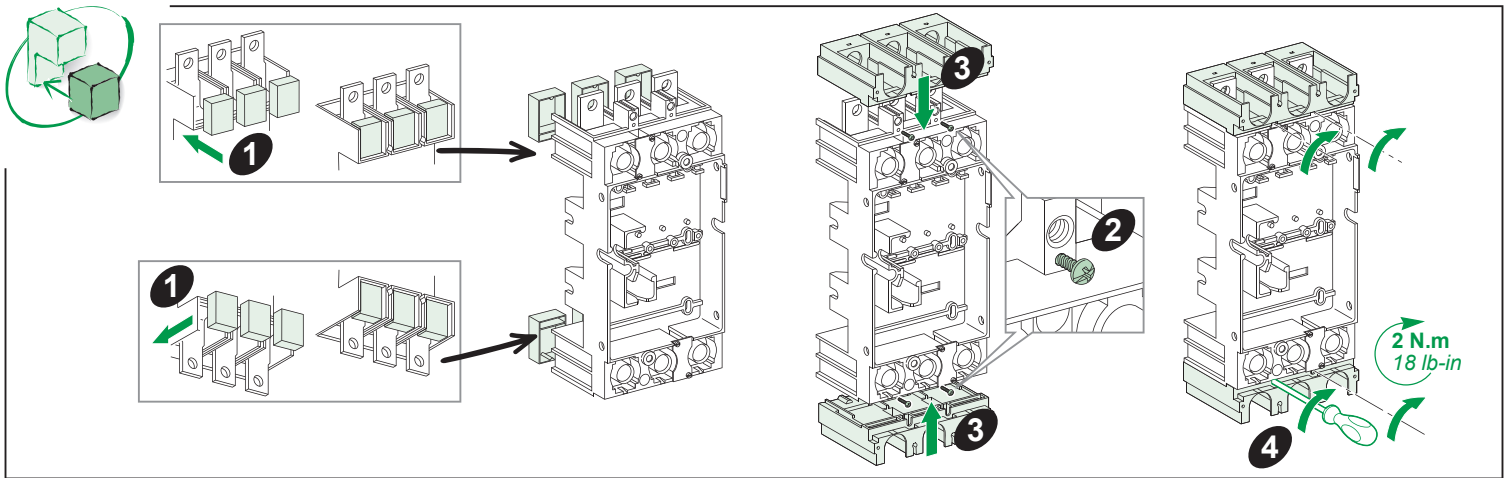
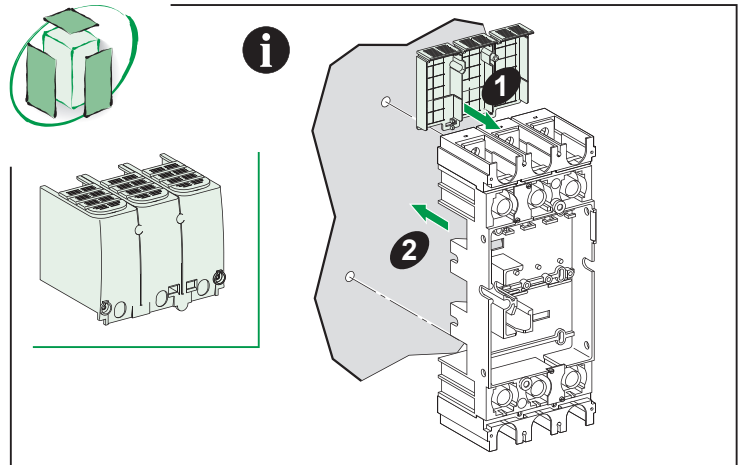
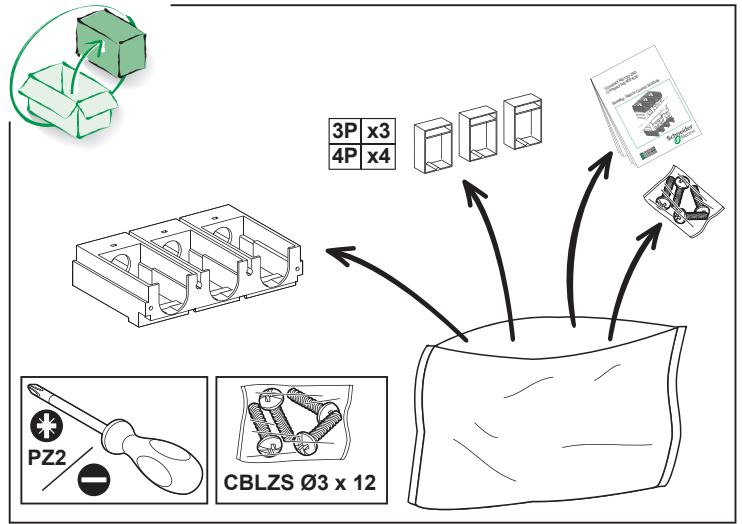

GHD16253AA-06

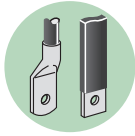
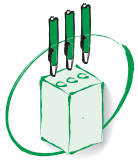

mm
in

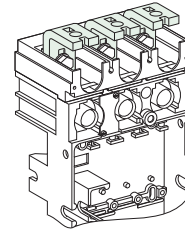
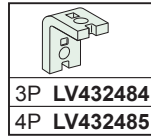
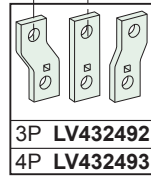
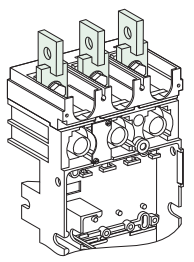
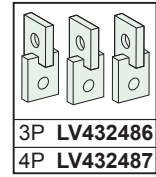
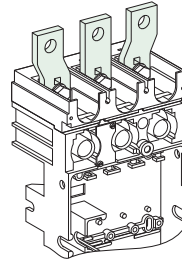
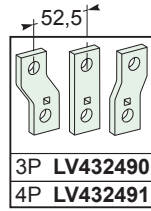
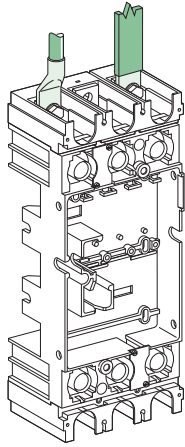
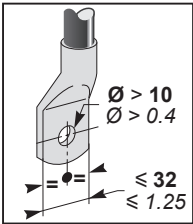
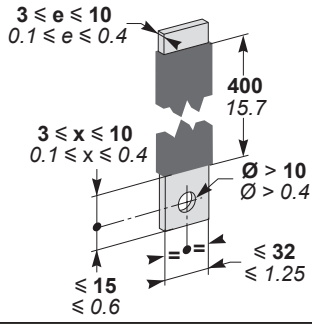

M10 x 27,5



50 N.m
442 lb-in

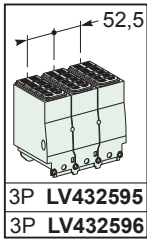
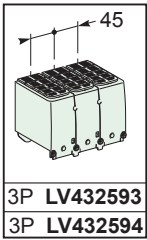
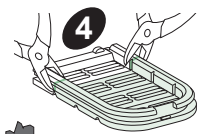
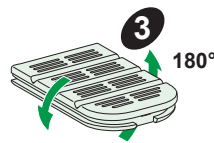
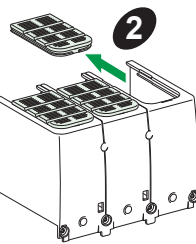
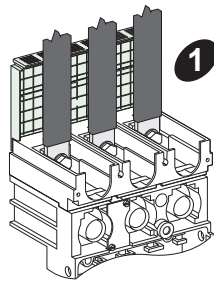

Mandatory U ≥ 500 V
Obligatoire U ≥ 500 V
Obligatorio U ≥ 500 V

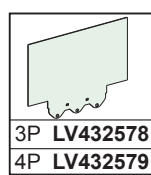
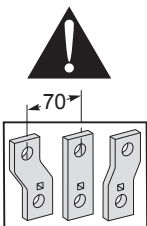
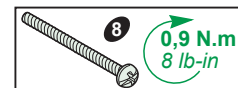
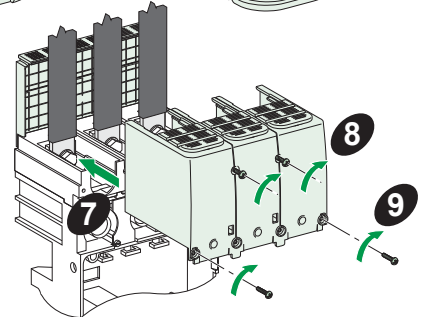
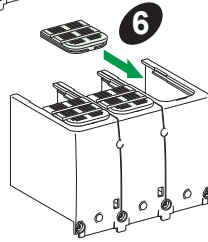
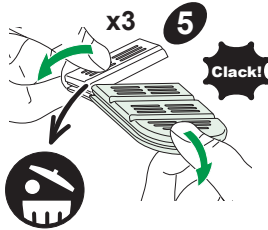

Mandatory U ≥ 500 V
Obligatoire U ≥ 500 V
Obligatorio U ≥ 500 V

