

Data Sheet | Item Number: 2000-5352

3-conductor sensor supply terminal block; Power supply from control panel side; with colored conductor entries; 2.5 mm²; Push-in CAGE CLAMP®; 2,50 mm²; orange

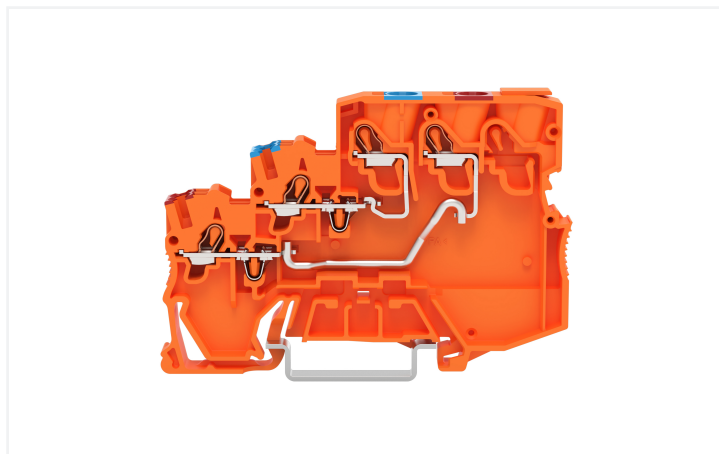

<https://www.wago.com/2000-5352>

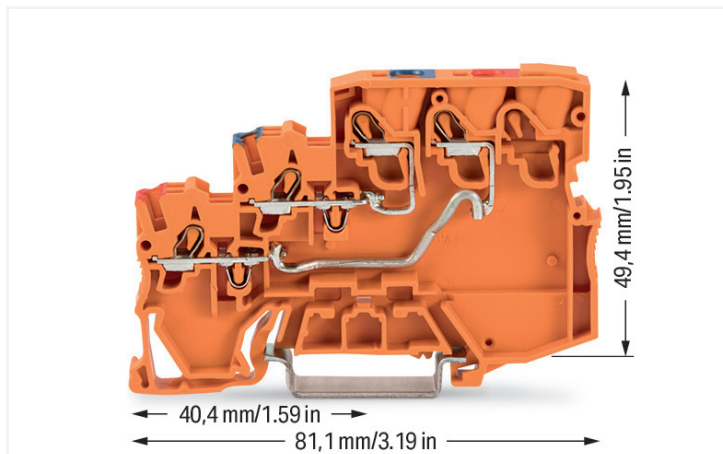

Color: ■ orange

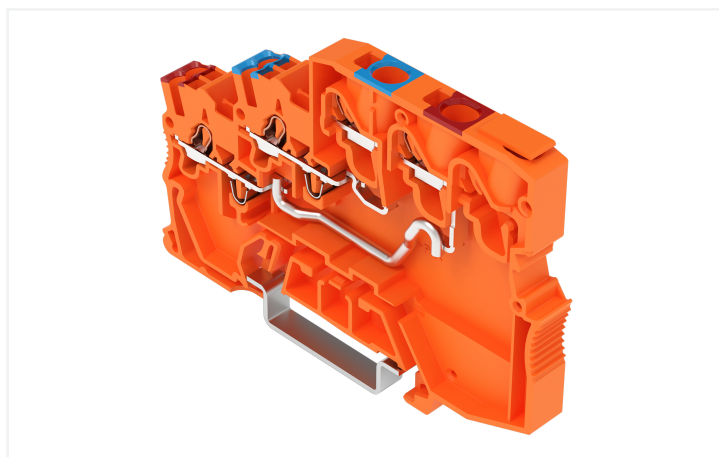
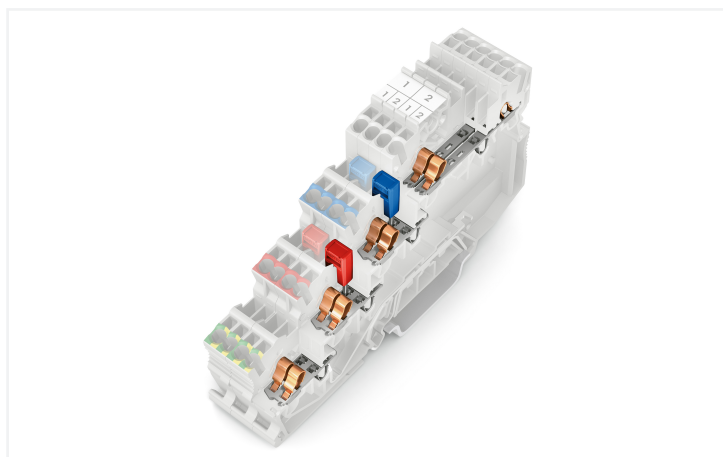

Similar to illustration

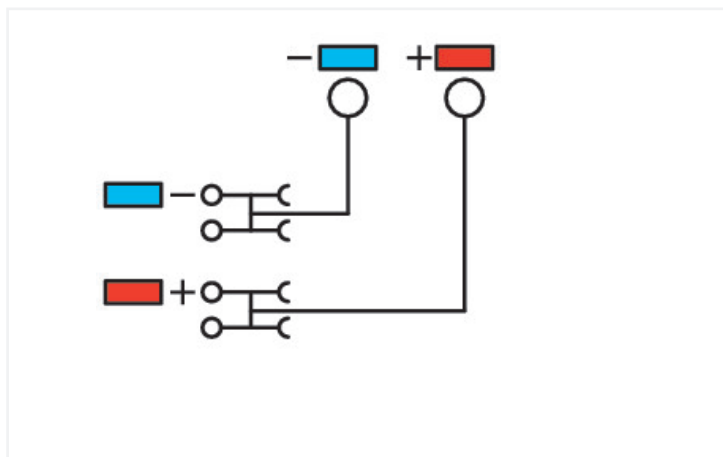

Sensor supply terminal block, 2000 Series, operating tool

Sensor supply terminal block (item number 2000-5352) is designed for seamless electrical installations. Ensure that the strip lengths are between 9 and 11 mm when connecting conductors to sensor supply terminal block. This product features conductor terminals and utilizes Push-in CAGE CLAMP®. Our Push-in CAGE CLAMP® is a universal, maintenance-free connection solution for all conductor types, offering a key advantage: both solid and fine-

stranded conductors with ferrules can be directly inserted without the need for tools or any preparation, such as crimping the ferrule. Depending on the conductor type, sensor supply terminal block is ideal for conductor cross sections ranging from 0.14 mm² to 1.5 mm² on one side and for conductor cross sections from 0.25 mm² to 4 mm² on the other side.

Electrical data

Ratings per	IEC/EN 60947-7-1		
Overvoltage category	III	III	II
Pollution degree	3	2	2
Nominal voltage	250 V	-	-
Rated impulse withstand voltage	4 kV	-	-
Rated current	28 A	-	-

Approvals per	UL 1059		
Use group	B	C	D
Rated voltage	300 V	-	300 V
Rated current	20 A	-	20 A

Approvals per	CSA 22.2 No 158		
Use group	B	C	D
Rated voltage	-	300 V	-
Rated current	-	20 A	-

Power Loss	
Power loss, per pole (potential)	1.0427 W
Rated current I_N for power loss specification	28 A
Resistance value for specified, current-dependent power loss	0.00133 Ω

General information

Wiring direction	Front-entry wiring
------------------	--------------------

Connection Data

Clamping units	8
Total number of potentials	2
Number of levels	3
Number of jumper slots	2

Connection 1	
Connection technology	Push-in CAGE CLAMP®
Actuation type	Operating tool
Connectable conductor materials	Copper
Nominal cross-section	1 mm ²
Solid conductor	0.14 ... 1.5 mm ² / 24 ... 16 AWG
Solid conductor; push-in termination	0.5 ... 1.5 mm ² / 20 ... 16 AWG
Fine-stranded conductor	0.14 ... 1.5 mm ² / 24 ... 16 AWG
Fine-stranded conductor; with insulated ferrule	0.14 ... 0.75 mm ² / 24 ... 18 AWG
Fine-stranded conductor; with ferrule; push-in termination	0.5 ... 0.75 mm ² / 20 ... 18 AWG
Note (conductor cross-section)	Depending on the conductor characteristic, a conductor with a smaller cross-section can also be inserted via push-in termination.
Strip length	9 ... 11 mm / 0.35 ... 0.43 inches
Wiring direction	Front-entry wiring

Connection 2

Solid conductor	0.25 ... 4 mm ² / 22 ... 12 AWG
Solid conductor; push-in termination	0.25 ... 4 mm ² / 22 ... 12 AWG
Fine-stranded conductor	0.25 ... 4 mm ² / 22 ... 12 AWG

Physical data

Width	7 mm / 0.276 inches
Height	81.1 mm / 3.193 inches
Depth from upper-edge of DIN-rail	49.4 mm / 1.945 inches

Mechanical data

Mounting type	DIN-35 rail
Marking level	Center/side marking

Material data

Note (material data)	Information on material specifications can be found here
Color	orange
Material group	I
Insulation material (main housing)	Polyamide (PA66)
Flammability class per UL94	V0
Fire load	0.314 MJ
Weight	15.8 g

Environmental requirements

Processing temperature	-35 ... +85 °C
Continuous operating temperature	-60 ... +105 °C

Environmental Testing

Test specification: Railway applications – Rolling stock – Electronic equipment	DIN EN 50155 (VDE 0115-200):2022-06
Test procedure: Railway applications – Rolling stock equipment – Vibration and shock tests	DIN EN 61373 (VDE 0115-0106):2011-04
Spectrum/Mounting location	Service life test, Category 1, Class A/B
Functional test with noise-like oscillations	Test passed according to Section 8 of the standard
Frequency	$f_1 = 5 \text{ Hz}$ to $f_2 = 150 \text{ Hz}$
Acceleration	0.101g (highest test level used for all axes)
Test duration per axis	10 min.
Test directions	X, Y and Z axes
Monitoring of contact faults and interruptions	Passed
Voltage drop measurement before and after each axis	Passed
Simulated service life test through increased levels of noise-like oscillations	Test passed according to Section 9 of the standard
Frequency	$f_1 = 5 \text{ Hz}$ to $f_2 = 150 \text{ Hz}$
Acceleration	0.572g (highest test level used for all axes)
Test duration per axis	5 h
Test directions	X, Y and Z axes
Extended testing: Monitoring of contact faults and interruptions	Passed
Extended testing: Voltage drop measurement before and after each axis	Passed
Shock test	Test passed according to Section 10 of the standard
Shock pulse form	Half sine
Acceleration	5g (highest test level used for all axes)
Shock duration	30 ms
Number of shocks (per axis)	3 pos. und 3 neg.
Test directions	X, Y and Z axes

Environmental Testing

Extended testing: Monitoring of contact faults and interruptions	Passed
Extended testing: Voltage drop measurement before and after each axis	Passed
Vibration and shock stress for rolling stock equipment	Passed

Commercial data

PU (SPU)	15 pcs
Packaging type	Box
Country of origin	DE
GTIN	4055143497121
Customs tariff number	85369010000

Product Classification

UNSPSC	39121410
eCl@ss 10.0	27-14-11-28
eCl@ss 9.0	27-14-11-28
ETIM 9.0	EC000900
ETIM 10.0	EC000900
ECCN	NO US CLASSIFICATION

Environmental Product Compliance

RoHS Compliance Status	Compliant, No Exemption
------------------------	-------------------------

Approvals / Certificates

General approvals



Approval	Standard	Certificate Name
CCA DEKRA Certification B.V.	EN 60947	NTR NL 7962
CSA DEKRA Certification B.V.	C22.2	2130762
KEMA/KEUR DEKRA Certification B.V.	EN 60947	71-125928
UL Underwriters Laboratories Inc.	UL 1059	E45172

Declarations of conformity and manufacturer's declarations



Approval	Standard	Certificate Name
EU-Declaration of Conformity WAGO GmbH & Co. KG	-	-
Railway WAGO GmbH & Co. KG	-	Railway Ready
UK-Declaration of Conformity WAGO GmbH & Co. KG	-	-

Downloads

Environmental Product Compliance

Compliance Search

Environmental Product Compliance 2000-5352



Documentation

Bid Text

2000-5352	07.08.2018	docx 15.00 KB	
2000-5352	19.02.2019	xml 3.92 KB	

CAD/CAE-Data

CAD data

2D/3D Models
2000-5352



CAE data

EPLAN Data Portal
2000-5352



ZUKEN Portal
2000-5352



1 Compatible Products

1.1 Required Accessories

1.1.1 End plate

1.1.1.1 End plate



Item No.: 2000-5391

End and intermediate plate; 1 mm thick; for 3-conductor terminal blocks; gray

1.2 Optional Accessories

1.2.1 DIN-rail

1.2.1.1 Mounting accessories



Item No.: 210-196

Aluminum carrier rail; 35 x 8.2 mm; 1.6 mm thick; 2 m long; unslotted; similar to EN 60715; silver-colored



Item No.: 210-198

Copper carrier rail; 35 x 15 mm; 2.3 mm thick; 2 m long; unslotted; according to EN 60715; copper-colored



Item No.: 210-197

Steel carrier rail; 35 x 15 mm; 1.5 mm thick; 2 m long; slotted; similar to EN 60715; silver-colored



Item No.: 210-114

Steel carrier rail; 35 x 15 mm; 1.5 mm thick; 2 m long; unslotted; similar to EN 60715; silver-colored



Item No.: 210-118

Steel carrier rail; 35 x 15 mm; 2.3 mm thick; 2 m long; unslotted; according to EN 60715; silver-colored



Item No.: 210-115

Steel carrier rail; 35 x 7.5 mm; 1 mm thick; 2 m long; slotted; according to EN 60715; "Hole width 18 mm; silver-colored



Item No.: 210-112

Steel carrier rail; 35 x 7.5 mm; 1 mm thick; 2 m long; slotted; according to EN 60715; "Hole width 25 mm; silver-colored



Item No.: 210-113

Steel carrier rail; 35 x 7.5 mm; 1 mm thick; 2 m long; unslotted; according to EN 60715; silver-colored

1.2.2 Ferrule

1.2.2.1 Ferrule



Item No.: 216-241

Ferrule; Sleeve for 0.5 mm² / 20 AWG; insulated; electro-tin plated; electrolytic copper; gastight crimped; acc. to DIN 46228, Part 4/09.90; white



Item No.: 216-242

Ferrule; Sleeve for 0.75 mm² / 18 AWG; insulated; electro-tin plated; electrolytic copper; gastight crimped; acc. to DIN 46228, Part 4/09.90; gray



Item No.: 216-243

Ferrule; Sleeve for 1 mm² / AWG 18; insulated; electro-tin plated; electrolytic copper; gastight crimped; acc. to DIN 46228, Part 4/09.90; red

1.2.3 Installation

1.2.3.1 Cover



Item No.: 709-156

Cover; Type 3; suitable for cover carrier, type 3; 1 m long; transparent

1.2.3.2 Cover carrier



Item No.: 709-169

Cover carrier; Type 3; incl. fixing/retaining screws and knurled nut; suitable for 279 to 282 and 880 Series rail-mounted terminal blocks; suitable for 264 Series miniature rail-mounted terminal blocks; suitable for 270 Series sensor and actuator terminal blocks; gray

1.2.4 Jumper

1.2.4.1 Jumper



Item No.: 2000-406/020-000

Delta jumper; insulated; light gray



Item No.: 2000-410/000-006

Jumper; 10-way; insulated; blue



Item No.: 2000-410

Jumper; 10-way; insulated; light gray



Item No.: 2000-410/000-005

Jumper; 10-way; insulated; red



Item No.: 2000-402/000-006

Jumper; 2-way; insulated; blue



Item No.: 2000-402

Jumper; 2-way; insulated; light gray



Item No.: 2000-402/000-005

Jumper; 2-way; insulated; red



Item No.: 2000-402/000-018

Jumper; 2-way; insulated; yellow-green



Item No.: 2000-403/000-006

Jumper; 3-way; insulated; blue



Item No.: 2000-403

Jumper; 3-way; insulated; light gray



Item No.: 2000-403/000-005

Jumper; 3-way; insulated; red



Item No.: 2000-404/000-006

Jumper; 4-way; insulated; blue



Item No.: 2000-404

Jumper; 4-way; insulated; light gray



Item No.: 2000-404/000-005

Jumper; 4-way; insulated; red



Item No.: 2000-405/000-006

Jumper; 5-way; insulated; blue



Item No.: 2000-405

Jumper; 5-way; insulated; light gray



Item No.: 2000-405/000-005

Jumper; 5-way; insulated; red



Item No.: 2000-406/000-006

Jumper; 6-way; insulated; blue



Item No.: 2000-406

Jumper; 6-way; insulated; light gray



Item No.: 2000-406/000-005

Jumper; 6-way; insulated; red



Item No.: 2000-407/000-006

Jumper; 7-way; insulated; blue



Item No.: 2000-407

Jumper; 7-way; insulated; light gray



Item No.: 2000-407/000-005

Jumper; 7-way; insulated; red



Item No.: 2000-408/000-006

Jumper; 8-way; insulated; blue

1.2.4.1 Jumper



Item No.: 2000-408
Jumper; 8-way; insulated; light gray



Item No.: 2000-408/000-005
Jumper; 8-way; insulated; red



Item No.: 2000-409/000-006
Jumper; 9-way; insulated; blue



Item No.: 2000-409
Jumper; 9-way; insulated; light gray



Item No.: 2000-409/000-005
Jumper; 9-way; insulated; red



Item No.: 2000-440
Jumper; from 1 to 10; insulated; light gray



Item No.: 2000-433/000-006
Jumper; from 1 to 3; insulated; blue



Item No.: 2000-433
Jumper; from 1 to 3; insulated; light gray



Item No.: 2000-433/000-005
Jumper; from 1 to 3; insulated; red



Item No.: 2000-434
Jumper; from 1 to 4; insulated; light gray



Item No.: 2000-435
Jumper; from 1 to 5; insulated; light gray



Item No.: 2000-436
Jumper; from 1 to 6; insulated; light gray



Item No.: 2000-437
Jumper; from 1 to 7; insulated; light gray



Item No.: 2000-438
Jumper; from 1 to 8; insulated; light gray



Item No.: 2000-439
Jumper; from 1 to 9; insulated; light gray



Item No.: 2000-405/011-000
Star point jumper; 3-way; insulated; light gray



Item No.: 210-103
Wire commoning chain; insulated; black



Item No.: 210-123
Wire commoning chain; insulated; blue

1.2.5 Marking

1.2.5.1 Marker



Item No.: 793-3501
WMB marking card; as card; plain; snap-on type; white



Item No.: 2009-113/000-006
WMB-Inline; for Smart Printer; 2300 pieces on roll; plain; snap-on type; blue



Item No.: 2009-113/000-007
WMB-Inline; for Smart Printer; 2300 pieces on roll; plain; snap-on type; gray



Item No.: 2009-113/000-023
WMB-Inline; for Smart Printer; 2300 pieces on roll; plain; snap-on type; green



Item No.: 2009-113/000-017
WMB-Inline; for Smart Printer; 2300 pieces on roll; plain; snap-on type; light green



Item No.: 2009-113/000-012
WMB-Inline; for Smart Printer; 2300 pieces on roll; plain; snap-on type; orange



Item No.: 2009-113/000-005
WMB-Inline; for Smart Printer; 2300 pieces on roll; plain; snap-on type; red



Item No.: 2009-113/000-024
WMB-Inline; for Smart Printer; 2300 pieces on roll; plain; snap-on type; violet



Item No.: 2009-113
WMB-Inline; for Smart Printer; 2300 pieces on roll; plain; snap-on type; white



Item No.: 2009-113/000-002
WMB-Inline; for Smart Printer; 2300 pieces on roll; plain; snap-on type; yellow

1.2.5.2 Marking strip



Item No.: 2009-110
Marking strips; for Smart Printer; on reel; not stretchable; plain; snap-on type; white

1.2.6 Protective warning marker

1.2.6.1 Cover



Item No.: 2000-115

Protective warning marker; for 5 terminal blocks; with high-voltage symbol, black; yellow

1.2.7 Push-in type wire jumper

1.2.7.1 Jumper



Item No.: 2009-404

Push-in type wire jumper; 0.75 mm²; insulated; 110 mm long; gray



Item No.: 2009-406

Push-in type wire jumper; 0.75 mm²; insulated; 250 mm long; gray



Item No.: 2009-402

Push-in type wire jumper; 0.75 mm²; insulated; 60 mm long; gray

1.2.8 Screwless end stop

1.2.8.1 Mounting accessories



Item No.: 249-117

Screwless end stop; 10 mm wide; for DIN-rail 35 x 15 and 35 x 7.5; gray



Item No.: 249-116

Screwless end stop; 6 mm wide; for DIN-rail 35 x 15 and 35 x 7.5; gray

1.2.9 Test and measurement

1.2.9.1 Testing accessories



Item No.: 2009-174

Test plug adapter; for 4 mm Ø test plugs; for testing TOPJOB®S rail-mounted terminal blocks; gray



Item No.: 2009-182

Testing tap; for max. 2.5 mm²; tool-free connection for individual test wires 0.08 - 2.5 mm; gray

1.2.10 Tool

1.2.10.1 Operating tool



Item No.: 210-719

Operating tool; Blade: 2.5 x 0.4 mm; with a partially insulated shaft



Item No.: 210-648

Operating tool; Blade: 2.5 x 0.4 mm; with a partially insulated shaft; angled; short



Item No.: 210-647

Operating tool; Blade: 2.5 x 0.4 mm; with a partially insulated shaft; multicoloured

Installation Notes

Conductor termination

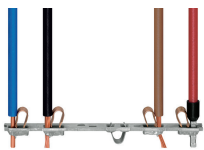

All conductor types at a glance

Commoning

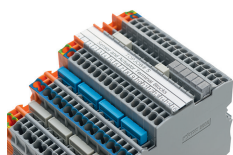

Commoning (signal level):
Commoning the signal level with push-in type jumper bars (2000 Series). Models with an LED can only be commoned in one jumper slot!
TOPJOB® S Test Plug Adapters can be used in all jumper slots.



Upper level: Two independent signal pathways

Commoning

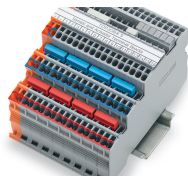

Commoning (potential level):
Commoning potential levels via push-in type jumper bars (2000 Series).

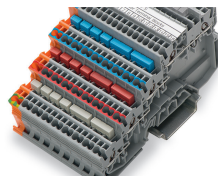

Commoning (potential level):
Continuous commoning in the potential levels via push-in type jumper bars for even pole numbers (2000 Series)



Potential levels: Two adjacent commoning options on a current bar

Commoning

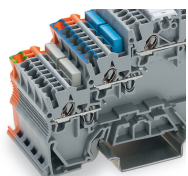

Ground commoning:
For sensor and actuator terminal blocks without ground connection to the DIN-rail, the ground connection can be performed by commoning to the terminal block with a ground foot.



For example, colored push-in type jumper bars are used with sensor terminal blocks.

Testing



Testing via testing tap (2009-182) (up to max. 42 V).



Testing via testing tap (2009-174) (up to max. 42 V).

Application

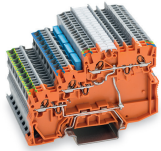

Supply:

Orange supply terminal block of same profile with a power supply option from both the cabinet and sensor sides



Terminal block assembly with 4-conductor sensor terminal blocks and 3-conductor actuator terminal blocks

Marking



Marking:

3.5 mm WMB markers (793-35xx) from the top or the side – additional marking option via marker carrier

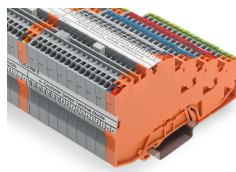

Marking:

Labeling via marking strips (2009-110) – from the top or the side.