

Data Sheet | Item Number: 280-560/281-434

3-conductor sensor terminal block; LED (red); for PNP-(high-side) switching sensors; with colored conductor entries; 2.5 mm²; CAGE CLAMP®; 2,50 mm²; gray

<https://www.wago.com/280-560/281-434>

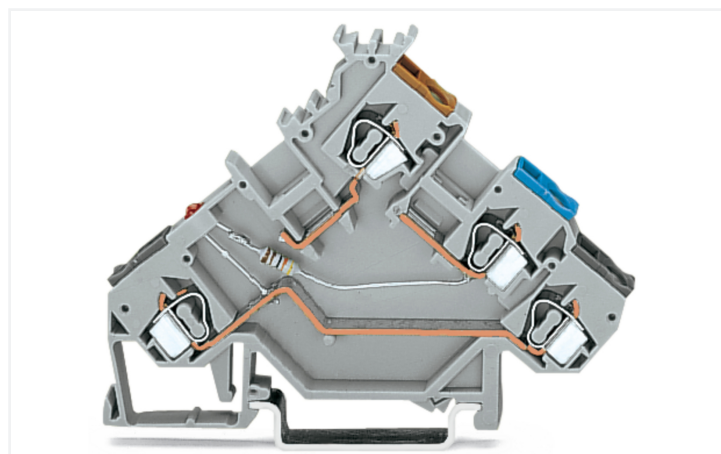
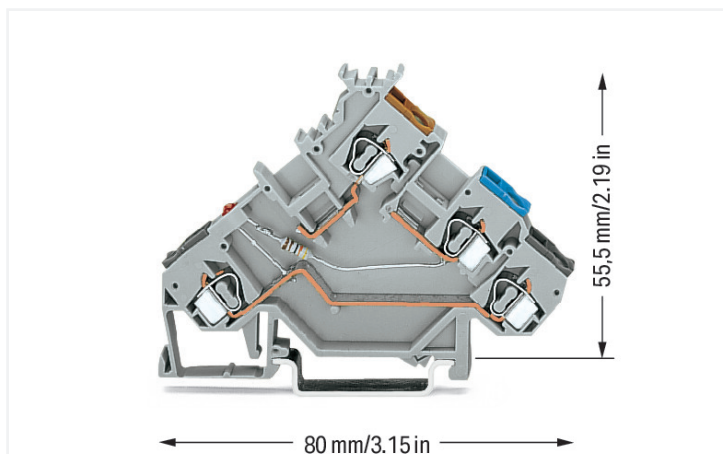

Color: ■ gray

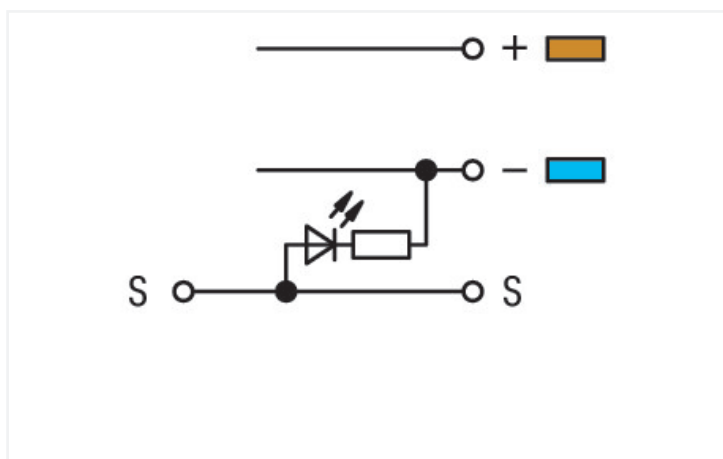

Sensor terminal block, 280 Series, operating tool

Enjoy seamless electrical installations with this sensor terminal block (item number 280-560/281-434). Conductors can only be connected to this sensor terminal block if their strip length is between 8 and 9 mm. This product features conductor terminals and utilizes CAGE CLAMP®. Our highly-rated and maintenance-free CAGE CLAMP® connection makes it easy to connect all conductor types without having to prepare the conductor. For example, you don't need to crimp ferrules. This sensor terminal block is suitable for conductor cross sections ranging from 0.08 mm² to 2.5 mm².

Electrical data

Ratings per IEC/EN

Rated current 20 A

Ratings per IEC/EN – Notes

Rated current (note) LED power consumption: 4.8 mA

Power Loss

Power loss, per pole (potential) 0.532 W

Rated current I_N for power loss specification 20 A

Resistance value for specified, current-dependent power loss 0.00133 Ω

General information

Voltage type 1 DC

Nominal voltage 24 V

LED (switching) for PNP

Wiring direction Front-entry wiring

Connection Data

Clamping units	4
Total number of potentials	3
Number of levels	3

Connection 1

Connection technology	CAGE CLAMP®
Actuation type	Operating tool
Connectable conductor materials	Copper Aluminum

Connectable conductor materials (note) **Terminating Aluminum Conductors**
WAGO Spring-Clamp Terminal Blocks are suitable for solid aluminum conductors up to 4 mm²/12 AWG if WAGO "Alu-Plus" Contact Paste [249-130](#) is used for termination.

"Alu-Plus" Contact Paste Advantages:

- Automatically destroys the oxide film during clamping.
- Prevents fresh oxidation at the clamping point.
- Prevents electrolytic corrosion between aluminum and copper conductors (in the same terminal block).
- Provides long-term protection against corrosion.

Using terminal blocks with CAGE CLAMP® Spring Pressure Connection Technology, **aluminum conductors must first be cleaned with a blade** and then immediately inserted into the clamping units filled with "Alu-Plus" contact paste.

It is also possible to apply WAGO "Alu-Plus" **additionally** on the whole surface of the aluminum conductor before termination.

Please note that the nominal currents must be adapted to the reduced conductivity of the aluminum conductors:
2.5 mm² = 16 A
4 mm² = 22 A

Solid conductor	0.08 ... 2.5 mm ² / 28 ... 12 AWG
Fine-stranded conductor	0.08 ... 2.5 mm ² / 28 ... 12 AWG
Note (conductor cross-section)	12 AWG: THHN, THWN
Strip length	8 ... 9 mm / 0.31 ... 0.35 inches
Wiring direction	Front-entry wiring

Physical data

Width	5 mm / 0.197 inches
Height	80 mm / 3.15 inches
Depth from upper-edge of DIN-rail	55.5 mm / 2.185 inches

Mechanical data

Design	angled
Mounting type	DIN-35 rail
Marking level	Center marking

Material data

Note (material data)	Information on material specifications can be found here
Color	gray
Material group	I
Insulation material (main housing)	Polyamide (PA66)
Flammability class per UL94	V0
Fire load	0.178 MJ
Weight	10.5 g

Environmental requirements

Processing temperature	-35 ... +85 °C
Continuous operating temperature	-60 ... +105 °C

Commercial data

Product Group	1 (Rail Mounted Terminal Blocks)
PU (SPU)	50 pcs
Packaging type	Box
Country of origin	DE
GTIN	4045454299231
Customs tariff number	85369010000

Product Classification

UNSPSC	39121410
eCl@ss 10.0	27-14-11-28
eCl@ss 9.0	27-14-11-28
ETIM 9.0	EC000900
ETIM 10.0	EC000900
ECCN	NO US CLASSIFICATION

Environmental Product Compliance

RoHS Compliance Status	Compliant, No Exemption
------------------------	-------------------------

Approvals / Certificates

General approvals



Approval	Standard	Certificate Name
CCA DEKRA Certification B.V.	EN 60947	2160584.53
UR Underwriters Laboratories Inc.	UL 1059	E45172

Declarations of conformity and manufacturer's declarations

Approval	Standard	Certificate Name
EU-Declaration of Conformity WAGO GmbH & Co. KG	-	-
UK-Declaration of Conformity WAGO GmbH & Co. KG	-	-

Approvals for marine applications



Approval	Standard	Certificate Name
ABS American Bureau of Ship- ping	EN 60947	24-0152298-PDA
DNV GL Det Norske Veritas, Ger- manischer Lloyd	-	TAE00001V2

Downloads

Environmental Product Compliance

Compliance Search	
Environmental Product Compliance 280-560/281-434	↓

Documentation

Bid Text			
280-560/281-434	19.02.2019	xml 3.37 KB	↓
280-560/281-434	14.03.2017	doc 24.50 KB	↓

CAD/CAE-Data

CAD data	
2D/3D Models 280-560/281-434	↓

CAE data	
EPLAN Data Portal 280-560/281-434	↓
WSCAD Universe 280-560/281-434	↓
ZUKEN Portal 280-560/281-434	↓

1 Compatible Products

1.1 Required Accessories

1.1.1 End plate

1.1.1.1 End plate



Item No.: 280-319

End and intermediate plate; 1 mm thick; for triple-deck terminal blocks; gray

Item No.: 280-321

End and intermediate plate; 1 mm thick; for triple-deck terminal blocks; orange

1.2 Optional Accessories

1.2.1 DIN-rail

1.2.1.1 Mounting accessories



Item No.: 210-196

Aluminum carrier rail; 35 x 8.2 mm; 1.6 mm thick; 2 m long; unslotted; similar to EN 60715; silver-colored



Item No.: 210-198

Copper carrier rail; 35 x 15 mm; 2.3 mm thick; 2 m long; unslotted; according to EN 60715; copper-colored



Item No.: 210-508

Steel carrier rail; 35 x 15 mm; 1.5 mm thick; 2 m long; slotted; galvanized; similar to EN 60715; silver-colored



Item No.: 210-197

Steel carrier rail; 35 x 15 mm; 1.5 mm thick; 2 m long; slotted; similar to EN 60715; silver-colored



Item No.: 210-506

Steel carrier rail; 35 x 15 mm; 1.5 mm thick; 2 m long; unslotted; galvanized; similar to EN 60715; silver-colored



Item No.: 210-114

Steel carrier rail; 35 x 15 mm; 1.5 mm thick; 2 m long; unslotted; similar to EN 60715; silver-colored



Item No.: 210-118

Steel carrier rail; 35 x 15 mm; 2.3 mm thick; 2 m long; unslotted; according to EN 60715; silver-colored



Item No.: 210-115

Steel carrier rail; 35 x 7.5 mm; 1 mm thick; 2 m long; slotted; according to EN 60715; "Hole width 18 mm; silver-colored



Item No.: 210-112

Steel carrier rail; 35 x 7.5 mm; 1 mm thick; 2 m long; slotted; according to EN 60715; "Hole width 25 mm; silver-colored



Item No.: 210-504

Steel carrier rail; 35 x 7.5 mm; 1 mm thick; 2 m long; slotted; galvanized; according to EN 60715; silver-colored



Item No.: 210-113

Steel carrier rail; 35 x 7.5 mm; 1 mm thick; 2 m long; unslotted; according to EN 60715; silver-colored



Item No.: 210-505

Steel carrier rail; 35 x 7.5 mm; 1 mm thick; 2 m long; unslotted; galvanized; according to EN 60715; silver-colored

1.2.2 Ferrule

1.2.2.1 Ferrule



Item No.: 216-301

Ferrule; Sleeve for 0.25 mm² / AWG 24; insulated; electro-tin plated; yellow



Item No.: 216-302

Ferrule; Sleeve for 0.34 mm² / 22 AWG; insulated; electro-tin plated; light turquoise



Item No.: 216-201

Ferrule; Sleeve for 0.5 mm² / 20 AWG; insulated; electro-tin plated; electrolytic copper; acc. to DIN 46228, Part 4/09.90; white



Item No.: 216-101

Ferrule; Sleeve for 0.5 mm² / AWG 22; un-insulated; electro-tin plated; silver-colored



Item No.: 216-202

Ferrule; Sleeve for 0.75 mm² / 18 AWG; insulated; electro-tin plated; gray



Item No.: 216-102

Ferrule; Sleeve for 0.75 mm² / AWG 20; un-insulated; electro-tin plated; silver-colored



Item No.: 216-203

Ferrule; Sleeve for 1 mm² / AWG 18; insulated; electro-tin plated; red



Item No.: 216-103

Ferrule; Sleeve for 1 mm² / AWG 18; un-insulated; electro-tin plated



Item No.: 216-204

Ferrule; Sleeve for 1.5 mm² / AWG 16; insulated; electro-tin plated; black



Item No.: 216-104

Ferrule; Sleeve for 1.5 mm² / AWG 16; un-insulated; electro-tin plated; silver-colored

1.2.3 Installation

1.2.3.1 Cover



Item No.: 709-154

Cover; Type 2; suitable for cover carrier, type 2; 1 m long; transparent

1.2.3.2 Cover carrier



Item No.: 709-168

Cover carrier; Type 2; incl. fixing/retaining screws and knurled nut; suitable for 283 to 285 Series rail-mounted terminal blocks; suitable for 279 to 281 Series double- and triple-deck terminal blocks; suitable for 780 to 785, 775, 776 and 777 Series TOP-JOB® rail-mounted terminal blocks; suitable for 280 Series sensor and actuator terminal blocks; suitable for 282 Series disconnect/test terminal blocks for transformer circuits; gray

1.2.3.3 Mounting accessories



Item No.: 249-116

Screwless end stop; 6 mm wide; for DIN-rail 35 x 15 and 35 x 7.5; gray

1.2.4 Insulation stop

1.2.4.1 Insulation stop



Item No.: 280-470

Insulation stop; 0.08 - 0.2 mm² "s" (0.14 mm² "f-st"); 5 pieces/strip; white



Item No.: 280-471

Insulation stop; 0.25 - 0.5 mm²; 5 pieces/strip; light gray



Item No.: 280-472

Insulation stop; 0.75 - 1 mm²; 5 pieces/strip; black

1.2.5 Jumper

1.2.5.1 Jumper



Item No.: 280-490

Jumper; 10-way; insulated; gray



Item No.: 280-482

Jumper; 2-way; insulated; gray



Item No.: 280-492

Jumper; 2-way; insulated; gray



Item No.: 280-483

Jumper; 3-way; insulated; gray



Item No.: 280-484

Jumper; 4-way; insulated; gray



Item No.: 280-485

Jumper; 5-way; insulated; gray



Item No.: 280-402

Jumper; insulated; gray



Item No.: 780-452

Staggered jumper; from 1 to 2; insulated; gray



Item No.: 780-453

Staggered jumper; from 1 to 3; insulated; gray



Item No.: 780-454

Staggered jumper; from 1 to 4; insulated; gray



Item No.: 780-455







Staggered jumper; from 1 to 5; insulated; gray



Item No.: 780-456



























Staggered jumper; from 1 to 6; insulated; gray

1.2.5.1 Jumper

 <p>Item No.: 780-457 Staggered jumper; from 1 to 7; insulated; gray</p>	 <p>Item No.: 780-458 Staggered jumper; from 1 to 8; insulated; gray</p>	 <p>Item No.: 709-110 Wire commoning chain; 2.5 mm²; insulated; black</p>	 <p>Item No.: 709-111 Wire commoning chain; 2.5 mm²; insulated; black</p>
 <p>Item No.: 709-112 Wire commoning chain; 2.5 mm²; insulated; black</p>	 <p>Item No.: 210-103 Wire commoning chain; insulated; black</p>	 <p>Item No.: 210-123 Wire commoning chain; insulated; blue</p>	

1.2.6 Marking

1.2.6.1 Marker

 <p>Item No.: 793-5501/000-006 WMB marking card; as card; for terminal block width 5 - 17.5 mm; stretchable 5 - 5.2 mm; plain; snap-on type; blue</p>	 <p>Item No.: 793-5501/000-007 WMB marking card; as card; for terminal block width 5 - 17.5 mm; stretchable 5 - 5.2 mm; plain; snap-on type; gray</p>	 <p>Item No.: 793-5501/000-023 WMB marking card; as card; for terminal block width 5 - 17.5 mm; stretchable 5 - 5.2 mm; plain; snap-on type; green</p>	 <p>Item No.: 793-5501/000-017 WMB marking card; as card; for terminal block width 5 - 17.5 mm; stretchable 5 - 5.2 mm; plain; snap-on type; light green</p>
 <p>Item No.: 793-5501/000-012 WMB marking card; as card; for terminal block width 5 - 17.5 mm; stretchable 5 - 5.2 mm; plain; snap-on type; orange</p>	 <p>Item No.: 793-5501/000-005 WMB marking card; as card; for terminal block width 5 - 17.5 mm; stretchable 5 - 5.2 mm; plain; snap-on type; red</p>	 <p>Item No.: 793-5501/000-024 WMB marking card; as card; for terminal block width 5 - 17.5 mm; stretchable 5 - 5.2 mm; plain; snap-on type; violet</p>	 <p>Item No.: 793-5501 WMB marking card; as card; for terminal block width 5 - 17.5 mm; stretchable 5 - 5.2 mm; plain; snap-on type; white</p>
 <p>Item No.: 793-5501/000-002 WMB marking card; as card; for terminal block width 5 - 17.5 mm; stretchable 5 - 5.2 mm; plain; snap-on type; yellow</p>	 <p>Item No.: 793-501/000-006 WMB marking card; as card; not stretchable; plain; snap-on type; blue</p>	 <p>Item No.: 793-501/000-007 WMB marking card; as card; not stretchable; plain; snap-on type; gray</p>	 <p>Item No.: 793-501/000-023 WMB marking card; as card; not stretchable; plain; snap-on type; green</p>
 <p>Item No.: 793-501/000-017 WMB marking card; as card; not stretchable; plain; snap-on type; light green</p>	 <p>Item No.: 793-501/000-012 WMB marking card; as card; not stretchable; plain; snap-on type; orange</p>	 <p>Item No.: 793-501/000-005 WMB marking card; as card; not stretchable; plain; snap-on type; red</p>	 <p>Item No.: 793-501/000-024 WMB marking card; as card; not stretchable; plain; snap-on type; violet</p>
 <p>Item No.: 793-501 WMB marking card; as card; not stretchable; plain; snap-on type; white</p>	 <p>Item No.: 793-501/000-002 WMB marking card; as card; not stretchable; plain; snap-on type; yellow</p>	 <p>Item No.: 2009-115/000-006 WMB-Inline; for Smart Printer; 1500 pieces on roll; stretchable 5 - 5.2 mm; plain; snap-on type; blue</p>	 <p>Item No.: 2009-115/000-007 WMB-Inline; for Smart Printer; 1500 pieces on roll; stretchable 5 - 5.2 mm; plain; snap-on type; gray</p>
 <p>Item No.: 2009-115/000-023 WMB-Inline; for Smart Printer; 1500 pieces on roll; stretchable 5 - 5.2 mm; plain; snap-on type; green</p>	 <p>Item No.: 2009-115/000-017 WMB-Inline; for Smart Printer; 1500 pieces on roll; stretchable 5 - 5.2 mm; plain; snap-on type; light green</p>	 <p>Item No.: 2009-115/000-012 WMB-Inline; for Smart Printer; 1500 pieces on roll; stretchable 5 - 5.2 mm; plain; snap-on type; orange</p>	 <p>Item No.: 2009-115/000-024 WMB-Inline; for Smart Printer; 1500 pieces on roll; stretchable 5 - 5.2 mm; plain; snap-on type; violet</p>
 <p>Item No.: 2009-115 WMB-Inline; for Smart Printer; 1500 pieces on roll; stretchable 5 - 5.2 mm; plain; snap-on type; white</p>	 <p>Item No.: 2009-115/000-002 WMB-Inline; for Smart Printer; 1500 pieces on roll; stretchable 5 - 5.2 mm; plain; snap-on type; yellow</p>		

1.2.7 Protective warning marker

1.2.7.1 Cover



Item No.: 280-415

Protective warning marker; for 5 terminal blocks; with high-voltage symbol, black; yellow

1.2.8 Push-in type wire jumper

1.2.8.1 Jumper



Item No.: 249-126

Push-in type wire jumper; 0.75 mm²; insulated; 110 mm long; black



Item No.: 249-123

Push-in type wire jumper; 0.75 mm²; insulated; 180 mm long; black



Item No.: 249-127

Push-in type wire jumper; 0.75 mm²; insulated; 250 mm long; black



Item No.: 249-125

Push-in type wire jumper; insulated; 60 mm long; black

1.2.9 Test and measurement

1.2.9.1 Testing accessories



Item No.: 209-170

Test plug adapter; 8.3 mm wide; for 4 mm Ø test plugs; suitable for 1.5 mm² - 10 mm² tbs; gray

1.2.10 Tool

1.2.10.1 Operating tool



Item No.: 210-658

Operating tool; Blade: 3.5 x 0.5 mm; with a partially insulated shaft; angled; short; multicoloured



Item No.: 210-720

Operating tool; Blade: 3.5 x 0.5 mm; with a partially insulated shaft; multicoloured



Item No.: 210-657

Operating tool; Blade: 3.5 x 0.5 mm; with a partially insulated shaft; short; multicoloured

Installation Notes

Installation

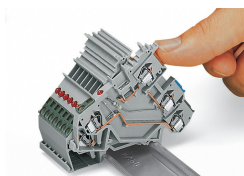

Snapping a terminal block onto the DIN-rail. Terminal blocks with a grounding foot automatically establish a direct contact to the rail.

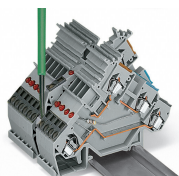

Removing the terminal block from DIN-rail. Notice: Remove jumper contacts first!

Conductor termination

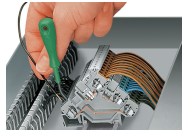
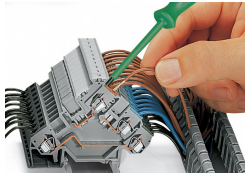

CAGE CLAMP® connection

Inserting a conductor via straight operating tool (210-720).

CAGE CLAMP® connection

Inserting a conductor via angled operating tool (210-658).

Commoning

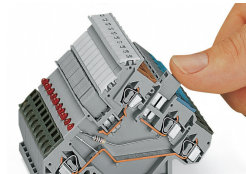

Commoning using an adjacent jumper (280-402). Push jumper down until fully inserted.

Testing

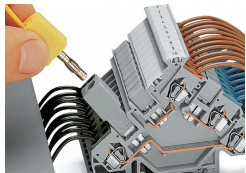

Testing via banana plug and test plug adapter (209-170).

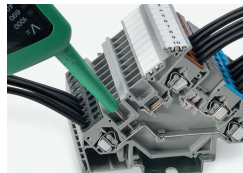

Testing via voltage tester directly on the current bar.

Application



Sensor LED terminal block with a 3-conductor sensor

Installation

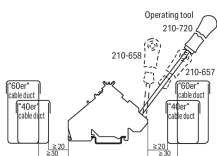

Min. mounting distance – terminal blocks to cable duct

Marking



Labeling via WMB Multi Marking System.