













36 060 670 Product version from 6/1/2024



- cover plate 80 x 80 mm
- WRAS

	Brushed Dark Platinum	36 060 670-99
	Chrome	36 060 670-00
	Brushed Platinum	36 060 670-06
	Platinum	36 060 670-08
	Dark Chrome	36 060 670-19
	Brushed Light Gold (PVD)	36 060 670-27
	Brushed Durabronze (23kt Gold)	36 060 670-28
	Matte Black	36 060 670-33
	Brushed Gold (PVD)	36 060 670-37
	Brushed Dark Brass (PVD)	36 060 670-39
	Brushed Bronze (PVD)	36 060 670-42
	Brushed Dark Bronze (PVD)	36 060 670-43
	Brushed Champagne (22kt Gold)	36 060 670-46
	Champagne (22kt Gold)	36 060 670-47
	Brushed Chrome	36 060 670-93

Required miscellaneous



Concealed wall-mounted single-lever mixer - 35 860 970 90

- min. recess depth 75 mm
- max. recess depth 95 mm

36 060 670 Product version from 6/1/2024

mm [inches]

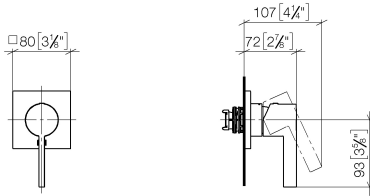

Flow rate chart

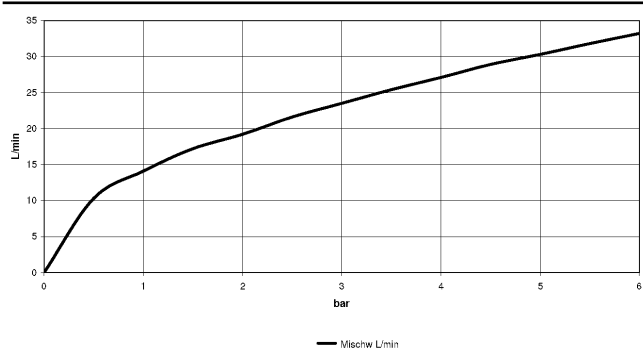

Codes & Standards

DIN 4109

ISO 3822

Scottish Water
Byelaws

UK Water Supply
Regulations

Ü-Zeichen



Concealed single-lever mixer with cover plate - Brushed Dark Platinum

SERIES SPECIFIC

36 060 670 Product version from 6/1/2024

Certificates and sustainability

LGA_29	WRAS_2107	EPD-DOR-20230287 -IBA1-EN Environmental.prod uct-declarat
--------	-----------	--

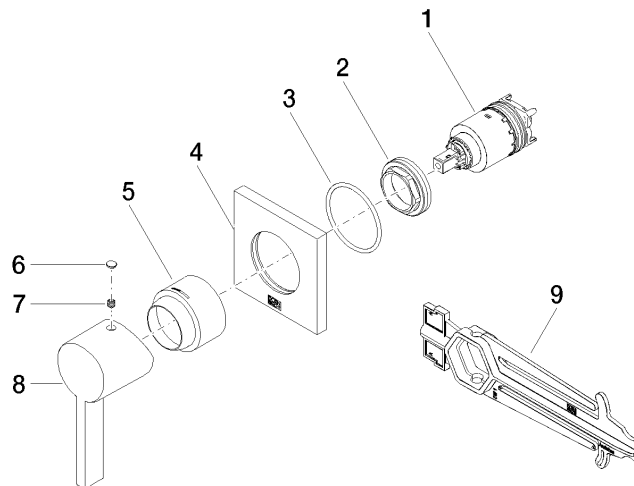

Spare parts list

No.	Item Number	Name	Quantity used	Delivery time
8	09 20 67 004-99	Handle Lever 45 x 46 x 116 mm - Brushed Dark Platinum	1.00	40
6	90 31 20 087 00-99	Plug with O-ring Ø 7 x 2,1 mm - Brushed Dark Platinum	1.00	40
1	90 15 05 064 01 90	Single-lever mixer cartridge with adapter plate incl. installation spanner Ø 35 mm x 58,6 mm -	1.00	-
Spare part can no longer be ordered, please order the replacement item				
	9015050460190	Single-lever mixer cartridge with cartridge insert , torque wrench Ø 35 mm x 58,6 mm -		
7	90 31 11 112 00 90	Mounting Threaded pin M5 x 6 mm -	1.00	14
5	09 11 02 530-99	Cover Ø 45 x 34,5 mm - Brushed Dark Platinum	1.00	40
2	09 24 04 105 90	Mounting Ø 40 x 12 mm -	1.00	14
9	90 30 09 064 00 90	Spanner for cartridge nut -	1.00	14
3	90 14 10 049 00 90	O-Ring 45,69 x 2,62 mm -	1.00	14
4	09 27 78 048-99	Rosette for mixer 80 x 80 x 9 mm - Brushed Dark Platinum	1.00	40