

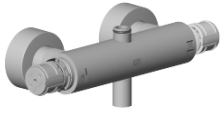













**Connection for thermostat deck mounting with 2-way diverter 281 x 126 x 104 mm - Brushed Bronze (PVD)**

SPARE PARTS

04 17 01 250 00 Product version from 4/1/2025



	Brushed Bronze (PVD)	04 17 01 250 00-42
	Chrome	04 17 01 250 00-00
	Brushed Platinum	04 17 01 250 00-06
	Platinum	04 17 01 250 00-08
	Durabronze (23kt Gold)	04 17 01 250 00-09
	Matte White	04 17 01 250 00-10
	Dark Chrome	04 17 01 250 00-19
	Light Gold (PVD)	04 17 01 250 00-26
	Brushed Light Gold (PVD)	04 17 01 250 00-27
	Brushed Durabronze (23kt Gold)	04 17 01 250 00-28
	Matte Black	04 17 01 250 00-33
	Brushed Dark Brass (PVD)	04 17 01 250 00-39
	Brushed Chrome	04 17 01 250 00-93
	Brushed Dark Platinum	04 17 01 250 00-99



Connection for thermostat deck mounting with 2-way diverter 281 x 126 x 104  
mm - Brushed Bronze (PVD)

---

SPARE PARTS

04 17 01 250 00 Product version from 4/1/2025



Connection for thermostat deck mounting with 2-way diverter 281 x 126 x 104  
mm - Brushed Bronze (PVD)

---

SPARE PARTS

04 17 01 250 00 Product version from 4/1/2025

04 17 01 250 00 Product version from 4/1/2025

Parts for other finishes can be found here: [Chrome](#)

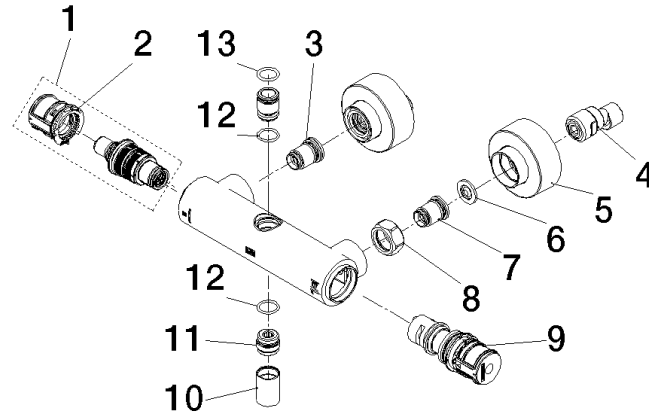

### Spare parts list

No.	Item Number	Name	Quantity used	Delivery time
	3	04 31 20 530 00 90	Insert Ø 23,5 x 27,5 mm -	1.00 14
	11	09 31 20 511-42	Nipple - Brushed Bronze (PVD)	1.00 82
	2	90 30 40 010 00 90	Controller for thermostat cartridges -	1.00 14
	1	90 15 02 070 00 90	Thermostat cartridge Ø 39 x 92 mm, 26 l/min. -	1.00 14
	7	04 31 20 540 00 90	Insert for check valve Ø 23,5 x 27,5 mm -	1.00 14
	8	09 24 77 008-00	Nut Sleeve nut Ø 33,5 x 15 mm - Chrome	2.00 20
	9	90 90 03 212 01 90	Diverter with controller 135 x 130 x 80 mm -	1.00 14
	5	90 31 20 512 00-42	Rosette two-piece 1 pair - Brushed Bronze (PVD)	2.00 40
	4	04 11 04 030 00 90	S-connection with sound damper and seal 1 pair G1/2 x G3/4 -	2.00 14
	6	09 29 30 050 90	Filter Ø 24 x 4 mm -	2.00 14
	10	90 21 02 069 00-42	Cover/sleeve M20 x 1 - Brushed Bronze (PVD)	1.00 40
	13	09 14 10 022 90	O-Ring EPDM 70 16,0 x 2,5 mm -	1.00 14
	12	90 14 10 010 00 90	O-Ring EPDM 70 17,0 x 2,0 mm -	2.00 14