

Safety Luminaire

FlexiTech SE AT

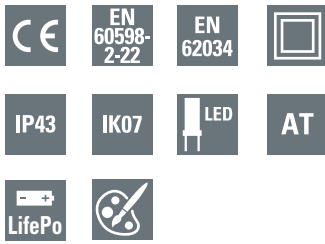

FlexiTech SE AT

- LED self-contained luminaire with Automatic Test (AT) for reduced inspection effort
- Safety luminaire, light distribution optimized for escape route application, IP43
- Non obtrusive design and slim housing (31.2 mm)
- Good lighting performance and spacing in a compact housing
- Possibility to modify the light distribution by changing the optical lens (option)
- Light output selectable in two steps in mains operation (eg. theater: 10 lm, Supermarket: 100 lm) and additional setting (30%, 70%, 100%)
- Selectable operating time (1/2/3/8h operation)
- Selectable operation mode (M or NM) via external switch
- Large working space, cable entries in flexible material and spirit level for easy and fast installation
- Transparent base plate with honeycomb footprint for easy replacement and fast installation
- Low eco footprint thanks to eco designed luminaire, low consumption and Lithium battery
- Simple fault analysis and status display via bicolor LED, testing button (magnet)
- Complete range of accessories (Recess Kit for Ceiling, Recessed Box for plaster and brick wall, Wire Guard)
- Other colours available on demand

FlexiTech SE



Dimensions in mm

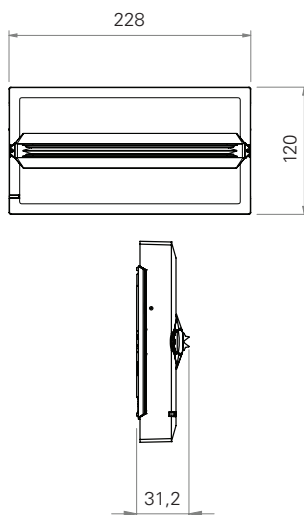

Luminous flux Φ_e/Φ_N at end of rated operating time	100% @ 1h, 58% @ 2h, 50% @ 3h, 18% @ 8h
Illumination in mains mode	10 or 100lm setting via switch, and possible additional setting via magnet (30%, 70%, 100%)
Operation	Maintained / Non-Maintained (via external switch)
Testing system	Automatic Test in compliance with EN 62034
Housing	
Type of mounting	Surface-mounting
Material	Polycarbonate
Colour	White RAL9003
Degree of protection	IP43 / IK07
Terminals	Screwless terminals for flexible and rigid wires From 0,5 to 2,5 mm ²
Connection voltage	220 - 240 V AC, 50/60 Hz
Permissible ambient temperature	5°C to 45°C, 0°C to 45°C in maintained mode
Battery	LifePo
Light source	LED
Dimensions	120 × 228 × 31.2 mm
Insulation Class	II

Ordering details

Order code	IP	IK	Duration (h)	lm in emergency				lm in mains	Operation	Consumption		Battery	Weight (kg)
				1h	2h	3h	8h			NM W/WA	M 100 lm W/WA		
FT2SE400ATL18	43	7	1/2/3/8	400	230	200	75	10 or 100	MNM	0.4W / 1VA	2W / 5 VA	FT-BAT3	0.4

Accessories

	FT2-RKC	Recess Kit for Ceiling, compatible with FlexiTech SE and FlexiTech ED (ceiling position)
	FT2-WG	Wire Guard, compatible with FlexiTech SE and FlexiTech ED
	FT2SE-RB	Recessed Box for plaster and brick compatible with FlexiTech SE
	FT2SE-LO	Lens with light distribution optimized for Open area, compatible with FlexiTech SE
	40071352379	Eaton Magnet for lighting configuration and manual tests
	FT-BAT3	Battery Pack, LifePo 3,2 V / 3 Ah

FlexiTech SE - Spacing data for flux value: 75 lm

400 lumens AT variant configured @8 hours

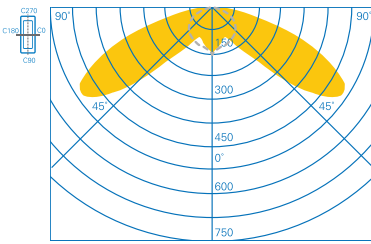

Light distribution curve

FlexiTech SE, asymmetric distribution : 1 lux (0.5 lux)

Ceiling mounting, measurement at floor level, battery operation ,distances in m

Escape route illumination

Mounting height [m]	Lux level directly under				
2,5		1,2 (2,2)	4,4 (6,1)	0,8 (4,7)	7,6 (11,7)
3,0		0,6 (2,0)	4,0 (6,2)	0,3 (5,0)	6,7 (12,6)

Open area illumination

Mounting height [m]	Lux level directly under				
2,5		0,5 (0,7)	4,4 (6,1)	1,1 (5,1)	10,3 (12,2)
3,0		0,5 (0,5)	4,7 (6,3)	0,7 (1,4)	7,8 (13,4)
3,5		0,7 (0,5)	4,9 (6,2)	0,5 (1,5)	7,3 (14,5)
4,0		0,5 (0,6)	5,1 (6,6)	0,5 (0,8)	6,7 (11,3)

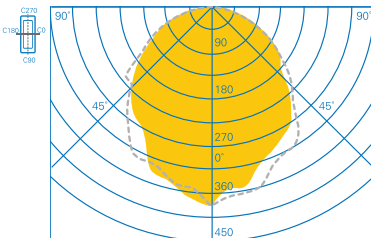

Light distribution curve

FlexiTech SE, with optional lens for open area, symmetric distribution : 1 lux (0.5 lux)

Ceiling mounting, measurement at floor level, battery operation ,distances in m

Escape route illumination

Mounting height [m]	Lux level directly under				
2,5	4	2,4 (3,2)	6,4 (8,1)	2,4 (3,2)	6,5 (8,2)
3,0	2,8	2,4 (3,3)	6,7 (8,6)	2,4 (3,3)	6,7 (8,7)
3,5	2	2,3 (3,4)	6,8 (9,0)	2,2 (3,4)	6,8 (9,1)
4,0	1,5	2,1 (3,5)	6,9 (9,4)	1,9 (3,4)	6,9 (9,4)

Open area illumination

Mounting height [m]	Lux level directly under				
2,5		2,1 (2,6)	5,7 (7,1)	2,1 (2,5)	5,6 (7,0)
3,0		2,1 (2,6)	6,2 (7,6)	1,9 (2,6)	5,9 (7,5)
3,5		1,9 (2,6)	6,3 (8,0)	2,0 (2,7)	6,3 (8,0)
4,0		1,8 (2,7)	6,6 (8,4)	1,8 (2,7)	6,5 (8,3)
4,5		1,5 (2,6)	6,7 (8,7)	1,6 (2,7)	6,7 (8,7)
5,0		1,2 (2,5)	6,9 (9,0)	1,3 (2,6)	6,7 (8,9)
5,5		0,8 (2,4)	7,1 (9,2)	0,7 (2,5)	6,5 (9,1)
6,0		0,5 (2,2)	6,9 (9,4)	0,7 (2,3)	6,3 (9,3)
6,5		0,8 (1,8)	7,1 (9,5)	0,5 (2,0)	5,4 (9,5)

FlexiTech SE - Spacing data for flux value: 200 lm

400 lumens AT variant configured @3 hours

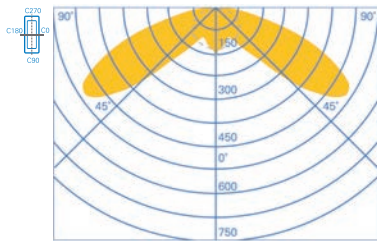

Light distribution curve

FlexiTech SE, asymmetric distribution : 1 lux (0.5 lux)

Ceiling mounting, measurement at floor level, battery operation, distances in m

Escape route illumination

Mounting height [m]	Lux level directly under				
2,5	4	2,6 (3,4)	6,8 (8,6)	5,2 (6,3)	12,6 (15,2)
3,0	2,5	2,5 (3,5)	7,1 (9,1)	5,5 (6,9)	13,7 (16,6)
3,5	1	2,3 (3,6)	7,2 (9,6)	5,8 (7,3)	14,6 (17,8)
4,0		2,0 (3,6)	7,2 (9,9)	1,4 (7,7)	12,9 (18,9)

Open area illumination

Mounting height [m]	Lux level directly under				
2,5		0,6 (0,8)	6,8 (8,6)	5,5 (6,5)	13,2 (15,7)
3,0		0,6 (0,7)	7,2 (9,2)	0,9 (7,1)	14,4 (17,2)
3,5		0,8 (0,8)	7,3 (9,7)	1,6 (1,2)	15,5 (18,5)
4,0		0,6 (0,7)	7,3 (10,0)	1,2 (8,0)	16,6 (19,8)
4,5		1,1 (0,6)	7,7 (10,2)	0,5 (2,2)	13,2 (21,0)
5,0		0,6 (0,6)	7,8 (10,4)	0,6 (1,1)	12,5 (22,1)
5,5		1,0 (0,5)	8,0 (10,3)	0,5 (1,8)	12,0 (23,2)
6,0		0,5 (0,5)	8,0 (10,5)	0,5 (1,2)	11,8 (20,4)
6,5		0,5 (0,5)	8,4 (10,9)	0,5 (0,5)	10,9 (18,4)
7,0		0,5 (0,7)	6,6 (11,0)	0,9 (0,6)	11,8 (17,7)
7,5		0,5 (0,7)	4,9 (11,1)	0,9 (0,5)	12,5 (17,3)

FlexiTech SE - Spacing data for flux value: 200 lm

400 lumens AT variant configured @3 hours

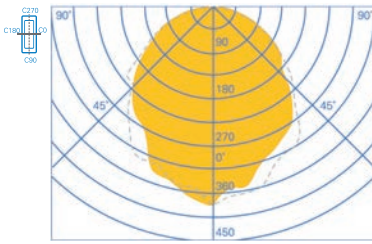

Light distribution curve

FlexiTech SE, with optional lens for open area, symmetric distribution : 1 lux (0.5 lux)

Ceiling mounting, measurement at floor level, battery operation, distances in m

Escape route illumination

Mounting height [m]	Lux level directly under				
2,5	10	3,5 (4,4)	8,8 (10,8)	3,6 (4,5)	9,0 (11,1)
3,0	7	3,7 (4,7)	9,4 (11,7)	3,8 (4,8)	9,6 (11,9)
3,5	5	3,9 (5,0)	9,9 (12,4)	3,9 (5,1)	10,1 (12,6)
4,0	4	3,9 (5,2)	10,4 (13,1)	3,9 (5,3)	10,5 (13,3)
4,5	3	4,0 (5,4)	10,8 (13,6)	4,0 (5,4)	10,8 (13,9)
5,0	2,5	4,0 (5,5)	11,0 (14,1)	3,9 (5,5)	11,0 (14,4)
5,5	2	3,9 (5,5)	11,1 (14,6)	3,7 (5,5)	11,1 (14,8)
6,0		3,7 (5,6)	11,2 (15,0)	3,4 (5,6)	11,2 (15,1)
6,5		3,5 (5,6)	11,3 (15,3)	3,2 (5,6)	11,2 (15,3)
7,0		3,2 (5,6)	11,2 (15,5)	2,8 (5,5)	11,1 (15,5)

Open area illumination

Mounting height [m]	Lux level directly under				
2,5		2,8 (3,4)	7,7 (9,3)	2,8 (3,4)	7,6 (9,3)
3,0		2,9 (3,6)	8,3 (10,1)	2,9 (3,6)	8,2 (10,1)
3,5		2,9 (3,7)	8,8 (10,8)	3,0 (3,7)	8,8 (10,8)
4,0		3,0 (3,9)	9,2 (11,4)	3,1 (3,9)	9,2 (11,4)
4,5		3,0 (4,0)	9,6 (12,0)	3,1 (4,0)	9,6 (11,9)
5,0		3,1 (4,0)	10,1 (12,5)	2,9 (4,1)	9,8 (12,4)
5,5		2,9 (4,0)	10,2 (12,9)	3,1 (4,2)	10,2 (12,9)
6,0		2,8 (4,0)	10,5 (13,3)	2,9 (4,2)	10,4 (13,3)
6,5		2,6 (4,1)	10,7 (13,7)	2,7 (4,1)	10,6 (13,6)
7,0		2,4 (4,0)	10,9 (14,0)	2,5 (4,1)	10,8 (14,0)
7,5		2,0 (3,9)	11,0 (14,3)	2,3 (4,1)	11,0 (14,3)
8,0		1,7 (3,9)	11,1 (14,6)	2,0 (4,0)	11,0 (14,5)
8,5		1,0 (3,6)	11,1 (14,8)	1,8 (3,9)	11,1 (14,8)
9,0		0,7 (3,5)	11,4 (15,0)	1,1 (3,8)	10,8 (15,0)

FlexiTech SE - Spacing data for flux value: 400 lm

400 lumens AT variants configured @1 hour

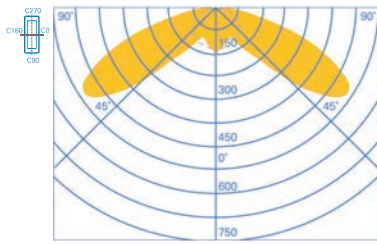

Light distribution curve

FlexiTech SE, asymmetric distribution : 1 lux (0.5 lux)

Ceiling mounting, measurement at floor level, battery operation, distances in m

Escape route illumination

Mounting height [m]	Lux level directly under				
2,5	8	3,4 (4,3)	8,6 (10,4)	6,3 (7,6)	15,2 (18,1)
3	5,8	3,5 (4,6)	9,1 (11,3)	6,9 (8,3)	16,6 (19,8)
3,5	4	3,6 (4,8)	9,6 (12,1)	7,3 (8,9)	17,8 (21,4)
4		3,6 (4,9)	9,9 (12,7)	7,7 (9,5)	18,9 (22,8)
4,5		3,4 (5,1)	10,1 (13,2)	8,0 (10,0)	19,9 (24,1)
5		3,2 (5,1)	10,2 (13,6)	8,1 (10,4)	20,8 (25,3)
5,5		2,9 (5,1)	10,2 (13,9)	2,1 (10,7)	19,7 (26,4)

Open area illumination

Mounting height [m]	Lux level directly under				
2,5		0,9 (0,9)	8,6 (10,5)	6,5 (7,6)	15,7 (18,7)
3,0		0,8 (1,2)	9,2 (11,4)	7,1 (8,3)	17,2 (20,4)
3,5		0,6 (0,9)	9,7 (12,2)	7,5 (8,9)	18,6 (22,1)
4,0		0,8 (0,6)	10,0 (12,8)	8,0 (9,5)	19,8 (23,7)
4,5		0,9 (0,6)	10,3 (13,3)	1,0 (10,1)	20,9 (25,1)
5,0		0,7 (0,7)	10,4 (13,7)	1,2 (10,5)	22,1 (26,4)
5,5		0,5 (0,5)	10,4 (14,1)	1,2 (1,4)	23,2 (27,7)
6,0		1,0 (0,5)	10,6 (14,3)	0,9 (11,5)	20,4 (28,9)
6,5		0,5 (0,7)	10,9 (14,5)	0,6 (2,6)	18,5 (30,0)
7,0		0,6 (0,7)	11,0 (14,7)	0,6 (1,3)	17,8 (31,1)
7,5		0,6 (0,6)	11,1 (14,7)	0,5 (1,6)	17,4 (32,2)
8,0		1,8 (0,5)	11,8 (14,5)	0,5 (2,2)	16,2 (33,3)
8,5		0,5 (0,6)	11,3 (15,0)	0,5 (0,9)	16,7 (28,6)

FlexiTech SE - Spacing data for flux value: 400 lm

400 lumens AT variants configured @1 hour

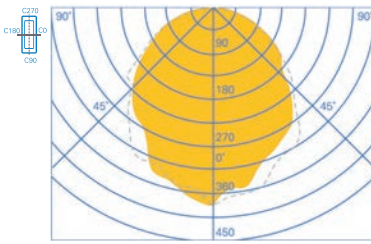

Light distribution curve

FlexiTech SE, with optional lens for open area, symmetric distribution : 1 lux (0.5 lux)

Ceiling mounting, measurement at floor level, battery operation ,distances in m

Escape route illumination

Mounting height [m]	Lux level directly under				
2,5	20	4,4 (5,4)	10,8 (13,0)	4,5 (5,5)	11,1 (13,5)
3,0	15	4,7 (5,8)	11,7 (14,1)	4,8 (6,0)	11,9 (14,6)
3,5	10	5,0 (6,2)	12,4 (15,2)	5,1 (6,3)	12,6 (15,6)
4,0	7,5	5,2 (6,5)	13,1 (16,1)	5,3 (6,6)	13,3 (16,5)
4,5	6	5,4 (6,8)	13,6 (16,9)	5,4 (6,9)	13,9 (17,3)
5,0	5	5,5 (7,1)	14,1 (17,7)	5,5 (7,2)	14,4 (18,0)
5,5	4	5,5 (7,3)	14,6 (18,3)	5,5 (7,4)	14,8 (18,6)
6,0	3,5	5,6 (7,5)	15,0 (18,9)	5,6 (7,5)	15,1 (19,2)
6,5	3	5,6 (7,6)	15,3 (19,4)	5,6 (7,6)	15,3 (19,8)
7,0	2,5	5,6 (7,7)	15,5 (19,9)	5,5 (7,7)	15,5 (20,3)
7,5	2,3	5,5 (7,8)	15,6 (20,4)	5,4 (7,8)	15,6 (20,7)
8,0	2	5,4 (7,9)	15,7 (20,8)	5,1 (7,9)	15,7 (21,0)
8,5	1,7	5,2 (7,9)	15,9 (21,2)	4,9 (7,9)	15,8 (21,3)
9,0	1,5	5,0 (8,0)	15,9 (21,5)	4,6 (7,9)	15,9 (21,5)

Open area illumination

Mounting height [m]	Lux level directly under				
2,5		3,4 (4,1)	9,3 (11,3)	3,4 (3,9)	9,3 (11,2)
3,0		3,6 (4,4)	10,1 (12,3)	3,6 (4,2)	10,1 (12,2)
3,5		3,8 (4,6)	10,8 (13,1)	3,7 (4,5)	10,8 (13,1)
4,0		3,9 (4,8)	11,4 (14,0)	3,9 (4,7)	11,4 (13,9)
4,5		3,9 (5,0)	12,0 (14,7)	4,0 (4,9)	12,0 (14,6)
5,0		3,9 (5,1)	12,5 (15,4)	4,1 (5,0)	12,5 (15,3)
5,5		4,0 (5,3)	13,0 (16,0)	4,1 (5,2)	12,9 (15,9)
6,0		4,1 (5,3)	13,4 (16,6)	4,1 (5,3)	13,3 (16,5)
6,5		4,0 (5,3)	13,7 (17,1)	4,2 (5,5)	13,7 (17,1)
7,0		4,6 (5,3)	14,8 (17,6)	3,5 (5,6)	13,3 (17,6)
7,5		3,9 (5,4)	14,3 (18,1)	4,1 (5,6)	14,3 (18,0)
8,0		4,0 (5,5)	14,8 (18,5)	3,8 (5,6)	14,4 (18,4)
8,5		3,7 (5,5)	14,8 (18,9)	4,0 (5,7)	14,8 (18,8)
9,0		3,5 (5,5)	15,0 (19,2)	3,8 (5,7)	15,0 (19,2)
9,5		3,3 (5,5)	15,2 (19,6)	3,6 (5,6)	15,2 (19,5)
10,0		3,1 (6,1)	15,5 (20,7)	3,3 (4,9)	15,3 (19,1)