

Technical data sheet

End clamp for PV module mounting, free-standing system

Item number: 5901072

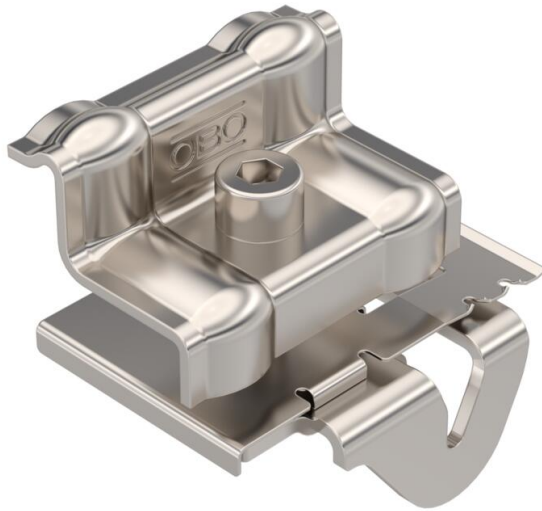

End clamp for fastening photovoltaic modules on support profiles of free-standing systems. Lockable pre-fastening of the module frames on the support profile. Suitable for slot width 10 mm. Lockable fastening of the PV module with Torx 30 wrench.



A2 Stainless steel

Master data

Item number	5901072
Type	KLE 25 A2
Description 1	End clamp
Description 2	for free-standing system
Manufacturer	OBO
Dimension	60x70x54
Colour	stainless steel
Material	Stainless steel 1.4301
Smallest sales unit	50
Unit of quantity	Piece
Weight	16.9 kg
Weight unit	kg/100 pc.
CO2 Footprint (GWP) Cradle-to-Gate	0,8409 kg CO2e / 1 Piece

Technical data sheet

End clamp for PV module mounting, free-standing system

Item number: 5901072



Dimensions

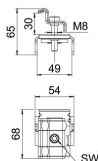

Width	54 mm
Height	65 mm

Technical data

With fastening material	no
Depth	68.5 mm
Adjustable	no
Photovoltaic connection and fastening element version	End terminal
For frame height min.	25 mm
With module earthing	no