

# Productinformatieblad

Specificaties



## XB5, Kop voor keuzeschakelaar, 2 pos, Terugvering R naar L, Lange hendel

ZB5FJ4

EAN Code: 3606481340269

**Prijs: 15,45 EUR**

### Hoofd

range of product	Harmony XB5
product of component type	Kop voor keuzeschakelaar
device short name	ZB5
kraag materiaal	Donkergrijs kunststof
bevestigingsdiameter	30,5 mm
koptype	Built-in-flush
verkoop per ondeelbare hoeveelheid	1
vorm van kop signaleringseenheid	Rond
type operator	Van rechts naar links terugverend
operator profiel	Zwart lange hendel
extra informatie operator	Niet vergrendelbaar met hangslot
informatie positie operator	2 standen 90°

### Complementair

CAD totale breedte	37 mm
CAD totale hoogte	37 mm
CAD totale diepte	46 mm
gewicht product	0,031 kg
mechanical durability	1000000 cycles
elektrische samenstellingscode	C3 voor <6 contacten gebruik enkelvoudig blokken in vooraan gemonteerd C4 voor <6 contacten gebruik enkelvoudig en dubbel blokken in vooraan gemonteerd C5 voor <5 contacten gebruik enkelvoudig blokken in vooraan gemonteerd C6 voor <5 contacten gebruik enkelvoudig en dubbel blokken in vooraan gemonteerd C7 voor <4 contacten gebruik enkelvoudig blokken in vooraan gemonteerd C8 voor <4 contacten gebruik enkelvoudig en dubbel blokken in vooraan gemonteerd C11 voor <3 contacten gebruik enkelvoudig blokken in vooraan gemonteerd C15 voor <1 contacten gebruik enkelvoudig blokken in vooraan gemonteerd SF1 voor <3 contacten gebruik enkelvoudig blokken in vooraan gemonteerd

### Omgeving

beschermende behandeling	TH
ambient air temperature for storage	-40...70 °C
omgevingstemperatuur voor werking	-40...70 °C
overvoltage category	Klasse II In overeenstemming met IEC 60536

De weergegeven prijs is de adviesprijs in euro excl. BTW. Deze kan onderhevig zijn aan korting. Neem contact op met uw lokale distributeur of detailhandel voor de daadwerkelijke prijs

<b>IP beschermingsgraad</b>	IP66 In overeenstemming met IEC 60529 IP67 In overeenstemming met IEC 60529 IP69K IP69
<b>Enclosure Type</b>	UL type 4X/13
<b>weerstand hoge druk drukring</b>	7000000 Pa om 55 °C, afstand: 0.1 m
<b>IK-beschermingsgraad</b>	IK03 In overeenstemming met IEC 50102
<b>standards</b>	IEC 60947-1 JIS C8201-5-1 UL 508 IEC 60947-5-1 CSA C22.2 Nr 14 IEC 60947-5-4 JIS C8201-1
<b>product certifications</b>	CSA DNV BV LROS (Lloyds register of shipping) UL listed
<b>trilling bestendigheid</b>	5 gn (f= 2...500 Hz) In overeenstemming met IEC 60068-2-6
<b>schokbestendigheid</b>	30 gn (duur = 18 ms) voor halve sinusgolf versnelling In overeenstemming met IEC 60068-2-27 50 gn (duur = 11 ms) voor halve sinusgolf versnelling In overeenstemming met IEC 60068-2-27

## Verpakkingseenheid

<b>Eenheidstype van verpakking 1</b>	PCE
<b>Aantal eenheden in verpakking 1</b>	1
<b>verpakking 1 hoogte</b>	5,900 cm
<b>verpakking 1 breedte</b>	10,100 cm
<b>verpakking 1 lengte</b>	6,100 cm
<b>verpakking_1_gewicht</b>	32,000 g

## contractuele waarborg

<b>Garantie (in maanden)</b>	18
------------------------------	----

Schneider Electric wil tegen 2050 de Net Zero-status hebben bereikt via partnerschappen in de toeleveringsketen, materialen met een lagere impact en circulariteit via onze doorlopende campagne "Use Better, Use Longer, Use Again" om de levensduur van producten en de recycleerbaarheid te verlengen.

[Uitleg van Environmental Data >](#)

[Hoe evalueren we de duurzaamheid van producten? >](#)

### Milieuvoetafdruk

Totale levenscyclus ecologische voetafdruk	0.2 kg CO2 eq.
Koolstofvoetafdruk van de fabricagefase [A1–A3]	0.1 kg CO2 eq.
Koolstofvoetafdruk van de distributiefase [A4]	0 kg CO2 eq.
Koolstofvoetafdruk van de installatiefase [A5]	0 kg CO2 eq.
Koolstofvoetafdruk van de gebruiksfase [B2, B3, B4, B6]	0 kg CO2 eq.
Koolstofvoetafdruk van de einde-levensfase [C1–C4]	0 kg CO2 eq.

## Use Better

### Materialen en verpakking

Gemiddeld percentage gerecycleerde kunststof	28 %
Gemiddeld percentage gerecycleerd metaal	60 %
Pakket met gerecycleerd karton	Ja
Verpakkingen zonder kunststof	Ja
RoHS-richtlijn van de EU	<a href="#">Conform</a>
REACH-verordening	<a href="#">Referentie bevat geen SVHC boven drempelwaarde</a>

## Use Longer

### Levensduurverlenging

Reparatie	Nee
-----------	-----

## Use Again

### Herverpakken en herfabriceren

Circulair Profiel	<a href="#">Informatie over einde levensduur</a>
Terugname	Ja

Dimensions Drawings

Dimensions

---

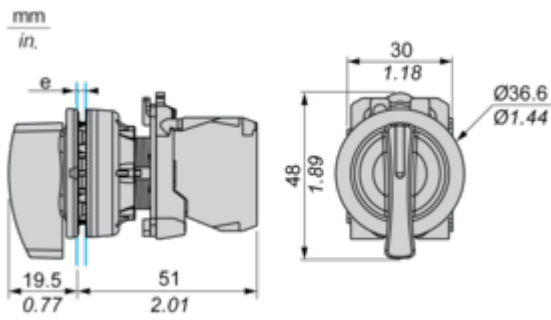

e: Clamping thickness: 1 to 6 mm / 0.04 to 0.24 in.

Mounting and Clearance

Panel Cut-out for Pushbuttons, Switches and Pilot Lights (Finished Holes, Ready for Installation)

---

Connection by Screw Clamp Terminals or Plug-in Connectors



(1) Diameter on finished panel or support

(2)  $\varnothing 30.75 \text{ mm}$  recommended ( $\varnothing 30.5 \text{ mm} \text{ }_0^{+0.5}$ ) /  $\varnothing 1.21 \text{ in.}$  recommended ( $\varnothing 1.20 \text{ in.} \text{ }_0^{+0.0196}$ )

Connections	a in mm	a in in.	b in mm	b in in.
By screw clamp terminals or plug-in connector	40	1.57	40	1.57
By Faston connectors	45	1.77	40	1.57

Technical Description

Electrical Composition Corresponding to Code C3

---



Electrical Composition Corresponding to Code C4

---



Electrical Composition Corresponding to Code C5

---



Electrical Composition Corresponding to Code C6

---



Electrical Composition Corresponding to Code C7

---

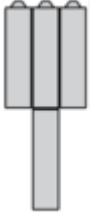

Electrical Composition Corresponding to Code C8

---



Electrical Composition Corresponding to Codes C9, C11, SF1 and SR1

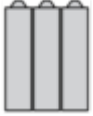

Electrical Composition Corresponding to Code C15

---

1 N/O



1 N/C



1 N/O + N/C or 1 N/O + N/O or 1 N/C + N/C



**Legend**

---

Single contact



Double contact



Light block



Possible location



Sequence of Contacts Fitted to 2-position Selector Switch Body

Position 315°



<b>Push</b>	Position	Top			
		Bottom			
	Location		Left	Centre	Right
	State		0	0	0
	Contacts		N/O	open	open
		N/C	closed	closed	closed

Position 45°





<b>Push</b>	Position	Top			
		Bottom			
	Location		Left	Centre	Right
	State		1	1	1
<b>Contacts</b>	N/O		closed	closed	closed
	N/C		open	open	open

Technical Illustration

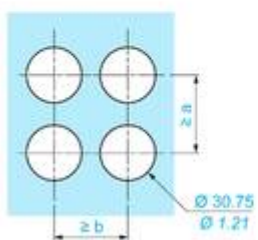
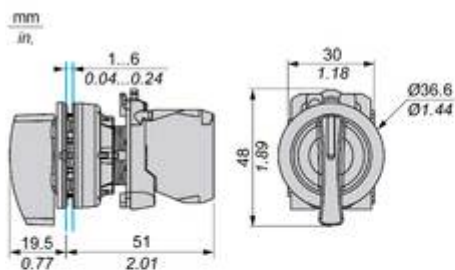
Dimensions



	a (mm)	a (in.)	b (mm)	b (in.)
 ZBE..... ZBV.....	40	1.57	40	1.57
 ZBE.....3 ZBV.....3	45	1.77	40	1.57
 ZBE.....4 ZBV.....4	40	1.57	40	1.57