

Data Sheet | Item Number: 218-518

PCB terminal block; Locking slides; 0.5 mm²; Pin spacing 2.54 mm; 18-pole; CAGE CLAMP®; gray

<https://www.wago.com/218-518>



Color: ■ gray

Similar to illustration

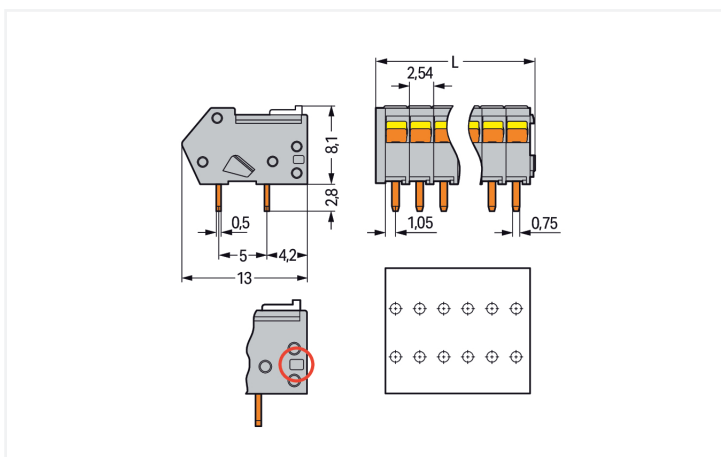
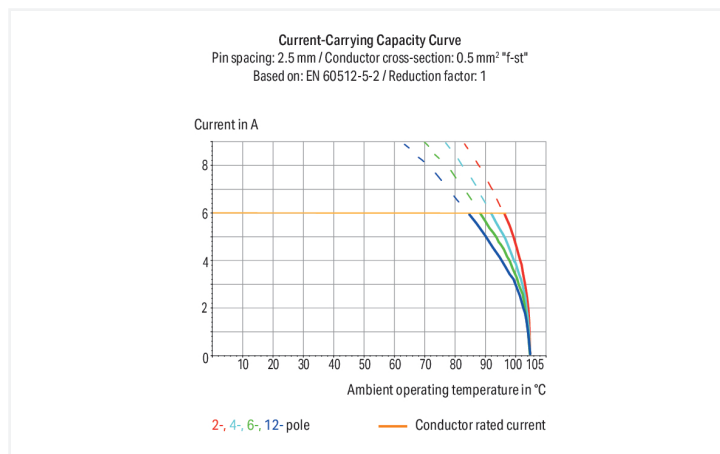

Dimensions in mm

L = (pole no. x pin spacing) + 1.5 mm groove at the back of the terminal strip indicates the 2.54 mm pin spacing (red circle).

PCB terminal block, 218 Series, gray

Connect conductors quickly and safely with this PCB terminal block (item number 218-518). It is a universal connector that can be used almost anywhere, e.g., as a pluggable PCB connector, panel feedthrough header, connector for rail-mount terminal blocks, or a floating connector for different mounting methods. Strip lengths must be between 5 and 6 mm when connecting conductors to this PCB terminal block. This product features one conductor terminal and utilizes CAGE CLAMP®. Our trusted universal connection known as CAGE CLAMP® leads the way when it comes to connection technology and electrical interconnections. The item's dimensions are (47.22 x 10.9 x 13) mm (width x height x depth). This PCB terminal block is suitable for conductor cross sections ranging from 0.08 mm² to 0.5 mm². The contact surface is coated with tin. A slider is used to operate this PCB terminal block. THT is used to assemble the PCB terminal block. Insert the conductor into the board at an angle of 40°..

Notes

Variants:	Other pole numbers Other colors Mixed-color PCB connector strips Direct marking Other versions (or variants) can be requested from WAGO Sales or configured at https://configurator.wago.com/ .
-----------	--

Electrical data

Ratings per	IEC/EN 60664-1			Approvals per	UL 1059		
Overvoltage category	III	III	II	Use group	B	C	D
Pollution degree	3	2	2	Rated voltage	150 V	-	-
Nominal voltage	80 V	160 V	320 V	Rated current	4 A	-	-
Rated impulse withstand voltage	2.5 kV	2.5 kV	2.5 kV				
Rated current	6 A	6 A	6 A				

Approvals per	CSA		
Use group	B	C	D
Rated voltage	150 V	-	-
Rated current	4 A	-	-

Connection Data

Clamping units	18	Connection 1	
Total number of potentials	18	Connection technology	CAGE CLAMP®
Number of connection types	1	Actuation type	Slider
Number of levels	1	Solid conductor	0.08 ... 0.5 mm ² / 28 ... 20 AWG
		Fine-stranded conductor	0.08 ... 0.5 mm ² / 28 ... 20 AWG
		Fine-stranded conductor; with insulated ferrule	0.25 mm ²
		Fine-stranded conductor; with uninsulated ferrule	0.25 mm ²
		Note (conductor cross-section)	Terminating 0.75 mm ² /18 AWG conductors is possible; however insulation diameter allows only every other clamping unit to be terminated with this conductor size.
		Strip length	5 ... 6 mm / 0.2 ... 0.24 inches
		Conductor connection direction to PCB	40 °
		Pole number	18

Physical data

Pin spacing	2.54 mm / 0.1 inches
Width	47.22 mm / 1.859 inches
Height	10.9 mm / 0.429 inches
Height from the surface	8.1 mm / 0.319 inches
Depth	13 mm / 0.512 inches
Solder pin length	2.8 mm
Solder pin dimensions	0.5 x 0.75 mm
!	1.1 ^(±0.1) mm

PCB contact

PCB contact	THT
Solder pin arrangement	over the entire terminal strip (in-line)
Number of solder pins per potential	2

Material data

Note (material data)	Information on material specifications can be found here
Color	gray
Material group	I
Insulation material (main housing)	Polyamide (PA66)
Flammability class per UL94	V0
Clamping spring material	Chrome-nickel spring steel (CrNi)
Contact material	Electrolytic copper (E _{cu})
Contact Plating	Tin
Fire load	0.309 MJ
Weight	5.9 g

Environmental requirements

Limit temperature range	-60 ... +105 °C
-------------------------	-----------------

Commercial data

Product Group	4 (Printed Circuit Connectors)
PU (SPU)	100 (25) pcs
Packaging type	Box
Country of origin	PL
GTIN	4044918878708
Customs tariff number	85369010000

Product Classification

UNSPSC	39121409
eCl@ss 10.0	27-44-04-01
eCl@ss 9.0	27-44-04-01
ETIM 9.0	EC002643
ETIM 10.0	EC002643
ECCN	NO US CLASSIFICATION

Environmental Product Compliance

RoHS Compliance Status	Compliant, No Exemption
------------------------	-------------------------

Approvals / Certificates

General approvals



Approval	Standard	Certificate Name
CCA DEKRA Certification B.V.	EN 60947	NTR NL-7076
CCA DEKRA Certification B.V.	EN 60947-7-4	NTR NL-7785
CCA DEKRA Certification B.V.	EN 60947-7-4	77-111038

General approvals

CSA DEKRA Certification B.V.	C22.2 No. 158	1565656
ENEC DEKRA Certification B.V.	EN 60947	2160584.01
UL UL International Germany GmbH	UL 1059	E45172

Declarations of conformity and manufacturer's declarations

Approval	Standard	Certificate Name
EU-Declaration of Confor- mity WAGO GmbH & Co. KG	-	-
UK-Declaration of Confor- mity WAGO GmbH & Co. KG	-	-

Downloads

Environmental Product Compliance



Compliance Search
Environmental Product Compliance 218-518 

Documentation

Additional Information
Technical Section 03.04.2019 pdf 2027.26 KB 

CAD/CAE-Data

CAD data
2D/3D Models 218-518 

CAE data
EPLAN Data Portal 218-518 
ZUKEN Portal 218-518 

PCB Design

Symbol and Footprint via SamacSys 218-518 
Symbol and Footprint via Ultra Librarian 218-518 

1 Compatible Products

1.1 Optional Accessories

1.1.1 Ferrule

1.1.1.1 Ferrule



Item No.: 216-301

Ferrule; Sleeve for 0.25 mm² / AWG 24; insulated; electro-tin plated; yellow

Item No.: 216-321

Ferrule; Sleeve for 0.25 mm² / AWG 24; insulated; electro-tin plated; yellow

Item No.: 216-151

Ferrule; Sleeve for 0.25 mm² / AWG 24; uninsulated; electro-tin plated

Item No.: 216-131

Ferrule; Sleeve for 0.25 mm² / AWG 24; uninsulated; electro-tin plated; silver-colored

1.1.2 Marking

1.1.2.1 Marking strip



Item No.: 210-331/254-202

Marking strips; as a DIN A4 sheet; MARKED; 1-16 (400x); Height of marker strip: 2.3 mm/0.091 in; Strip length 182 mm; Horizontal marking; Self-adhesive; white

Item No.: 210-331/254-207

Marking strips; as a DIN A4 sheet; MARKED; 1-48 (100x); Height of marker strip: 2.3 mm/0.091 in; Strip length 182 mm; Horizontal marking; Self-adhesive; white

Item No.: 210-331/254-204

Marking strips; as a DIN A4 sheet; MARKED; 17-32 (400x); Height of marker strip: 2.3 mm/0.091 in; Strip length 182 mm; Horizontal marking; Self-adhesive; white

Item No.: 210-331/254-206

Marking strips; as a DIN A4 sheet; MARKED; 33-48 (400x); Height of marker strip: 2.3 mm/0.091 in; Strip length 182 mm; Horizontal marking; Self-adhesive; white

1.1.3 Test and measurement

1.1.3.1 Testing accessories



Item No.: 735-500

WAGO Test pin; 1 mm Ø; 30 V AC / 60 V DC; CAT0; 1 A; 6 mm uninsulated; Test lead for soldering up to 0,5mm²

1.1.4 Tool

1.1.4.1 Operating tool



Item No.: 210-719

Operating tool; Blade: 2.5 x 0.4 mm; with a partially insulated shaft

Item No.: 210-648

Operating tool; Blade: 2.5 x 0.4 mm; with a partially insulated shaft; angled; short

Installation Notes

Conductor termination



Terminating stranded conductors in confined spaces requires a great deal of patience, unless you use the new 218 Series PCB Terminal Strips. The clamping units of these strips can be held open during termination process via integrated locking slide.

Terminating 0.75 mm²/18 AWG conductors is possible; however insulation diameter allows only every other clamping unit to be terminated with this conductor size.

Conductor termination: To momentarily open the clamping unit, use screwdriver and then insert a stripped conductor. To open clamping unit for an extended period, move locking slide toward conductor entry hole. Then fully insert stripped conductor and move locking slide back to original position (also possible to perform with fingernail).

Incorrect – do not operate the locking slides from the back.

Marking



Labeling with self-adhesive marking strips.

Labeling via factory direct marking.

Testing



Testing directly on the clamping spring.