

TARA Three-hole basin mixer with pop-up waste - Brushed Durabronze (23kt Gold)















TARA

20 710 882 Product version from 6/30/2009 to 6/25/2021



- 135mm projection
- pivotable spout 360°
- circular, air-enriched flow
- height of mixer 270 mm
- height up to aerator 161 mm
- hole diameter valve 32 mm
- hole diameter spout 35 mm
- rosette Ø 55 mm
- 2x screw-in M 10 x 1 pressure hose, leak-tested
- max. flow 7 l/min
- lead-free
- WRAS
- This product can help a building meet the requirements of Green Building Rating Systems, e.g. LEED®, BREEAM®, DGNB

Only suitable for basins with an overflow.

	Brushed Durabronze (23kt Gold)	20 710 882-28
	Chrome	20 710 882-00
	Brushed Platinum	20 710 882-06
	Platinum	20 710 882-08
	Dark Chrome	20 710 882-19
	Matte Black	20 710 882-33
	Brushed Gold (PVD)	20 710 882-37
	Brushed Dark Brass (PVD)	20 710 882-39
	Brushed Bronze (PVD)	20 710 882-42
	Brushed Dark Bronze (PVD)	20 710 882-43
	Brushed Champagne (22kt Gold)	20 710 882-46
	Champagne (22kt Gold)	20 710 882-47
	Brushed Chrome	20 710 882-93
	Brushed Dark Platinum	20 710 882-99

Recommended miscellaneous



High pressure hoses - 12 506 970 90
 • 2x 3/8" x 1/2" x 500mm high pressure hose

TARA Three-hole basin mixer with pop-up waste - Brushed Durabross (23kt Gold)

TARA

20 710 882 Product version from 6/30/2009 to 6/25/2021
mm [inches]

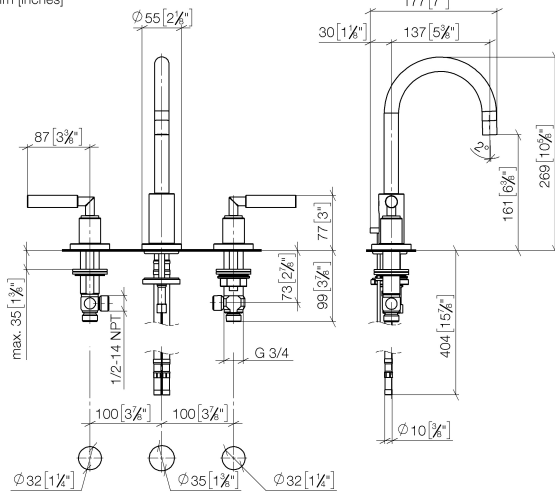

Flow rate chart

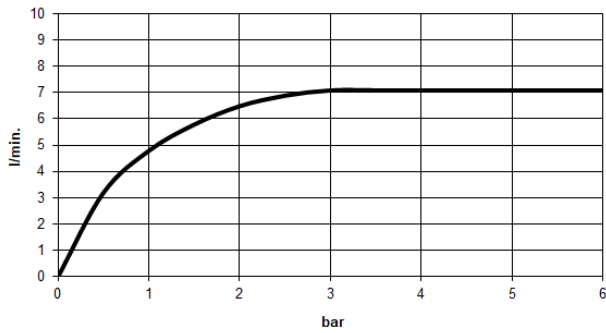

Codes & Standards

DIN 4109	EN 200	Executive Order no. 1007	ISO 3822
Scottish Water Byelaws	UK Water Supply Regulations	Ü-Zeichen	VA-Zeichen
XP P 41-280			



TARA Three-hole basin mixer with pop-up waste - Brushed Durabross (23kt Gold)

TARA

20 710 882 Product version from 6/30/2009 to 6/25/2021

Certificates and sustainability

LGA_18

ETA_18

WRAS_2212

ACS_20 ACC LY

GDV_0400

EPD-DOR-20230287

-IBA1-EN

Environmental.prod

uct-declarat

20 710 882 Product version from 6/30/2009 to 6/25/2021

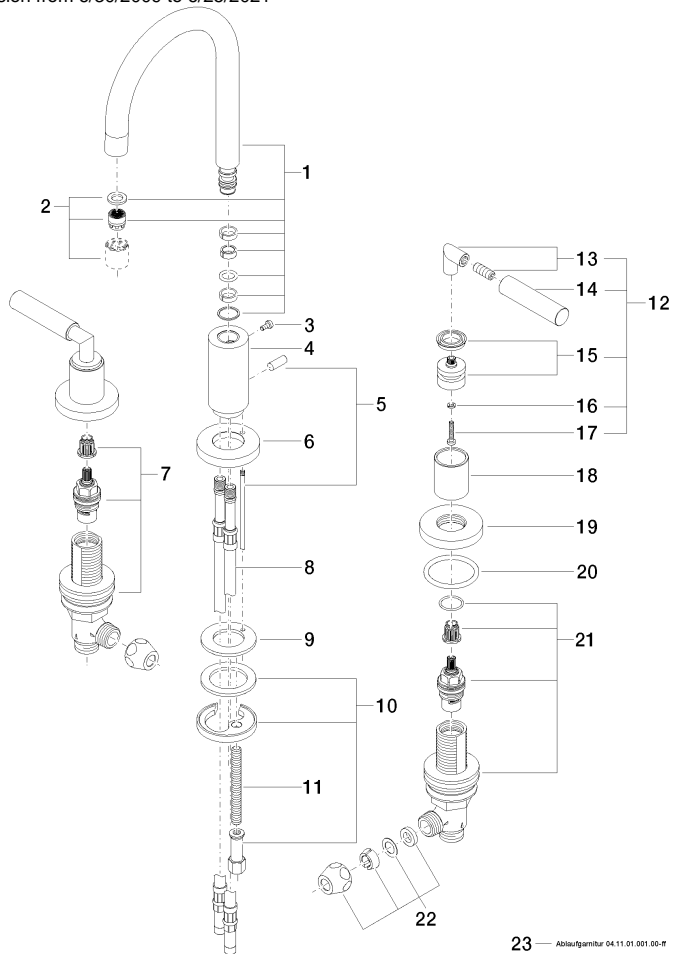

23 — Ablaufsperrtur 04.11.01.001.00-m