

## Data Sheet | Item Number: 226-111

Feedthrough terminal block; Conductor/solder/crimp quick disconnect terminal;  
Plate thickness: 2.5 mm; 4 mm<sup>2</sup>; Pin spacing 6 mm; 1-pole; CAGE CLAMP®; 4,00 mm<sup>2</sup>; gray

<https://www.wago.com/226-111>



Color: ■ gray

Similar to illustration

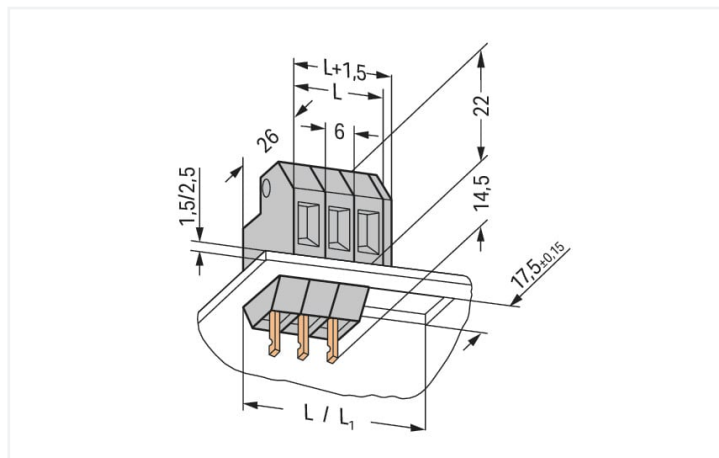

Dimensions in mm

L = pole no. x 6 mm

L1 = L + 1.5 mm

- Modular through terminal blocks with screwdriver-actuated CAGE CLAMP®
- Tool-free insertion into sheet metal cutout
- Conductor entry parallel to enclosure wall saves space

### Electrical data

Ratings	Solder connection		
	IEC/EN 60664-1	IEC/EN 60664-1	IEC/EN 60664-1
Ratings per			
Overvoltage category	III	III	II
Pollution degree	3	2	2
Nominal voltage	320 V	320 V	630 V
Rated surge voltage	4 kV	4 kV	4 kV
Rated current	20 A	20 A	20 A

Ratings	Quick connect contact		
	IEC/EN 60664-1	IEC/EN 60664-1	IEC/EN 60664-1
Ratings per			
Overvoltage category	III	III	II
Pollution degree	3	2	2
Nominal voltage	320 V	320 V	630 V
Rated surge voltage	4 kV	4 kV	4 kV
Rated current	6 A	6 A	6 A

Approvals per	UL 1059		
Use group	B	C	D
Rated voltage	300 V	300 V	600 V
Rated current	6 A	6 A	5 A

Approvals per	CSA		
Use group	B	C	D
Rated voltage	300 V	300 V	600 V
Rated current	6 A	6 A	5 A

### Connection data

Connection points	1
Total number of potentials	1
Number of connection types	2
Number of levels	1

Connection 1	
Connection technology	CAGE CLAMP®
Number of connection points	1
Actuation type	Operating tool
Solid conductor	0.08 ... 4 mm <sup>2</sup> / 28 ... 12 AWG
Fine-stranded conductor	0.08 ... 4 mm <sup>2</sup> / 28 ... 12 AWG
Fine-stranded conductor; with insulated ferrule	0.25 ... 2.5 mm <sup>2</sup>
Fine-stranded conductor; with uninsulated ferrule	0.25 ... 2.5 mm <sup>2</sup>
Strip length	9 ... 10 mm / 0.35 ... 0.39 inches
Pole number	1

### Connection 2

Connection technology 2	Solder connection
Number of connection points 2	1

### Connection 3

Connection technology 3	Quick-connect contact
-------------------------	-----------------------

### Physical data

Pin spacing	6 mm / 0.236 inches
Width	6 mm / 0.236 inches
Height	36.5 mm / 1.437 inches
Height from the surface	22 mm / 0.866 inches
Depth	26 mm / 1.024 inches
Solder pin dimensions	2.8 x 0.8 mm

### Mechanical data

Housing sheet thickness	2.5 ... 2.5 mm / 0.098 ... 0.098 inches
Mounting type	Snap-in foot Feed-through mounting

### Material data

Note (material data)	<a href="https://www.wago.com/us/material-specifications">Information on material specifications can be found here</a>
Color	gray
Material group	I
Insulation material	Polyamide (PA66)
Flammability class per UL94	V0
Clamping spring material	Chrome-nickel spring steel (CrNi)
Contact material	Electrolytic copper (E <sub>CU</sub> )
Contact plating	Tin
Fire load	0.12 MJ
Weight	3.4 g

### Environmental requirements

Limit temperature range	-60 ... +105 °C
-------------------------	-----------------

### Commercial data

Product Group	4 (Printed Circuit Connectors)
eCl@ss 10.0	27-14-11-34
eCl@ss 9.0	27-14-11-34
ETIM 8.0	EC001283
ETIM 7.0	EC001283
PU (SPU)	200 pcs
Packaging type	Bag
Country of origin	DE
GTIN	4044918794428
Customs tariff number	85369010000

Environmental Product Compliance	
RoHS Compliance Status	Compliant, No Exemption

### Approvals / Certificates

General approvals			Approvals for marine applications		
Approval	Standard	Certificate Name	Approval	Standard	Certificate Name
CSA DEKRA Certification B.V.	C22.2	70010891	BV Bureau Veritas S.A.	EN 60947	07436/F0 BV
UL UL International Germany GmbH	UL 1059	E45172			

### Downloads

Environmental Product Compliance	
Compliance Search	
Environmental Product Compliance 226-111	<a href="#">↓</a>

### Documentation

Additional Information			
Technical Section	03.04.2019	pdf 2010.85 KB	<a href="#">↓</a>

### CAD/CAE-Data

CAE data	
EPLAN Data Portal 226-111	<a href="#">↓</a>
WSCAD Universe 226-111	<a href="#">↓</a>

## 1 Compatible Products

### 1.1 Required Accessories

#### 1.1.1 End plate

##### 1.1.1.1 End plate



**Item No.: 226-120**

End plate; for 400 V, cut-out dimensions L1; 1.5 mm thick; gray

**Item No.: 226-110**

End plate; for 630 V, cut-out dimensions L1; 1.5 mm thick; gray

### 1.1.2 Installation

#### 1.1.2.1 Intermediate plate



**Item No.: 226-109**

Spacer; for plate thickness 1.5 mm; 6 mm wide; gray

**Item No.: 226-119**

Spacer; for plate thickness 2.5 mm; 6 mm wide; gray

## 1.2 Optional Accessories

### 1.2.1 Ferrule

#### 1.2.1.1 Ferrule



**Item No.: 216-241**

Ferrule; Sleeve for 0.5 mm<sup>2</sup> / 20 AWG; insulated; electro-tin plated; electrolytic copper; gastight crimped; acc. to DIN 46228, Part 4/09.90; white



**Item No.: 216-141**

Ferrule; Sleeve for 0.5 mm<sup>2</sup> / 20 AWG; un-insulated; electro-tin plated; electrolytic copper; gastight crimped; acc. to DIN 46228, Part 1/08.92



**Item No.: 216-242**

Ferrule; Sleeve for 0.75 mm<sup>2</sup> / 18 AWG; insulated; electro-tin plated; electrolytic copper; gastight crimped; acc. to DIN 46228, Part 4/09.90; gray



**Item No.: 216-262**

Ferrule; Sleeve for 0.75 mm<sup>2</sup> / 18 AWG; insulated; electro-tin plated; electrolytic copper; gastight crimped; acc. to DIN 46228, Part 4/09.90; gray



**Item No.: 216-142**

Ferrule; Sleeve for 0.75 mm<sup>2</sup> / 18 AWG; un-insulated; electro-tin plated; electrolytic copper; gastight crimped; acc. to DIN 46228, Part 1/08.92



**Item No.: 216-243**

Ferrule; Sleeve for 1 mm<sup>2</sup> / AWG 18; insulated; electro-tin plated; electrolytic copper; gastight crimped; acc. to DIN 46228, Part 4/09.90; red



**Item No.: 216-263**

Ferrule; Sleeve for 1 mm<sup>2</sup> / AWG 18; insulated; electro-tin plated; electrolytic copper; gastight crimped; acc. to DIN 46228, Part 4/09.90; red



**Item No.: 216-143**

Ferrule; Sleeve for 1 mm<sup>2</sup> / AWG 18; un-insulated; electro-tin plated; electrolytic copper; gastight crimped; acc. to DIN 46228, Part 1/08.92



**Item No.: 216-244**

Ferrule; Sleeve for 1.5 mm<sup>2</sup> / AWG 16; insulated; electro-tin plated; electrolytic copper; gastight crimped; acc. to DIN 46228, Part 4/09.90; black



**Item No.: 216-264**

Ferrule; Sleeve for 1.5 mm<sup>2</sup> / AWG 16; insulated; electro-tin plated; electrolytic copper; gastight crimped; acc. to DIN 46228, Part 4/09.90; black



**Item No.: 216-284**

Ferrule; Sleeve for 1.5 mm<sup>2</sup> / AWG 16; insulated; electro-tin plated; electrolytic copper; gastight crimped; acc. to DIN 46228, Part 4/09.90; black



**Item No.: 216-144**

Ferrule; Sleeve for 1.5 mm<sup>2</sup> / AWG 16; un-insulated; electro-tin plated; electrolytic copper; gastight crimped; acc. to DIN 46228, Part 1/08.92; silver-colored



**Item No.: 216-246**

Ferrule; Sleeve for 2.5 mm<sup>2</sup> / AWG 14; insulated; electro-tin plated; electrolytic copper; gastight crimped; acc. to DIN 46228, Part 4/09.90; blue



**Item No.: 216-266**

Ferrule; Sleeve for 2.5 mm<sup>2</sup> / AWG 14; insulated; electro-tin plated; electrolytic copper; gastight crimped; acc. to DIN 46228, Part 4/09.90; blue



**Item No.: 216-286**

Ferrule; Sleeve for 2.5 mm<sup>2</sup> / AWG 14; insulated; electro-tin plated; electrolytic copper; gastight crimped; acc. to DIN 46228, Part 4/09.90; blue



**Item No.: 216-106**

Ferrule; Sleeve for 2.5 mm<sup>2</sup> / AWG 14; un-insulated; electro-tin plated; silver-colored

## 1.2.2 Test and measurement

### 1.2.2.1 Testing accessories



**Item No.: 210-136**

Test plug; 2 mm Ø; with 500 mm cable; red

## 1.2.3 Tool

### 1.2.3.1 Operating tool



**Item No.: 210-720**

Operating tool; Blade: 3.5 x 0.5 mm; with a partially insulated shaft; multicoloured



**Item No.: 210-657**

Operating tool; Blade: 3.5 x 0.5 mm; with a partially insulated shaft; short; multicoloured

## Installation Notes

### Installation

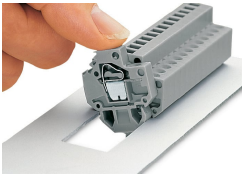

Snapping a feedthrough terminal block (226 Series) into the cutout.

## Testing

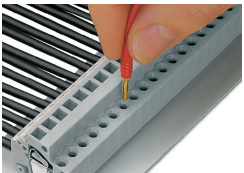

Testing with 2 mm Ø test plug – touch contact.