

TRONIX

guided by light



Ceiling light 15W 136-045
with emergency kit 136-046

Introduction



This ceiling light is with highly performance, such as on/off, Dimmable, Emergency, color switchable; Quick terminal block and rotation cover design makes the fitting much easier to install; IP65 Driver can be replaced easily.

Features

1. Multifunctional: on/off, Emergency, Color switchable.
2. Labor-saver: easy to install and maintain.
3. Long lifetime: 50,000hrs.

Application Areas

It is designed for general lighting applications. It is also widely used for public areas, such as stairway, lobby, reception, corridors etc.



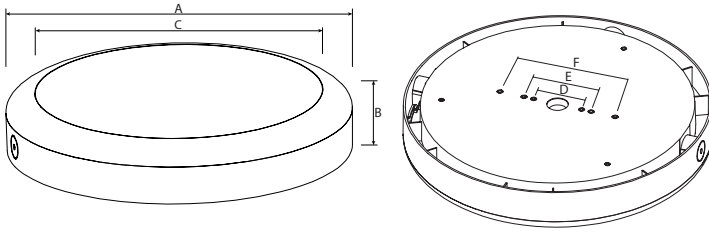

Measurement

Inch	Dimension(mm)						Size(mm)	Product Weight (Kg)		Package weight (Kg)		Carton Size(cm)	Qty/CTN
	A	B	C	D	E	F		N.W/PC	G.W/PC	N.W/CTN	G.W/CTN		
12"	300	60	249.5	50	70	120	Ø300*60	1.15	1.27	6.95	7.65	41*33*33.5	6

Technical Data Sheet

Model No.			136-045	136-046
Watt(W)			15W	
Dimension(mm)			Ø300*60	
Rated Input Voltage(V)			AC230V	
Input Voltage(V)			AC200-240V	
LED			SMD	
SDCM			<6	
CCT(K)			Tri-White : 3000K / 4000K / 5700K	
"Luminous Flux (lm) ±5%	3-CCT	DIM	1270-1420	
			-	
CRI			≥80	
Beam Angle (°)			110°	
LED Driver			Built-in	
DIM			NO	
Emergency Kits			NO	YES
Protection Class			Class II	
IP Rating			IP65	
IK Rating			IK08	
Finishing color			White RAL 9016	
Material			PC	
Lifetime (hr)			50,000h	
Glow wire test (°C)			750°	
Operating Temp.(°C)			-20° ~45°	
Storage Temp.(°C)			-20° ~65°	
Installation			Surface Mounted	

Driver Datasheet

Power	15W
Rated Input Voltage(V)	AC230V
Frequency	50/60Hz
Input Voltage	AC200-240V
Efficiency	≥85%
Total load wattage	15W±1W
Power Factor	0.9
Rated Input Current	≤0.1A
Full load output voltage	DC25-42V
Rated output current	350mA
Output current range	350mA±5%
Power tolerance	±5%
Current output tolerance	±5%
Short circuit protection	PASS
Over voltage protection	PASS
Over temperature protection	PASS
THD	≤18%
Surge	L-N 500V
Withstand voltage	AC3750V

Driver Datasheet (Emergency)

Power	4W
Rated Input Voltage(V)	AC230V
Frequency	50/60Hz
Input Voltage	AC200-240V
Efficiency	70%
Total load wattage	4W±1W
Rated Input Current	≤0.05A
Full load output voltage	DC25-40V
Rated output current	70mA
Output current range	70mA ±5%
Power tolerance	±5%
Current output tolerance	±5%
Battery duration	>3h
Charge Period	<24h
Short circuit protection	PASS
Over voltage protection	PASS
Over temperature protection	PASS

Installation Procedure

WARNING

1. Switch off before installation.
2. Switch on only after complete installation and examination of the circuit.
3. Professional electrician for installation and maintenance only.

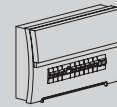

Turn Off power supply before starting any installation. Read instructions & check you have all the tools & accessories to complete the installation correctly.

How to install

Step 1

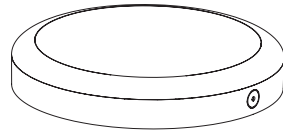

Take out the lamp and accessory pack.

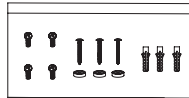

Step 2

Unscrew the front frame anticlockwise and take it out, make the frame, diffuser and back housing separately.

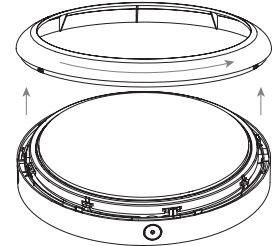

Step 3

Disconnect the connection plug, fix the base plate (Installation holes are optional according to different market requests).

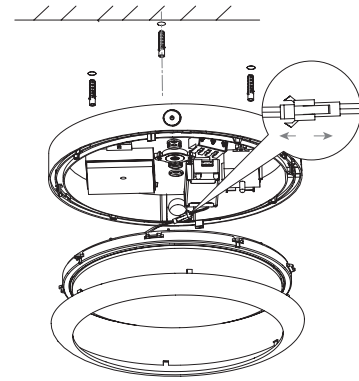
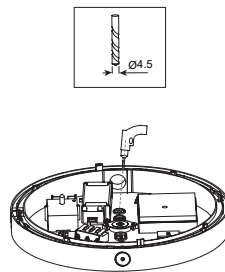

Step 4

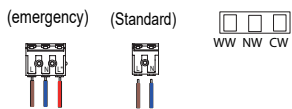

set the connectors well and insert the diffuser cover on the back housing (if with IP65, screws need to be inserted)

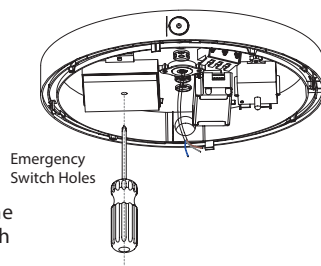

Step 5

Match the frame to the plate and push into the slot.

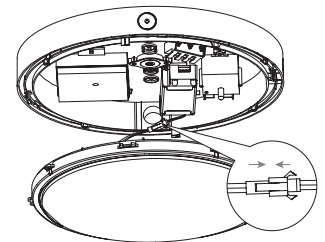
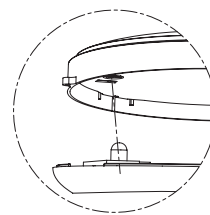
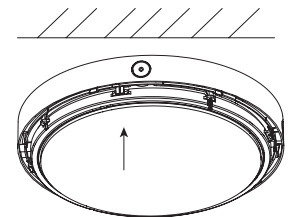

Step 6

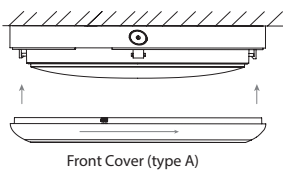

Front Cover (type A)

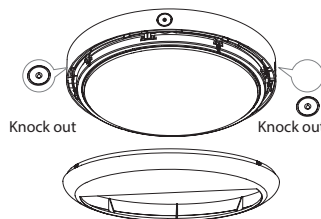

Knock out Knock out

Front Cover (type B)

Match the cover with plate (If with Type B cover, make sure the center line is on the connecting line of the two knock out)

Step 7

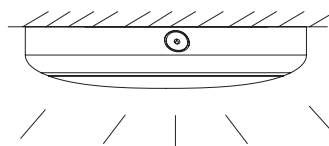

Installation of concealed wiring.

