

## Data Sheet | Item Number: 2006-1631

2-conductor fuse terminal block; with pivoting fuse holder; for glass cartridge fuse 1/4" x 1 1/4"; without blown fuse indication; for DIN-rail 35 x 15 and 35 x 7.5; 6 mm<sup>2</sup>; Push-in CAGE CLAMP®; gray

<https://www.wago.com/2006-1631>

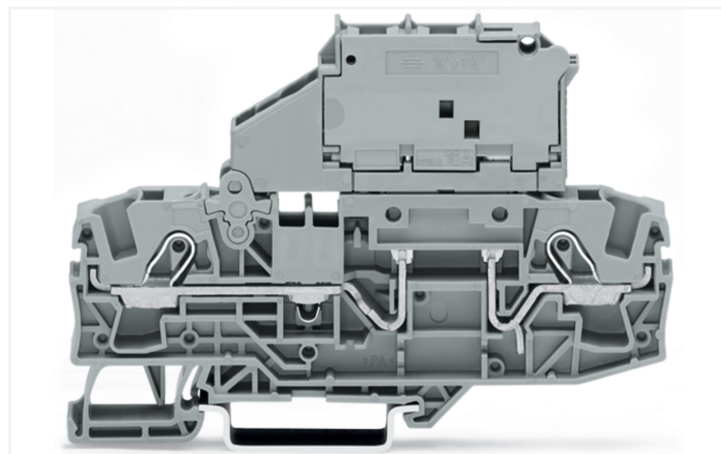
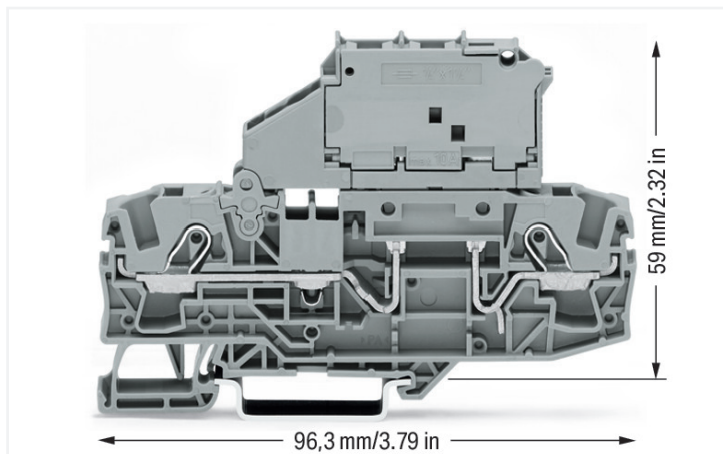

Color: ■ gray

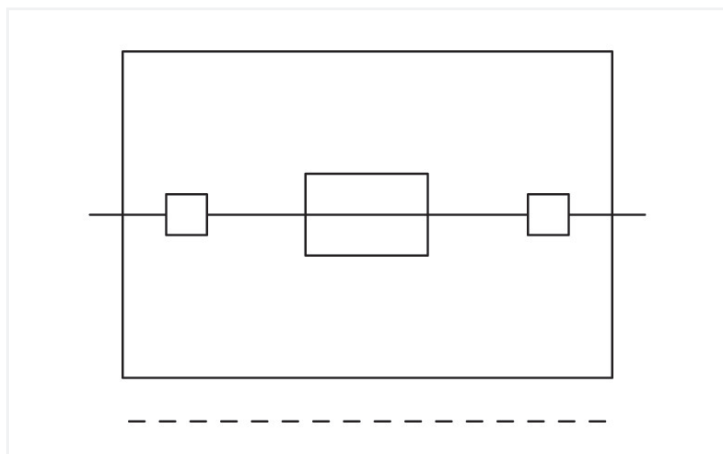

### Fuse terminal block, 2006 Series, operating tool

Easily, quickly and safely connect conductors with this fuse terminal block (item number 2006-1631). Conductors can only be connected to this fuse terminal block if their strip length is between 13 and 15 mm. Featuring conductor terminals along with Push-in CAGE CLAMP®, this connector outperforms the competition. Push-in CAGE CLAMP® connection technology is ideal for connecting all conductor types. Both solid and fine-stranded conductors with ferrules can be inserted without the need for tools—all thanks to its pluggable design. Depending on the conductor type, this fuse terminal block is suitable for conductor cross sections ranging from 0.5 mm<sup>2</sup> to 10 mm<sup>2</sup>.

### Notes

Safety Information

The 2 mm test slot is only approved for high impedance measurement up to max. 100 mA.

## Electrical data

| Ratings per                     | IEC/EN 60947-7-3 |     |    |
|---------------------------------|------------------|-----|----|
| Overvoltage category            | III              | III | II |
| Pollution degree                | 3                | 2   | 2  |
| Nominal voltage                 | 800 V            | -   | -  |
| Rated impulse withstand voltage | 8 kV             | -   | -  |
| Rated current                   | 10 A             | -   | -  |

| Ratings per IEC/EN – Notes |   |
|----------------------------|---|
| Ratings (note)             | Electrical ratings are given by the fuse. |

| Approvals per | UL 1059 |       |   |
|---------------|---------|-------|---|
| Use group     | B       | C     | D |
| Rated voltage | 600 V   | 600 V | - |
| Rated current | 15 A    | 15 A  | - |

| Approvals per | CSA 22.2 No 158 |       |   |
|---------------|-----------------|-------|---|
| Use group     | B               | C     | D |
| Rated voltage | 600 V           | 600 V | - |
| Rated current | 15 A            | 15 A  | - |

## Power Loss

|                                       |  |
|---------------------------------------|--|
| Power loss (max.) $P_{I(max)}$ (note) | When selecting glass cartridge fuses, make sure that the maximum power loss listed below is not exceeded. The power loss is determined according to IEC or EN 60947-7-3/VDE 0611-6 at 23°C. The temperature rise of the terminal block must be checked according to their application and mounting. Higher ambient temperatures represent an additional impact on miniature fuses. Therefore, in such applications, the rated current must be reduced if necessary. More details are available from the manufacturers. |
|---------------------------------------|--|

Maximum power loss  $P_{loss}$  of fuse insert for overload and short-circuit protection (individual arrangement) 1.6 W

Maximum power loss  $P_{loss}$  of fuse insert for overload and short-circuit protection (block arrangement) 1.6 W

Power loss  $P_I$  max. short-circuit protection (individual arrangement) 2.5 W

Power loss  $P_{loss}$  (max.) of fuse cartridge for short-circuit protection (block arrangement) 2.5 W

## General information

|                  |                            |
|------------------|----------------------------|
| Fuse receptacle  | pivoting                   |
| Fuse type        | Cylindrical fuse; ¼" x 1¼" |
| Wiring direction | Front-entry wiring         |

## Connection Data

|                            |   |
|----------------------------|---|
| Clamping units             | 2 |
| Total number of potentials | 1 |
| Number of levels           | 1 |
| Number of jumper slots     | 2 |

## Connection 1

|  |   |
|--|---|
| Connection technology                                      | Push-in CAGE CLAMP®   |
| Actuation type   | Operating tool  |
| Connectable conductor materials                            | Copper  |
| Nominal cross-section                                      | 6 mm <sup>2</sup>   |
| Solid conductor  | 0.5 ... 10 mm <sup>2</sup> / 20 ... 8 AWG   |
| Solid conductor; push-in termination                       | 1 ... 10 mm <sup>2</sup> / 14 ... 8 AWG   |
| Fine-stranded conductor                                    | 0.5 ... 10 mm <sup>2</sup> / 20 ... 8 AWG   |
| Fine-stranded conductor; with insulated ferrule            | 0.5 ... 6 mm <sup>2</sup> / 20 ... 10 AWG   |
| Fine-stranded conductor; with ferrule; push-in termination | 2.5 ... 6 mm <sup>2</sup> / 16 ... 10 AWG   |
| Note (conductor cross-section)                             | Depending on the conductor characteristic, a conductor with a smaller cross-section can also be inserted via push-in termination. |
| Strip length   | 13 ... 15 mm / 0.51 ... 0.59 inches   |
| Wiring direction   | Front-entry wiring  |

### Physical data

|                                   |                        |
|-----------------------------------|------------------------|
| Width                             | 7.5 mm / 0.295 inches  |
| Height                            | 96.3 mm / 3.791 inches |
| Depth from upper-edge of DIN-rail | 59 mm / 2.323 inches   |

### Mechanical data

|               |                     |
|---------------|---------------------|
| Mounting type | DIN-35 rail         |
| Marking level | Center/side marking |

### Material data

|                                    |  |
|------------------------------------|--|
| Note (material data)               | <a href="#">Information on material specifications can be found here</a> |
| Color                              | gray   |
| Material group                     | I  |
| Insulation material (main housing) | Polyamide (PA66)   |
| Flammability class per UL94        | V0   |
| Fire load                          | 0.456 MJ   |
| Weight                             | 24.6 g   |

### Environmental requirements

|                                  |                 |
|----------------------------------|-----------------|
| Processing temperature           | -35 ... +85 °C  |
| Continuous operating temperature | -60 ... +105 °C |

### Environmental Testing

|   |   |
|---|---|
| Test specification:<br>Railway applications –<br>Rolling stock –<br>Electronic equipment            | DIN EN 50155 (VDE 0115-200):2022-06                 |
| Test procedure:<br>Railway applications –<br>Rolling stock equipment –<br>Vibration and shock tests | DIN EN 61373 (VDE 0115-0106):2011-04                |
| Spectrum/Mounting location  | Service life test, Category 1, Class A/B            |
| Functional test with noise-like oscillations  | Test passed according to Section 8 of the standard  |
| Frequency   | $f_1 = 5 \text{ Hz}$ to $f_2 = 150 \text{ Hz}$      |
| Acceleration  | 0.101g (highest test level used for all axes)       |
| Test duration per axis  | 10 min.   |
| Test directions   | X, Y and Z axes                                     |
| Monitoring of contact faults and interruptions  | Passed  |
| Voltage drop measurement before and after each axis   | Passed  |
| Simulated service life test through increased levels of noise-like oscillations                     | Test passed according to Section 9 of the standard  |
| Frequency   | $f_1 = 5 \text{ Hz}$ to $f_2 = 150 \text{ Hz}$      |
| Acceleration  | 0.572g (highest test level used for all axes)       |
| Test duration per axis  | 5 h   |
| Test directions   | X, Y and Z axes                                     |
| Extended testing: Monitoring of contact faults and interruptions                                    | Passed  |
| Extended testing: Voltage drop measurement before and after each axis                               | Passed  |
| Shock test  | Test passed according to Section 10 of the standard |
| Shock pulse form  | Half sine   |
| Acceleration  | 5g (highest test level used for all axes)           |
| Shock duration  | 30 ms   |
| Number of shocks (per axis)   | 3 pos. und 3 neg.                                   |
| Test directions   | X, Y and Z axes                                     |

### Environmental Testing

|   |        |
|---|--------|
| Extended testing: Monitoring of contact faults and interruptions      | Passed |
| Extended testing: Voltage drop measurement before and after each axis | Passed |
| Vibration and shock stress for rolling stock equipment                | Passed |

### Commercial data

|                       |               |
|-----------------------|---------------|
| Product Group         | 22 (TOPJOB S) |
| PU (SPU)              | 25 pcs        |
| Packaging type        | Box           |
| Country of origin     | CN            |
| GTIN                  | 4045454821180 |
| Customs tariff number | 85369095000   |

### Product Classification

|             |                      |
|-------------|----------------------|
| UNSPSC      | 39121410             |
| eCl@ss 10.0 | 27-14-11-16          |
| eCl@ss 9.0  | 27-14-11-16          |
| ETIM 9.0    | EC000899             |
| ETIM 10.0   | EC000899             |
| ECCN        | NO US CLASSIFICATION |

### Environmental Product Compliance

|                        |                         |
|------------------------|-------------------------|
| RoHS Compliance Status | Compliant, No Exemption |
|------------------------|-------------------------|

### Approvals / Certificates

#### General approvals



| Approval                             | Standard      | Certificate Name |
|--------------------------------------|---------------|------------------|
| CCA<br>DEKRA Certification B.V.      | IEC 60947     | 71-122840 REV.1  |
| CCA<br>DEKRA Certification B.V.      | EN 60947      | NTR NL-8060      |
| CSA<br>CSA Group                     | C22.2 No. 158 | 1543858          |
| UR<br>Underwriters Laboratories Inc. | UL 1059       | E45172           |

#### Declarations of conformity and manufacturer's declarations



| Approval   | Standard | Certificate Name |
|--|----------|------------------|
| EU-Declaration of Conformity<br>WAGO GmbH & Co. KG | -        | -                |
| Railway<br>WAGO GmbH & Co. KG                      | -        | Railway Ready    |
| UK-Declaration of Conformity<br>WAGO GmbH & Co. KG | -        | -                |

#### Approvals for marine applications



| Approval   | Standard | Certificate Name |
|--|----------|------------------|
| ABS<br>American Bureau of Shipping               | EN 60947 | 24-0152298-PDA   |
| DNV GL<br>Det Norske Veritas, Germanischer Lloyd | -        | TAE00001V2       |

#### Approvals for marine applications

|                               |   |                   |
|-------------------------------|---|-------------------|
| PRS<br>Polski Rejestr Statków | - | TE/1094/880590/23 |
|-------------------------------|---|-------------------|

**Downloads**

**Environmental Product Compliance**

|  |  |  |   |
|--|--|--|---|
| Compliance Search                          |  |  |   |
| Environmental Product Compliance 2006-1631 |  |  | ↓ |

**Documentation**

|           |            |                  |   |
|-----------|------------|------------------|---|
| Bid Text  |            |                  |   |
| 2006-1631 | 18.04.2019 | xml<br>4.13 KB   | ↓ |
| 2006-1631 | 17.04.2019 | docx<br>15.47 KB | ↓ |

**CAD/CAE-Data**

|                        |  |  |   |
|------------------------|--|--|---|
| CAD data               |  |  |   |
| 2D/3D Models 2006-1631 |  |  | ↓ |

|                             |  |  |   |
|-----------------------------|--|--|---|
| CAE data                    |  |  |   |
| EPLAN Data Portal 2006-1631 |  |  | ↓ |
| WSCAD Universe 2006-1631    |  |  | ↓ |
| ZUKEN Portal 2006-1631      |  |  | ↓ |

**1 Compatible Products**

**1.1 Required Accessories**

**1.1.1 End plate**

**1.1.1.1 End plate**



**Item No.: 2006-1691**  
End and intermediate plate; 1 mm thick; gray



**Item No.: 2006-1692**  
End and intermediate plate; 1 mm thick; orange



**Item No.: 2006-991**  
End plate for fuse terminal blocks; 2 mm thick; gray



**Item No.: 2006-992**  
End plate for fuse terminal blocks; 2 mm thick; orange

**1.2 Optional Accessories**

**1.2.1 Cover**

**1.2.1.1 Cover**



**Item No.: 2006-191**  
Lockout cap; for wire insertion and actuating opening; gray

## 1.2.2 DIN-rail

### 1.2.2.1 Mounting accessories



**Item No.: 210-196**

Aluminum carrier rail; 35 x 8.2 mm; 1.6 mm thick; 2 m long; unslotted; similar to EN 60715; silver-colored



**Item No.: 210-198**

Copper carrier rail; 35 x 15 mm; 2.3 mm thick; 2 m long; unslotted; according to EN 60715; copper-colored



**Item No.: 210-508**

Steel carrier rail; 35 x 15 mm; 1.5 mm thick; 2 m long; slotted; galvanized; similar to EN 60715; silver-colored



**Item No.: 210-197**

Steel carrier rail; 35 x 15 mm; 1.5 mm thick; 2 m long; slotted; similar to EN 60715; silver-colored



**Item No.: 210-506**

Steel carrier rail; 35 x 15 mm; 1.5 mm thick; 2 m long; unslotted; galvanized; similar to EN 60715; silver-colored



**Item No.: 210-114**

Steel carrier rail; 35 x 15 mm; 1.5 mm thick; 2 m long; unslotted; similar to EN 60715; silver-colored



**Item No.: 210-118**

Steel carrier rail; 35 x 15 mm; 2.3 mm thick; 2 m long; unslotted; according to EN 60715; silver-colored



**Item No.: 210-115**

Steel carrier rail; 35 x 7.5 mm; 1 mm thick; 2 m long; slotted; according to EN 60715; "Hole width 18 mm; silver-colored



**Item No.: 210-112**

Steel carrier rail; 35 x 7.5 mm; 1 mm thick; 2 m long; slotted; according to EN 60715; "Hole width 25 mm; silver-colored



**Item No.: 210-504**

Steel carrier rail; 35 x 7.5 mm; 1 mm thick; 2 m long; slotted; galvanized; according to EN 60715; silver-colored



**Item No.: 210-113**

Steel carrier rail; 35 x 7.5 mm; 1 mm thick; 2 m long; unslotted; according to EN 60715; silver-colored



**Item No.: 210-505**

Steel carrier rail; 35 x 7.5 mm; 1 mm thick; 2 m long; unslotted; galvanized; according to EN 60715; silver-colored

## 1.2.3 Installation

### 1.2.3.1 Cover



**Item No.: 709-156**

Cover; Type 3; suitable for cover carrier, type 3; 1 m long; transparent

### 1.2.3.2 Cover carrier



**Item No.: 709-169**

Cover carrier; Type 3; incl. fixing/retaining screws and knurled nut; suitable for 279 to 282 and 880 Series rail-mounted terminal blocks; suitable for 264 Series miniature rail-mounted terminal blocks; suitable for 270 Series sensor and actuator terminal blocks; gray

## 1.2.4 Jumper

### 1.2.4.1 Jumper



**Item No.: 2006-402**

Jumper; 2-way; insulated; light gray



**Item No.: 2006-403**

Jumper; 3-way; insulated; light gray



**Item No.: 2006-404**

Jumper; 4-way; insulated; light gray



**Item No.: 2006-405**

Jumper; 5-way; insulated; light gray



**Item No.: 2006-433**

Jumper; from 1 to 3; insulated; light gray



**Item No.: 2006-434**

Jumper; from 1 to 4; insulated; light gray



**Item No.: 2006-435**

Jumper; from 1 to 5; insulated; light gray



**Item No.: 2006-405/011-000**

Star point jumper; 3-way; insulated; light gray

1.2.5 Locking system

1.2.5.1 Locking system



**Item No.: 210-254**

Interlocking link; mechanically locks multiple links; 1 m long; transparent

1.2.6 Marking

1.2.6.1 Marker

**Item No.: 2009-145/000-006**

Mini-WSB Inline; for Smart Printer; 1700 pieces on roll; stretchable 5 - 5.2 mm; plain; snap-on type; blue

**Item No.: 2009-145/000-007**

Mini-WSB Inline; for Smart Printer; 1700 pieces on roll; stretchable 5 - 5.2 mm; plain; snap-on type; gray

**Item No.: 2009-145/000-023**

Mini-WSB Inline; for Smart Printer; 1700 pieces on roll; stretchable 5 - 5.2 mm; plain; snap-on type; green

**Item No.: 2009-145/000-012**

Mini-WSB Inline; for Smart Printer; 1700 pieces on roll; stretchable 5 - 5.2 mm; plain; snap-on type; orange

**Item No.: 2009-145/000-005**

Mini-WSB Inline; for Smart Printer; 1700 pieces on roll; stretchable 5 - 5.2 mm; plain; snap-on type; red

**Item No.: 2009-145/000-024**

Mini-WSB Inline; for Smart Printer; 1700 pieces on roll; stretchable 5 - 5.2 mm; plain; snap-on type; violet

**Item No.: 2009-145**

Mini-WSB Inline; for Smart Printer; 1700 pieces on roll; stretchable 5 - 5.2 mm; plain; snap-on type; white

**Item No.: 2009-145/000-002**

Mini-WSB Inline; for Smart Printer; 1700 pieces on roll; stretchable 5 - 5.2 mm; plain; snap-on type; yellow



**Item No.: 248-501/000-006**

Mini-WSB marking card; as card; not stretchable; plain; snap-on type; blue

**Item No.: 248-501/000-007**

Mini-WSB marking card; as card; not stretchable; plain; snap-on type; gray

**Item No.: 248-501/000-023**

Mini-WSB marking card; as card; not stretchable; plain; snap-on type; green

**Item No.: 248-501/000-017**

Mini-WSB marking card; as card; not stretchable; plain; snap-on type; light green



**Item No.: 248-501/000-012**

Mini-WSB marking card; as card; not stretchable; plain; snap-on type; orange

**Item No.: 248-501/000-005**

Mini-WSB marking card; as card; not stretchable; plain; snap-on type; red

**Item No.: 248-501/000-024**

Mini-WSB marking card; as card; not stretchable; plain; snap-on type; violet

**Item No.: 248-501**

Mini-WSB marking card; as card; not stretchable; plain; snap-on type; white



**Item No.: 248-501/000-002**

Mini-WSB marking card; as card; not stretchable; plain; snap-on type; yellow

**Item No.: 793-5501/000-006**

WMB marking card; as card; for terminal block width 5 - 17.5 mm; stretchable 5 - 5.2 mm; plain; snap-on type; blue

**Item No.: 793-5501/000-014**

WMB marking card; as card; for terminal block width 5 - 17.5 mm; stretchable 5 - 5.2 mm; plain; snap-on type; brown

**Item No.: 793-5501/000-007**

WMB marking card; as card; for terminal block width 5 - 17.5 mm; stretchable 5 - 5.2 mm; plain; snap-on type; gray



**Item No.: 793-5501/000-023**

WMB marking card; as card; for terminal block width 5 - 17.5 mm; stretchable 5 - 5.2 mm; plain; snap-on type; green

**Item No.: 793-5501/000-017**

WMB marking card; as card; for terminal block width 5 - 17.5 mm; stretchable 5 - 5.2 mm; plain; snap-on type; light green

**Item No.: 793-5501/000-012**

WMB marking card; as card; for terminal block width 5 - 17.5 mm; stretchable 5 - 5.2 mm; plain; snap-on type; orange

**Item No.: 793-5501/000-005**

WMB marking card; as card; for terminal block width 5 - 17.5 mm; stretchable 5 - 5.2 mm; plain; snap-on type; red



**Item No.: 793-5501/000-024**

WMB marking card; as card; for terminal block width 5 - 17.5 mm; stretchable 5 - 5.2 mm; plain; snap-on type; violet

**Item No.: 793-5501**

WMB marking card; as card; for terminal block width 5 - 17.5 mm; stretchable 5 - 5.2 mm; plain; snap-on type; white

**Item No.: 793-5501/000-002**

WMB marking card; as card; for terminal block width 5 - 17.5 mm; stretchable 5 - 5.2 mm; plain; snap-on type; yellow

**Item No.: 793-501/000-006**

WMB marking card; as card; not stretchable; plain; snap-on type; blue



**Item No.: 793-501/000-007**

WMB marking card; as card; not stretchable; plain; snap-on type; gray

**Item No.: 793-501/000-023**

WMB marking card; as card; not stretchable; plain; snap-on type; green

**Item No.: 793-501/000-017**

WMB marking card; as card; not stretchable; plain; snap-on type; light green

**Item No.: 793-501/000-012**

WMB marking card; as card; not stretchable; plain; snap-on type; orange



**Item No.: 793-501/000-005**

WMB marking card; as card; not stretchable; plain; snap-on type; red

**Item No.: 793-501/000-024**

WMB marking card; as card; not stretchable; plain; snap-on type; violet

**Item No.: 793-501**

WMB marking card; as card; not stretchable; plain; snap-on type; white

**Item No.: 793-501/000-002**

WMB marking card; as card; not stretchable; plain; snap-on type; yellow



1.2.6.1 Marker



**Item No.: 2009-115/000-006**

WMB-Inline; for Smart Printer; 1500 pieces on roll; stretchable 5 - 5.2 mm; plain; snap-on type; blue



**Item No.: 2009-115/000-007**

WMB-Inline; for Smart Printer; 1500 pieces on roll; stretchable 5 - 5.2 mm; plain; snap-on type; gray



**Item No.: 2009-115/000-023**

WMB-Inline; for Smart Printer; 1500 pieces on roll; stretchable 5 - 5.2 mm; plain; snap-on type; green



**Item No.: 2009-115/000-017**

WMB-Inline; for Smart Printer; 1500 pieces on roll; stretchable 5 - 5.2 mm; plain; snap-on type; light green



**Item No.: 2009-115/000-012**

WMB-Inline; for Smart Printer; 1500 pieces on roll; stretchable 5 - 5.2 mm; plain; snap-on type; orange



**Item No.: 2009-115/000-005**

WMB-Inline; for Smart Printer; 1500 pieces on roll; stretchable 5 - 5.2 mm; plain; snap-on type; red



**Item No.: 2009-115/000-024**

WMB-Inline; for Smart Printer; 1500 pieces on roll; stretchable 5 - 5.2 mm; plain; snap-on type; violet



**Item No.: 2009-115**

WMB-Inline; for Smart Printer; 1500 pieces on roll; stretchable 5 - 5.2 mm; plain; snap-on type; white



**Item No.: 2009-115/000-002**

WMB-Inline; for Smart Printer; 1500 pieces on roll; stretchable 5 - 5.2 mm; plain; snap-on type; yellow

1.2.6.2 Marker carrier



**Item No.: 2009-198**

Adaptor; gray

1.2.6.3 Marking strip



**Item No.: 2009-110**

Marking strips; for Smart Printer; on reel; not stretchable; plain; snap-on type; white

1.2.7 Protective warning marker

1.2.7.1 Cover



**Item No.: 2006-115**

Protective warning marker; for 5 terminal blocks; with high-voltage symbol, black; yellow

1.2.8 Screwless end stop

1.2.8.1 Mounting accessories



**Item No.: 249-117**

Screwless end stop; 10 mm wide; for DIN-rail 35 x 15 and 35 x 7.5; gray



**Item No.: 249-116**

Screwless end stop; 6 mm wide; for DIN-rail 35 x 15 and 35 x 7.5; gray

## 1.2.9 Test and measurement

### 1.2.9.1 Testing accessories



Item No.: 210-136

Test plug; 2 mm Ø; with 500 mm cable; red

## 1.2.10 Tool

### 1.2.10.1 Operating tool



Item No.: 210-721

Operating tool; Blade: 5.5 x 0.8 mm; with a partially insulated shaft; multicoloured

## Installation Notes

### Conductor termination

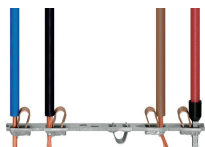

All conductor types at a glance

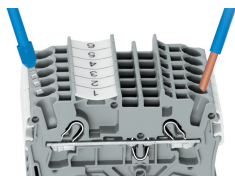

Push-in termination of solid and ferruled conductors

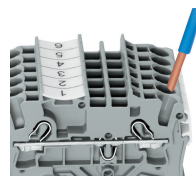

**Inserting a conductor via push-in termination:**  
Solid conductors with cross-sections from either one size above, or up to two sizes below, the rated cross-section can be simply pushed in – no tools needed.

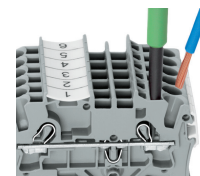

**Inserting a conductor via operating tool:**  
Connecting fine-stranded conductors without ferrules, or small cross-sectional conductors that cannot be pushed in, is performed similarly to the original CAGE CLAMP® – just use an operating tool.  
**Advantage:**  
To open the clamp, the operating tool is inserted vertically. The conductor entry is less than 15 degrees for easier wiring.

### Commoning

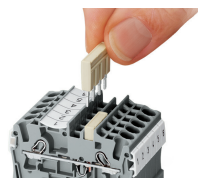

Insert push-in type jumper bar and push down until it hits backstop.

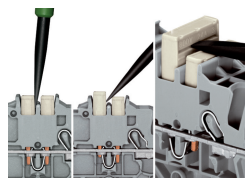

**Removing a push-in type jumper bar:**  
Insert the operating tool between the jumper and partition wall of the dual jumper slots, then lift up the jumper.  
Place the operating tool in the center of jumpers for up to five contacts (see above), or alternately on both sides for jumpers with more than five contacts.

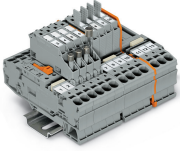

Pivoting fuse holder with spare fuse holder

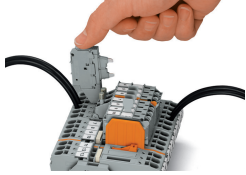

**Fused disconnect terminal block with a pivoting fuse holder**  
 Pivot the fuse holder into the locked open position.

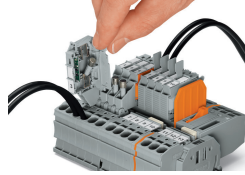

**Fused disconnect terminal block with a pivoting fuse holder**  
 Fuse replacement:  
 Open the cover to replace the fuse

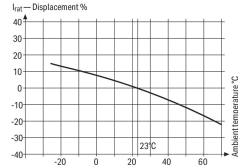
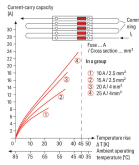
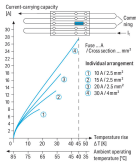

Information from the mini-automotive, blade-type fuse manufacturers

| Operating Temp °C | %   | $I_T$ |
|-------------------|-----|-------|
| 25                | 14  | 0.877 |
| 15                | 13  | 0.885 |
| 5                 | 12  | 0.893 |
| -5                | 11  | 0.901 |
| -15               | 10  | 0.909 |
| -25               | 9   | 0.917 |
| -35               | 8   | 0.925 |
| -45               | 7   | 0.933 |
| -55               | 6   | 0.941 |
| -65               | 5   | 0.949 |
| -75               | 4   | 0.957 |
| -85               | 3   | 0.965 |
| -95               | 2   | 0.973 |
| -105              | 1   | 0.981 |
| -115              | 0   | 0.989 |
| -125              | -1  | 0.997 |
| -135              | -2  | 1.005 |
| -145              | -3  | 1.013 |
| -155              | -4  | 1.021 |
| -165              | -5  | 1.029 |
| -175              | -6  | 1.037 |
| -185              | -7  | 1.045 |
| -195              | -8  | 1.053 |
| -205              | -9  | 1.061 |
| -215              | -10 | 1.069 |
| -225              | -11 | 1.077 |
| -235              | -12 | 1.085 |
| -245              | -13 | 1.093 |
| -255              | -14 | 1.101 |
| -265              | -15 | 1.109 |
| -275              | -16 | 1.117 |
| -285              | -17 | 1.125 |
| -295              | -18 | 1.133 |
| -305              | -19 | 1.141 |
| -315              | -20 | 1.149 |
| -325              | -21 | 1.157 |
| -335              | -22 | 1.165 |

**Application Notes on Terminal Blocks for Glass Cartridge Fuses**  
 Diagram: "Individual Arrangement"

**Application Notes on Terminal Blocks for Glass Cartridge Fuses**  
 Diagram: "Block Arrangement"

**Application Notes on Terminal Blocks for Glass Cartridge Fuses**

Nominal current ratings for fuse cartridges are defined differently in international standards. This is why the recommended continuous current-carrying capacity of the fuses is a max. 80% of their nominal current according to DIN 72581/ Part 3 (for a surrounding air temperature of 23°C).  
 Selecting the correct fuse cartridge is important for product safety within applications, as well as for fuse cartridge service life and reliability. Fuse cartridges will only operate perfectly as protection components (break-off point) if they are properly selected and used as intended (i.e., according to the state of the technology and valid specifications, as well as data sheet characteristics), according to basic safety requirements (i.e., persons, animals and property must be protected against hazards).

Concerning product safety, fuse cartridges must generally be tested under both normal and faulty operating conditions within your application.

**Marking**

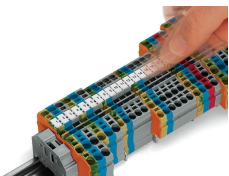

Snapping WMB Inline markers into marker slots.

