

Data Sheet | Item Number: 2006-1611

2-conductor fuse terminal block; with pivoting fuse holder; for 5 x 20 mm miniature metric fuse; without blown fuse indication; for DIN-rail 35 x 15 and 35 x 7.5; 6 mm²; Push-in CAGE CLAMP®; gray

<https://www.wago.com/2006-1611>

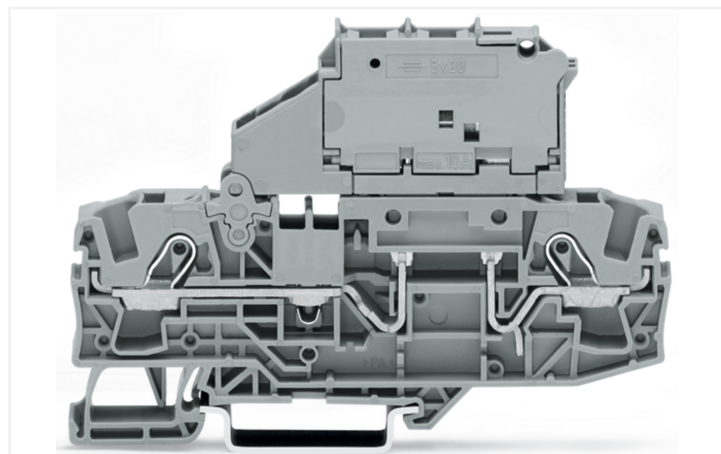
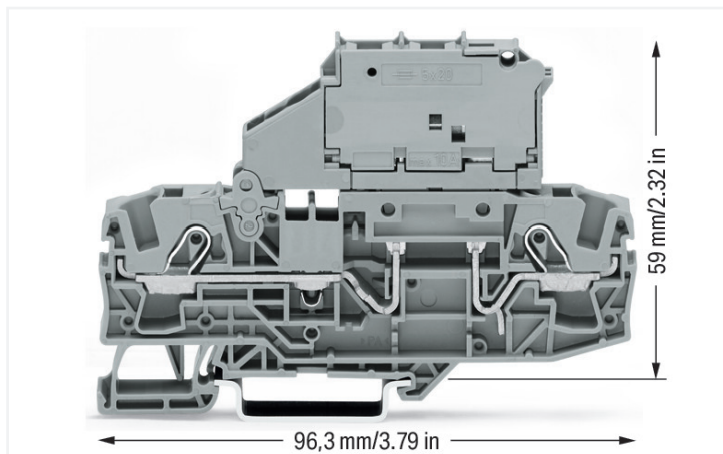

Color: ■ gray

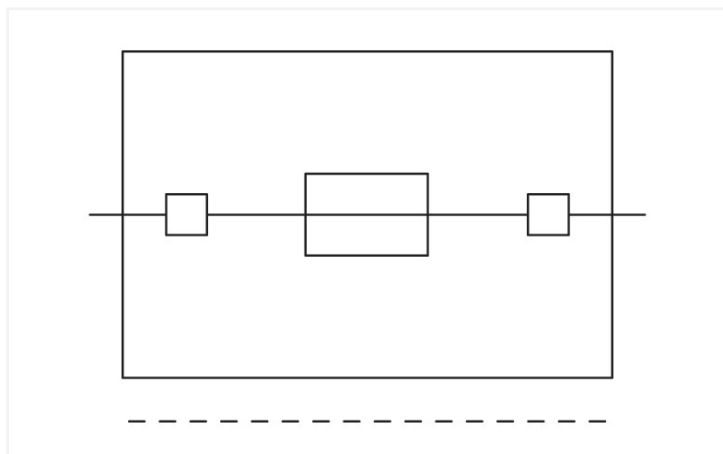

Fuse terminal block, 2006 Series, gray

This fuse terminal block (item number 2006-1611) is designed for quick and easy connections. Strip lengths must be between 13 and 15 mm when connecting conductors to this fuse terminal block. This product incorporates conductor terminals and utilizes Push-in CAGE CLAMP®. Our Push-in CAGE CLAMP® is a universal, maintenance-free connection solution for all conductor types, boasting a key feature: both solid and fine-stranded conductors with ferrules can be directly inserted without the need for tools or any preparation, such as crimping the ferrule. This fuse terminal block is suitable for conductor cross sections ranging from 0.5 mm² to 10 mm².

Notes

Safety Information

The 2 mm test slot is only approved for high impedance measurement up to max. 100 mA.

Electrical data

Ratings per	IEC/EN 60947-7-3		
Overvoltage category	III	III	II
Pollution degree	3	2	2
Nominal voltage	800 V	-	-
Rated impulse withstand voltage	8 kV	-	-
Rated current	10 A	-	-

Ratings per IEC/EN – Notes	
Ratings (note)	Electrical ratings are given by the fuse.

Approvals per	UL 1059		
Use group	B	C	D
Rated voltage	600 V	600 V	-
Rated current	15 A	15 A	-

Approvals per	CSA 22.2 No 158		
Use group	B	C	D
Rated voltage	600 V	600 V	-
Rated current	15 A	15 A	-

Power Loss

Power loss (max.) $P_{I(max)}$ (note)	When selecting glass cartridge fuses, make sure that the maximum power loss listed below is not exceeded. The power loss is determined according to IEC or EN 60947-7-3/VDE 0611-6 at 23°C. The temperature rise of the terminal block must be checked according to their application and mounting. Higher ambient temperatures represent an additional impact on miniature fuses. Therefore, in such applications, the rated current must be reduced if necessary. More details are available from the manufacturers.
---------------------------------------	--

Maximum power loss P_{loss} of fuse insert for overload and short-circuit protection (individual arrangement) 1.6 W

Maximum power loss P_{loss} of fuse insert for overload and short-circuit protection (block arrangement) 1.6 W

Power loss P_I max. short-circuit protection (individual arrangement) 2.5 W

Power loss P_{loss} (max.) of fuse cartridge for short-circuit protection (block arrangement) 2.5 W

General information

Fuse receptacle	pivoting
Fuse type	Cylindrical fuse; 5 x 20 mm
Wiring direction	Front-entry wiring

Connection Data

Clamping units	2
Total number of potentials	1
Number of levels	1
Number of jumper slots	2

Connection 1

Connection technology	Push-in CAGE CLAMP®
Actuation type	Operating tool
Connectable conductor materials	Copper
Nominal cross-section	6 mm ²
Solid conductor	0.5 ... 10 mm ² / 20 ... 8 AWG
Solid conductor; push-in termination	2.5 ... 10 mm ² / 14 ... 8 AWG
Fine-stranded conductor	0.5 ... 10 mm ² / 20 ... 8 AWG
Fine-stranded conductor; with insulated ferrule	0.5 ... 6 mm ² / 20 ... 10 AWG
Fine-stranded conductor; with ferrule; push-in termination	2.5 ... 6 mm ² / 16 ... 10 AWG
Note (conductor cross-section)	Depending on the conductor characteristic, a conductor with a smaller cross-section can also be inserted via push-in termination.
Strip length	13 ... 15 mm / 0.51 ... 0.59 inches
Wiring direction	Front-entry wiring

Physical data

Width	7.5 mm / 0.295 inches
Height	96.3 mm / 3.791 inches
Depth from upper-edge of DIN-rail	59 mm / 2.323 inches

Mechanical data

Mounting type	DIN-35 rail
Marking level	Center/side marking

Material data

Note (material data)	Information on material specifications can be found here
Color	gray
Material group	I
Insulation material (main housing)	Polyamide (PA66)
Flammability class per UL94	V0
Fire load	0.458 MJ
Weight	25 g

Environmental requirements

Processing temperature	-35 ... +85 °C	Environmental Testing
Continuous operating temperature	-60 ... +105 °C	
		Test specification: DIN EN 50155 (VDE 0115-200):2022-06 Railway applications – Rolling stock – Electronic equipment
		Test procedure: DIN EN 61373 (VDE 0115-0106):2011-04 Railway applications – Rolling stock equipment – Vibration and shock tests
		Spectrum/Mounting location Service life test, Category 1, Class A/B
		Functional test with noise-like oscillations Test passed according to Section 8 of the standard
		Frequency $f_1 = 5 \text{ Hz}$ to $f_2 = 150 \text{ Hz}$
		Acceleration 0.101g (highest test level used for all axes)
		Test duration per axis 10 min.
		Test directions X, Y and Z axes
		Monitoring of contact faults and interruptions Passed
		Voltage drop measurement before and after each axis Passed
		Simulated service life test through increased levels of noise-like oscillations Test passed according to Section 9 of the standard
		Frequency $f_1 = 5 \text{ Hz}$ to $f_2 = 150 \text{ Hz}$
		Acceleration 0.572g (highest test level used for all axes)
		Test duration per axis 5 h
		Test directions X, Y and Z axes
		Extended testing: Monitoring of contact faults and interruptions Passed
		Extended testing: Voltage drop measurement before and after each axis Passed
		Shock test Test passed according to Section 10 of the standard
		Shock pulse form Half sine
		Acceleration 5g (highest test level used for all axes)
		Shock duration 30 ms
		Number of shocks (per axis) 3 pos. und 3 neg.
		Test directions X, Y and Z axes

Environmental Testing

Extended testing: Monitoring of contact faults and interruptions	Passed
Extended testing: Voltage drop measurement before and after each axis	Passed
Vibration and shock stress for rolling stock equipment	Passed

Commercial data

Product Group	22 (TOPJOB S)
PU (SPU)	25 pcs
Packaging type	Box
Country of origin	CN
GTIN	4045454821166
Customs tariff number	85369095000

Product Classification

UNSPSC	39121410
eCl@ss 10.0	27-14-11-16
eCl@ss 9.0	27-14-11-16
ETIM 9.0	EC000899
ETIM 10.0	EC000899
ECCN	NO US CLASSIFICATION

Environmental Product Compliance

RoHS Compliance Status	Compliant, No Exemption
------------------------	-------------------------

Approvals / Certificates

General approvals



Approval	Standard	Certificate Name
CCA DEKRA Certification B.V.	IEC 60947	71-122840 REV.1
CCA DEKRA Certification B.V.	EN 60947	NTR NL-8060
CSA CSA Group	C22.2 No. 158	1543858
UR Underwriters Laboratories Inc.	UL 1059	E45172

Declarations of conformity and manufacturer's declarations



Approval	Standard	Certificate Name
EU-Declaration of Conformity WAGO GmbH & Co. KG	-	-
Railway WAGO GmbH & Co. KG	-	Railway Ready
UK-Declaration of Conformity WAGO GmbH & Co. KG	-	-

Approvals for marine applications



Approval	Standard	Certificate Name
ABS American Bureau of Shipping	EN 60947	24-0152298-PDA
DNV GL Det Norske Veritas, Germanischer Lloyd	-	TAE00001V2

Approvals for marine applications

LR Lloyds Register	EN 60947	LR23325966TA
PRS Polski Rejestr Statków	-	TE/1094/880590/23

Downloads

Environmental Product Compliance

Compliance Search

Environmental Product Compliance 2006-1611



Documentation

Bid Text

2006-1611	17.04.2019	xml 4.13 KB	
2006-1611	17.04.2019	docx 15.56 KB	

CAD/CAE-Data

CAD data

2D/3D Models
2006-1611



CAE data

EPLAN Data Portal
2006-1611



WSCAD Universe
2006-1611



ZUKEN Portal
2006-1611



1 Compatible Products

1.1 Required Accessories

1.1.1 End plate

1.1.1.1 End plate



[Item No.: 2006-1691](#)

End and intermediate plate; 1 mm thick; gray



[Item No.: 2006-1692](#)

End and intermediate plate; 1 mm thick; orange



[Item No.: 2006-991](#)

End plate for fuse terminal blocks; 2 mm thick; gray



[Item No.: 2006-992](#)

End plate for fuse terminal blocks; 2 mm thick; orange

1.2 Optional Accessories

1.2.1 Cover

1.2.1.1 Cover



[Item No.: 2006-191](#)

Lockout cap; for wire insertion and actuating opening; gray

1.2.2 DIN-rail

1.2.2.1 Mounting accessories



Item No.: 210-196

Aluminum carrier rail; 35 x 8.2 mm; 1.6 mm thick; 2 m long; unslotted; similar to EN 60715; silver-colored



Item No.: 210-198

Copper carrier rail; 35 x 15 mm; 2.3 mm thick; 2 m long; unslotted; according to EN 60715; copper-colored



Item No.: 210-508

Steel carrier rail; 35 x 15 mm; 1.5 mm thick; 2 m long; slotted; galvanized; similar to EN 60715; silver-colored



Item No.: 210-197

Steel carrier rail; 35 x 15 mm; 1.5 mm thick; 2 m long; slotted; similar to EN 60715; silver-colored



Item No.: 210-506

Steel carrier rail; 35 x 15 mm; 1.5 mm thick; 2 m long; unslotted; galvanized; similar to EN 60715; silver-colored



Item No.: 210-114

Steel carrier rail; 35 x 15 mm; 1.5 mm thick; 2 m long; unslotted; similar to EN 60715; silver-colored



Item No.: 210-118

Steel carrier rail; 35 x 15 mm; 2.3 mm thick; 2 m long; unslotted; according to EN 60715; silver-colored



Item No.: 210-115

Steel carrier rail; 35 x 7.5 mm; 1 mm thick; 2 m long; slotted; according to EN 60715; "Hole width 18 mm; silver-colored



Item No.: 210-112

Steel carrier rail; 35 x 7.5 mm; 1 mm thick; 2 m long; slotted; according to EN 60715; "Hole width 25 mm; silver-colored



Item No.: 210-504

Steel carrier rail; 35 x 7.5 mm; 1 mm thick; 2 m long; slotted; galvanized; according to EN 60715; silver-colored



Item No.: 210-113

Steel carrier rail; 35 x 7.5 mm; 1 mm thick; 2 m long; unslotted; according to EN 60715; silver-colored



Item No.: 210-505

Steel carrier rail; 35 x 7.5 mm; 1 mm thick; 2 m long; unslotted; galvanized; according to EN 60715; silver-colored

1.2.3 Installation

1.2.3.1 Cover



Item No.: 709-156

Cover; Type 3; suitable for cover carrier, type 3; 1 m long; transparent

1.2.3.2 Cover carrier



Item No.: 709-169

Cover carrier; Type 3; incl. fixing/retaining screws and knurled nut; suitable for 279 to 282 and 880 Series rail-mounted terminal blocks; suitable for 264 Series miniature rail-mounted terminal blocks; suitable for 270 Series sensor and actuator terminal blocks; gray

1.2.4 Jumper

1.2.4.1 Jumper



Item No.: 2006-402

Jumper; 2-way; insulated; light gray



Item No.: 2006-403

Jumper; 3-way; insulated; light gray



Item No.: 2006-404

Jumper; 4-way; insulated; light gray



Item No.: 2006-405

Jumper; 5-way; insulated; light gray



Item No.: 2006-433

Jumper; from 1 to 3; insulated; light gray



Item No.: 2006-434

Jumper; from 1 to 4; insulated; light gray



Item No.: 2006-435

Jumper; from 1 to 5; insulated; light gray



Item No.: 2006-405/011-000

Star point jumper; 3-way; insulated; light gray

1.2.5 Locking system

1.2.5.1 Locking system



Item No.: 210-254

Interlocking link; mechanically locks multiple links; 1 m long; transparent

1.2.6 Marking

1.2.6.1 Marker

Item No.: 2009-145/000-006

Mini-WSB Inline; for Smart Printer; 1700 pieces on roll; stretchable 5 - 5.2 mm; plain; snap-on type; blue

Item No.: 2009-145/000-007

Mini-WSB Inline; for Smart Printer; 1700 pieces on roll; stretchable 5 - 5.2 mm; plain; snap-on type; gray

Item No.: 2009-145/000-023

Mini-WSB Inline; for Smart Printer; 1700 pieces on roll; stretchable 5 - 5.2 mm; plain; snap-on type; green

Item No.: 2009-145/000-012

Mini-WSB Inline; for Smart Printer; 1700 pieces on roll; stretchable 5 - 5.2 mm; plain; snap-on type; orange

Item No.: 2009-145/000-005

Mini-WSB Inline; for Smart Printer; 1700 pieces on roll; stretchable 5 - 5.2 mm; plain; snap-on type; red

Item No.: 2009-145/000-024

Mini-WSB Inline; for Smart Printer; 1700 pieces on roll; stretchable 5 - 5.2 mm; plain; snap-on type; violet

Item No.: 2009-145

Mini-WSB Inline; for Smart Printer; 1700 pieces on roll; stretchable 5 - 5.2 mm; plain; snap-on type; white

Item No.: 2009-145/000-002

Mini-WSB Inline; for Smart Printer; 1700 pieces on roll; stretchable 5 - 5.2 mm; plain; snap-on type; yellow



Item No.: 248-501/000-006

Mini-WSB marking card; as card; not stretchable; plain; snap-on type; blue

Item No.: 248-501/000-007

Mini-WSB marking card; as card; not stretchable; plain; snap-on type; gray

Item No.: 248-501/000-023

Mini-WSB marking card; as card; not stretchable; plain; snap-on type; green

Item No.: 248-501/000-017

Mini-WSB marking card; as card; not stretchable; plain; snap-on type; light green



Item No.: 248-501/000-012

Mini-WSB marking card; as card; not stretchable; plain; snap-on type; orange

Item No.: 248-501/000-005

Mini-WSB marking card; as card; not stretchable; plain; snap-on type; red

Item No.: 248-501/000-024

Mini-WSB marking card; as card; not stretchable; plain; snap-on type; violet

Item No.: 248-501

Mini-WSB marking card; as card; not stretchable; plain; snap-on type; white



Item No.: 248-501/000-002

Mini-WSB marking card; as card; not stretchable; plain; snap-on type; yellow

Item No.: 793-5501/000-006

WMB marking card; as card; for terminal block width 5 - 17.5 mm; stretchable 5 - 5.2 mm; plain; snap-on type; blue

Item No.: 793-5501/000-014

WMB marking card; as card; for terminal block width 5 - 17.5 mm; stretchable 5 - 5.2 mm; plain; snap-on type; brown

Item No.: 793-5501/000-007

WMB marking card; as card; for terminal block width 5 - 17.5 mm; stretchable 5 - 5.2 mm; plain; snap-on type; gray



Item No.: 793-5501/000-023

WMB marking card; as card; for terminal block width 5 - 17.5 mm; stretchable 5 - 5.2 mm; plain; snap-on type; green

Item No.: 793-5501/000-017

WMB marking card; as card; for terminal block width 5 - 17.5 mm; stretchable 5 - 5.2 mm; plain; snap-on type; light green

Item No.: 793-5501/000-012

WMB marking card; as card; for terminal block width 5 - 17.5 mm; stretchable 5 - 5.2 mm; plain; snap-on type; orange

Item No.: 793-5501/000-005

WMB marking card; as card; for terminal block width 5 - 17.5 mm; stretchable 5 - 5.2 mm; plain; snap-on type; red



Item No.: 793-5501/000-024

WMB marking card; as card; for terminal block width 5 - 17.5 mm; stretchable 5 - 5.2 mm; plain; snap-on type; violet

Item No.: 793-5501

WMB marking card; as card; for terminal block width 5 - 17.5 mm; stretchable 5 - 5.2 mm; plain; snap-on type; white

Item No.: 793-5501/000-002

WMB marking card; as card; for terminal block width 5 - 17.5 mm; stretchable 5 - 5.2 mm; plain; snap-on type; yellow

Item No.: 793-501/000-006

WMB marking card; as card; not stretchable; plain; snap-on type; blue



Item No.: 793-501/000-007

WMB marking card; as card; not stretchable; plain; snap-on type; gray

Item No.: 793-501/000-023

WMB marking card; as card; not stretchable; plain; snap-on type; green

Item No.: 793-501/000-017

WMB marking card; as card; not stretchable; plain; snap-on type; light green

Item No.: 793-501/000-012

WMB marking card; as card; not stretchable; plain; snap-on type; orange



Item No.: 793-501/000-005

WMB marking card; as card; not stretchable; plain; snap-on type; red

Item No.: 793-501/000-024

WMB marking card; as card; not stretchable; plain; snap-on type; violet

Item No.: 793-501

WMB marking card; as card; not stretchable; plain; snap-on type; white

Item No.: 793-501/000-002

WMB marking card; as card; not stretchable; plain; snap-on type; yellow

1.2.6.1 Marker



Item No.: 2009-115/000-006

WMB-Inline; for Smart Printer; 1500 pieces on roll; stretchable 5 - 5.2 mm; plain; snap-on type; blue



Item No.: 2009-115/000-007

WMB-Inline; for Smart Printer; 1500 pieces on roll; stretchable 5 - 5.2 mm; plain; snap-on type; gray



Item No.: 2009-115/000-023

WMB-Inline; for Smart Printer; 1500 pieces on roll; stretchable 5 - 5.2 mm; plain; snap-on type; green



Item No.: 2009-115/000-017

WMB-Inline; for Smart Printer; 1500 pieces on roll; stretchable 5 - 5.2 mm; plain; snap-on type; light green



Item No.: 2009-115/000-012

WMB-Inline; for Smart Printer; 1500 pieces on roll; stretchable 5 - 5.2 mm; plain; snap-on type; orange



Item No.: 2009-115/000-005

WMB-Inline; for Smart Printer; 1500 pieces on roll; stretchable 5 - 5.2 mm; plain; snap-on type; red



Item No.: 2009-115/000-024

WMB-Inline; for Smart Printer; 1500 pieces on roll; stretchable 5 - 5.2 mm; plain; snap-on type; violet



Item No.: 2009-115

WMB-Inline; for Smart Printer; 1500 pieces on roll; stretchable 5 - 5.2 mm; plain; snap-on type; white



Item No.: 2009-115/000-002

WMB-Inline; for Smart Printer; 1500 pieces on roll; stretchable 5 - 5.2 mm; plain; snap-on type; yellow

1.2.6.2 Marker carrier



Item No.: 2009-198

Adaptor; gray

1.2.6.3 Marking strip



Item No.: 2009-110

Marking strips; for Smart Printer; on reel; not stretchable; plain; snap-on type; white

1.2.7 Protective warning marker

1.2.7.1 Cover



Item No.: 2006-115

Protective warning marker; for 5 terminal blocks; with high-voltage symbol, black; yellow

1.2.8 Screwless end stop

1.2.8.1 Mounting accessories



Item No.: 249-117

Screwless end stop; 10 mm wide; for DIN-rail 35 x 15 and 35 x 7.5; gray



Item No.: 249-116

Screwless end stop; 6 mm wide; for DIN-rail 35 x 15 and 35 x 7.5; gray

1.2.9 Test and measurement

1.2.9.1 Testing accessories



Item No.: 210-136

Test plug; 2 mm Ø; with 500 mm cable; red

1.2.10 Tool

1.2.10.1 Operating tool



Item No.: 210-721

Operating tool; Blade: 5.5 x 0.8 mm; with a partially insulated shaft; multicoloured

Installation Notes

Conductor termination

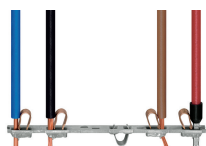

All conductor types at a glance

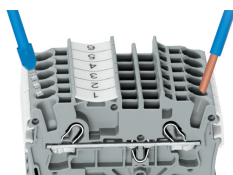

Push-in termination of solid and ferruled conductors

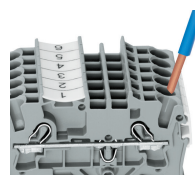

Inserting a conductor via push-in termination:
Solid conductors with cross-sections from either one size above, or up to two sizes below, the rated cross-section can be simply pushed in – no tools needed.

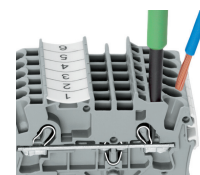

Inserting a conductor via operating tool:
Connecting fine-stranded conductors without ferrules, or small cross-sectional conductors that cannot be pushed in, is performed similarly to the original CAGE CLAMP® – just use an operating tool.
Advantage:
To open the clamp, the operating tool is inserted vertically. The conductor entry is less than 15 degrees for easier wiring.

Commoning

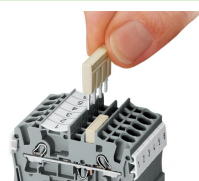

Insert push-in type jumper bar and push down until it hits backstop.

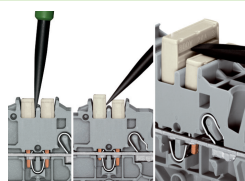

Removing a push-in type jumper bar:
Insert the operating tool between the jumper and partition wall of the dual jumper slots, then lift up the jumper.
Place the operating tool in the center of jumpers for up to five contacts (see above), or alternately on both sides for jumpers with more than five contacts.

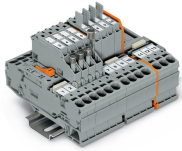

Pivoting fuse holder with spare fuse holder

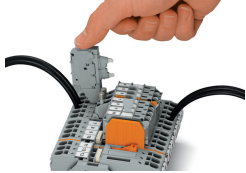

Fused disconnect terminal block with a pivoting fuse holder
 Pivot the fuse holder into the locked open position.

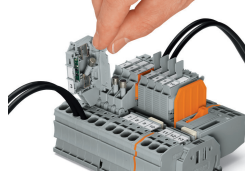

Fused disconnect terminal block with a pivoting fuse holder
 Fuse replacement:
 Open the cover to replace the fuse

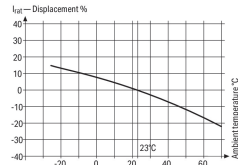
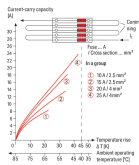
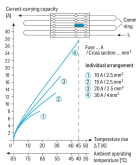

Information from the mini-automotive, blade-type fuse manufacturers

Operating Temp °C	%	I_{90}
25	14	0.877
15	13	0.885
5	12	0.893
-5	11	0.901
-15	10	0.909
-25	9	0.917
-35	8	0.925
-45	7	0.933
-55	6	0.941
-65	5	0.949
-75	4	0.957
-85	3	0.965
-95	2	0.973
-105	1	0.981
-115	0	0.989
-125	-1	0.997
-135	-2	1.005
-145	-3	1.013
-155	-4	1.021
-165	-5	1.029
-175	-6	1.037
-185	-7	1.045
-195	-8	1.053
-205	-9	1.061
-215	-10	1.069
-225	-11	1.077
-235	-12	1.085
-245	-13	1.093
-255	-14	1.101
-265	-15	1.109
-275	-16	1.117
-285	-17	1.125
-295	-18	1.133
-305	-19	1.141
-315	-20	1.149
-325	-21	1.157
-335	-22	1.165
-345	-23	1.173
-355	-24	1.181
-365	-25	1.189
-375	-26	1.197
-385	-27	1.205
-395	-28	1.213
-405	-29	1.221
-415	-30	1.229
-425	-31	1.237
-435	-32	1.245
-445	-33	1.253
-455	-34	1.261
-465	-35	1.269
-475	-36	1.277
-485	-37	1.285
-495	-38	1.293
-505	-39	1.301
-515	-40	1.309
-525	-41	1.317
-535	-42	1.325
-545	-43	1.333
-555	-44	1.341
-565	-45	1.349
-575	-46	1.357
-585	-47	1.365
-595	-48	1.373
-605	-49	1.381
-615	-50	1.389
-625	-51	1.397
-635	-52	1.405
-645	-53	1.413
-655	-54	1.421
-665	-55	1.429
-675	-56	1.437
-685	-57	1.445
-695	-58	1.453
-705	-59	1.461
-715	-60	1.469
-725	-61	1.477
-735	-62	1.485
-745	-63	1.493
-755	-64	1.501
-765	-65	1.509
-775	-66	1.517
-785	-67	1.525
-795	-68	1.533
-805	-69	1.541
-815	-70	1.549
-825	-71	1.557
-835	-72	1.565
-845	-73	1.573
-855	-74	1.581
-865	-75	1.589
-875	-76	1.597
-885	-77	1.605
-895	-78	1.613
-905	-79	1.621
-915	-80	1.629
-925	-81	1.637
-935	-82	1.645
-945	-83	1.653
-955	-84	1.661
-965	-85	1.669
-975	-86	1.677
-985	-87	1.685
-995	-88	1.693

Application Notes on Terminal Blocks for Glass Cartridge Fuses
 Diagram: "Individual Arrangement"

Application Notes on Terminal Blocks for Glass Cartridge Fuses
 Diagram: "Block Arrangement"

Application Notes on Terminal Blocks for Glass Cartridge Fuses

Nominal current ratings for fuse cartridges are defined differently in international standards. This is why the recommended continuous current-carrying capacity of the fuses is a max. 80% of their nominal current according to DIN 72581/ Part 3 (for a surrounding air temperature of 23°C).
 Selecting the correct fuse cartridge is important for product safety within applications, as well as for fuse cartridge service life and reliability. Fuse cartridges will only operate perfectly as protection components (break-off point) if they are properly selected and used as intended (i.e., according to the state of the technology and valid specifications, as well as data sheet characteristics), according to basic safety requirements (i.e., persons, animals and property must be protected against hazards).

Concerning product safety, fuse cartridges must generally be tested under both normal and faulty operating conditions within your application.

Marking

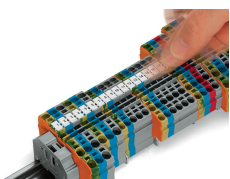

Snapping WMB Inline markers into marker slots.

