

UPS KEOR DK R/T 5-6-10 kVA

Installation and Maintenance Manual



Table of Contents

1. Introduction.....	4
1.1 General remarks.....	4
1.2 Manufacturer's liability and guarantee.....	5
1.2.1 Guarantee terms.....	5
1.2.2 Extension of the guarantee and maintenance contracts.....	6
1.3 Copyright.....	6
2. Regulatory and safety requirements.....	7
2.1 Definitions of "Skilled Technician" and "Operator".....	7
2.1.1 Skilled Technician.....	7
2.1.2 Operator.....	8
2.2 Personal Protective Equipment.....	8
2.3 Hazard signs in the workplace.....	9
2.4 Signs on the equipment.....	9
2.5 Batteries.....	10
2.6 Installation and maintenance.....	10
2.7 Cybersecurity.....	12
3. Equipment check and transportation.....	13
3.1 Visual check.....	13
3.2 Equipment check.....	13
3.3 Transportation.....	14
3.4 Positioning constraints.....	14
4. Installation.....	15
4.1 Views.....	15
4.1.1 Rear Panel.....	15
4.1.2 Operation Panel.....	17
4.2 Mechanical Installation.....	19
4.2.1 Tower installation.....	19
4.2.2 Rack mount installation.....	19
4.3 Electrical connection.....	20
4.3.1 Protection from overloads and short-circuits.....	20
4.3.2 Wiring operation.....	20
4.3.2.1 5kVA and 6kVA unit with battery cabinet.....	21
4.3.2.2 10kVA unit with battery cabinet.....	22
4.4 Communication.....	23
4.4.1 RS232.....	23
4.4.2 USB.....	23
4.4.3 EPO and input dry contacts.....	24
5. Configuration and starting-up.....	25
5.1 Pre-start-up checks.....	25

5.2 Start-up procedure	25
5.3 UPS Default Data and Special Function Execution	25
6. Maintenance	26
6.1 Preventive maintenance	26
6.2 Periodical checks	26
6.3 Ordinary and extraordinary maintenance	26
6.4 Troubleshooting	27
6.4.1 Common faults	27
6.4.2 Error codes	28
6.4.3 Beep codes	29
7. Warehousing	30
7.1 UPS	30
7.2 Batteries	30
8. Dismantling	31
8.1 Battery disposal	31
8.2 UPS dismantling	31
8.3 Electronic component dismantling	31
9. Technical characteristics	32
10. Technical data	38

1. Introduction

 The instructions in this manual are intended for a **SKILLED TECHNICIAN** (paragraph 2.2.1) to provide information on how to install and maintain the UPS.

 You can download the full manual from the UPSservice App.



1.1 General remarks

The purpose of this manual is to provide to the skilled technician:

- instructions to safely install the 5 kVA, 6kVA and 10 kVA Keor DK R/T UPS (also called only “UPS” or “equipment” in the rest of the manual).
- information to carry out ordinary maintenance procedures. Extraordinary maintenance operations are not dealt with because they are the sole preserve of the LEGRAND Technical Support Service.

The manual refers to laws, directives, and standards that the skilled technician is required to be aware of and consult. It does not substitute the skill of technical personnel who must have received adequate preliminary training.

The intended use and configurations envisaged for the equipment as shown in this manual are the only ones allowed by LEGRAND (also called "Manufacturer" in the rest of the manual). Any other use or configuration must be previously agreed with the Manufacturer in writing and the written agreement will become part of the installation and user manuals.

This manual is not a specification; therefore, LEGRAND reserves the right to make any changes to data without prior notice. It also complies with the directives and standards in force at the time of its release. The version of the manual updated to its latest release is available at ups.legrand.com. The original text of this publication, drafted in English, is the only reference for the resolution of disputes of interpretation linked to translations into other languages.

Some operations are shown in graphic symbols that draw the attention of the reader to the danger or the importance they imply:



This symbol indicates a danger entailing a high degree of risk that, if not avoided, will lead to death or severe injury or considerable damage to the equipment, people, and things around it.



This symbol indicates a danger entailing a level of risk that, if not avoided, could lead to minor or moderate injury or material damage to the equipment, people, and things around it.

 This symbol indicates essential information which should be read carefully.

The manual must be kept in a safe, dry place and must always be available for its entire lifetime. It is recommended to make a copy of it and file it away. In case of need (for example in case of damage that even partially compromises its consultation) the skilled technician is required to get a new copy from the Manufacturer.

If information is exchanged with the Manufacturer or the authorized assistance personnel, it is essential to refer to the equipment's rating plate data and serial number.

1.2 Manufacturer's liability and guarantee

The skilled technician and the operator shall scrupulously comply with the precautions and installation instructions indicated in the manuals. They must:

- always work within the operating limits of the equipment.
- always carry out constant and careful maintenance through a skilled technician who complies with all the procedures indicated in the installation and maintenance manual.

The Manufacturer declines all indirect or direct responsibility arising from:

- assembly and cabling made by personnel not fully qualified according to national standards to work on equipment presenting electrical hazards.
- assembly and cabling made without using safety equipment and tools required by national safety standards.
- failure to observe the installation and maintenance instructions and use of the equipment which differs from the specifications in the manuals.
- use by personnel who have not read and thoroughly understood the content of the user manual.
- use that does not comply with the specific standards used in the country where the equipment is installed.
- modifications made to the equipment, software, functioning logic unless they have been authorized by the Manufacturer in writing.
- repairs that have not been authorized by the LEGRAND Technical Support Service.
- damage caused intentionally, through negligence, by acts of God, natural phenomena, fire or liquid infiltration.
- damage caused using batteries and protections not specified in the manual.
- accidents caused by a wrong assembly of the safety protections or due to the lack of application of the safety labels.

The transfer of the equipment to others also requires handing over all the manuals. Failure to do it will automatically nullify any right of the buyer, including the terms of the guarantee where applicable.

If the equipment is sold to a third party in a country where a different language is spoken, the original owner shall be responsible for providing a faithful translation of this manual in the language of the country where the equipment will be used.

1.2.1 Guarantee terms

The guarantee terms may vary depending on the country where the UPS is sold. Check the validity and duration with LEGRAND's local sale representative.

If there should be a fault in the product, contact the LEGRAND Technical Support Service which will provide all the instructions on what to do.

Do not send anything back without LEGRAND's prior authorization.

The guarantee becomes void if the UPS has not been brought into service by a properly trained skilled technician (see paragraph 2.2.1).

If during the guarantee period the UPS does not conform to the characteristics and performance laid down in this manual, LEGRAND at its discretion will repair or replace the UPS and relative parts. All the repaired or replaced parts will remain LEGRAND's property.

LEGRAND is not responsible for costs such as:

- losses of profits or earnings.
- losses of equipment, data or software.
- claims by third parties.
- any damage to persons or things due to improper use, unauthorized technical alterations or modifications.
- any damage to persons or things due to installations where the full compliance with the standard regulating the specific usage applications have not been guaranteed.

1.2.2 Extension of the guarantee and maintenance contracts

The standard guarantee can be consolidated in a single extension contract (maintenance contract). Once the guarantee period has passed, LEGRAND is available for giving a technical assistance service able to meet all requirements, maintenance agreements, 24/7 availability and monitoring. Please, contact the LEGRAND Technical Support Service for further information.

1.3 Copyright

The information contained in this manual cannot be disclosed to any third party. Any partial or total duplication of the manual by photocopying or other systems, including electronic scanning, which is not authorized in writing by LEGRAND, violates copyright conditions and may lead to prosecution.

2. Regulatory and safety requirements

 Before carrying out any operation on the equipment, it is necessary to read the entire manual carefully, especially this chapter. Look after this manual carefully and consult it repeatedly during installation and maintenance by a skilled technician.

 Keor DK R/T 5-6-10 kVA is a category C3 UPS according to the standard EN IEC 62040-2. The UPS is a product for commercial and industrial application in the second environment – installation restrictions or additional measures may be needed to prevent disturbances.

 The equipment has been made for the applications given in the manual. It may not be used for purposes other than those for which it has been designed or differently from those specified in this manual. The various operations must be carried out according to the criteria and the chronology described in this manual.

 Do not disable any safety, notification or warning device and do not ignore any alarm, warning message or notice, no matter whether they are generated automatically or represented by signs fixed to the equipment.

 In case of emergency, follow the regulations in force in the country where the equipment is installed.

2.1 Definitions of “Skilled Technician” and “Operator”

2.1.1 Skilled Technician

The professional that will carry out the installation, start up and ordinary maintenance is called “Skilled Technician”.

This definition refers to people qualified by LEGRAND who have the specific technical qualification and are aware of the method of installing, assembling, repairing, bringing online and using the equipment safely.

In addition to the requirements listed in the paragraph below for a general operator, the Skilled Technician is qualified according to national safety standards to work under dangerous electrical voltage and uses the personal protective equipment required by national safety standards for all the operations indicated in this manual (see the examples listed in paragraph 2.3).

 The safety manager is responsible for protection and company risks prevention according to what is indicated in European directives 2007/30/EC and 89/391/EEC regarding safety in the workplace. The safety manager must ensure that all the people working on the equipment have received all the instructions concerning them in the manual, especially those contained in this chapter.

2.1.2 Operator

The professional assigned to the equipment for normal use is called "Operator".

This definition refers to people who know how to operate the equipment defined in the user manual and have the following requisites:

1. technical education, which enables them to operate according to safety standards in relation to the dangers linked to the presence of electric current.
2. training on the use of personal protective equipment and basic first aid interventions.

When choosing an operator, the company safety manager must consider

- the person's work fitness according to the laws in force.
- the physical aspect (not disabled in any way).
- the psychological aspect (mental stability, sense of responsibility).
- the educational background, training and experience.
- the knowledge of the standards, regulations and measures for accident prevention.

He shall also provide training in such a way as to provide thorough knowledge of the equipment and its component parts.

Some typical activities the operator is expected to carry out are:

- the use of the equipment in its normal functioning state and the restore of the functioning after it shuts down.
- the adoption of the necessary provisions for maintaining the quality performance of the UPS.
- the cleaning the equipment.
- cooperation with personnel responsible for ordinary maintenance activities (Skilled Technicians).

2.2 Personal Protective Equipment



The UPS poses a considerable risk of electric shocks and a high short circuit current. During installation, use and maintenance operations, the equipment mentioned in this section must be used.



People responsible for operating this equipment and/or passing close to it must not wear garments with flowing sleeves, nor may laces, belts, bracelets or other metal pieces that might cause a danger.

The following list sum up the minimum Personal Protective Equipment to wear always. Additional requirements may be needed according to national safety standards.



Anti-accident and non-sparking shoes with rubber sole and reinforced toe



Protective gloves for handling operations



Isolated rubber gloves for operations of connection and work under hazardous voltage



Protective garments for electrical work



Protective face and head shield



Isolated tools



The skilled technician must work on electrical insulated carpet, and he must not wear any kind of metal objects like watches, bracelets, etc.

2.3 Hazard signs in the workplace

The following signs must be exhibited at all points of access to the room where the equipment is installed:



Electric current
This sign indicates electrical live parts.



How to proceed in an emergency
Do not use water to quench fires but only extinguishers designed for putting out fires in electrical equipment.



No smoking
This sign indicates that smoking is not allowed.

2.4 Signs on the equipment

Safety signs are displayed on the UPS to communicate warning message about potential dangers. Strictly comply with those instructions. Removing these signs and/or working by ignoring those warnings is prohibited.

Contact the Manufacturer if a sign deteriorates and/or it is no longer legible, even if only partially.



Potential risks can be drastically reduced by wearing the Personal Protective Equipment listed in this chapter, which are indispensable. Always operate with due care around dangerous areas marked by the appropriate warning notices on the equipment.

2.5 Batteries



The UPS is powered by its own DC energy source (batteries). The output terminals may have a dangerous voltage even if the UPS is not connected to the AC power network.

Disconnect all external battery cabinets before performing any installation and/or maintenance operation.



A battery can present a risk of electrical shock and burns by high short-circuit circuit current. Failed batteries can reach temperatures that exceed the burn thresholds for touchable surfaces. The following precautions should be observed when working on batteries:

- a) remove watches, rings or other metal objects.
- b) use tools with insulated handles.
- c) wear rubber gloves and boots.
- d) do not lay tools or metal parts on top of batteries.
- e) disconnect the charging source prior to connecting or disconnecting battery terminals.
- f) determine if battery is inadvertently grounded. If inadvertently grounded, remove source from ground. Contact with any part of a grounded battery can result in electrical shock. The likelihood of such shock can be reduced if such grounds are removed during installation and maintenance (applicable to equipment and remote battery supplies not having a grounded supply circuit).
- g) never leave live cable terminals without an insulated protection.
- h) When replacing batteries, replace with the same type and number of batteries or battery packs. There is the risk of explosion if batteries are replaced by an incorrect type.

Do not dispose of batteries in a fire. The batteries may explode.

Do not open or mutilate batteries. Released electrolyte is harmful to the skin and eyes. It may be toxic. The batteries installed inside the cabinet must be disposed of correctly. For the disposal requirements refer to local laws and relevant standards.



The UPS must not be turned on if liquid is leaking from the batteries.



Do not open any battery breaker while the UPS is powering the loads in stored energy mode.

2.6 Installation and maintenance



Any installation or maintenance operation must be done only after the equipment has been disconnected from any source of power. Check there is no live voltage.

All remote switch disconnectors must be locked with an appropriate padlock to make sure no one will turn them on.



The UPS has a high leakage current. The earthing of the UPS is mandatory. Check that the earthing has been carried out in compliance with IEC (International Electrotechnical Commission) standards or local regulations.

 The UPS functions with TN and TT systems. The output neutral status is the same as the input neutral status.

When the output load needs a different neutral status, it is necessary to place downstream of the UPS a suitably scaled isolation transformer that must be protected in compliance with the standards in force.



To reduce the risk of fire or electric shock, the UPS must work in closed, clean environments with controlled temperature and humidity. It must be kept away from water and any inflammable liquids and corrosive substances. The room temperature must not be above +40°C (+104°F) and the relative humidity must be a maximum of 95% not condensing.



Do not run the equipment with fixed protections not installed (panels etc.). In case of breaking, buckling or malfunctioning of the equipment or parts of it, repair or replace immediately.





The equipment and workplace must be kept completely clean. Do not use oils or chemical products for cleaning because they could scratch, corrode or damage certain parts of the equipment. Upon completion of the installation/maintenance operations, before connecting the power supply, carefully check that no tools and/or material of any kind have been left next to the equipment. Depositing flammable material near the equipment is forbidden.



Do not plug non-computer-related items such as medical, life-support and house electric equipment.

 Ensure that the cables connecting the loads to the UPS are not longer than 10 meters. Use the output cables provided by the manufacturer.

 Do not place the UPS near equipment that generate strong electromagnetic fields and/or near equipment that are sensible to electromagnetic fields.

 While maintenance operations are being carried out, "Maintenance work in progress" signs must be affixed in the department in such a way that they can be easily seen from any access area.

 The skilled technician must not leave at the disposal of the operator the installation and maintenance manual and the keys for opening the rack cabinet where the UPS is installed.

 Do not plug laser printers to the UPS output because they have a high start-up current.



Do not attach a power strip or surge suppressor to the UPS to avoid potential overloads.

2.7 Cybersecurity



Physical security is essential to ensure the security of assets supplied by the UPS. The UPS must be installed in a restricted access area with access control and surveillance.



Only limited authorized personnel should be given access to the area where the UPS is installed.



The UPS is designed to be connected and share data via a network interface through the optional SNMP card, which should be connected to a secure network. It is the customer sole responsibility to provide and continuously ensure a secure connection between the equipment and any network and to establish and maintain appropriate measures to protect the UPS, the network and the whole system against any kind of security breaches, unauthorized access, interference, intrusion, leakage or theft of data.



LEGRAND is not liable for damages or losses related to security breaches, unauthorized access, interference, intrusion, leakage or theft of data.

The customer is responsible to have periodical checks to ensure the system functionality and the security measures implemented have not been compromised.

3. Equipment check and transportation

3.1 Visual check

Carefully inspect the packaging and the equipment for any damage that might have occurred during transport.

If there is possible or ascertained damage, immediately inform:

- the transporter and the shipping company.
- the LEGRAND Technical Support Service.

Check that the equipment corresponds with the items indicated in the delivery documentation.

If the UPS must be stored, follow the instructions of chapter 7.



Mechanical damage to the electrical components constitutes a danger to persons and property. In case of doubt regarding the non-integrity of the package or of the product contained therein, contact the manufacturer before carrying out the installation and/or the start-up.

3.2 Equipment check

The equipment and the relative supplied accessories must be in perfect conditions.

Check that:

- the shipping data (address of the recipient, no. of packages, order no, etc.) correspond to what is contained in the delivery documentation.
- the technical rating plate data on the label applied to the UPS correspond with the material described in the delivery documentation.
- the documentation accompanying the equipment includes the installation manual.

In case of discrepancy, immediately inform the LEGRAND Technical Support Service before commissioning the equipment.

The content of the supply is subject to thorough checking before the shipment. Nonetheless it is always advisable to check that it is complete and in order on receiving the material.

The following list is general:

- UPS.
- installation and maintenance manual.
- USB cable.
- accessory kit:

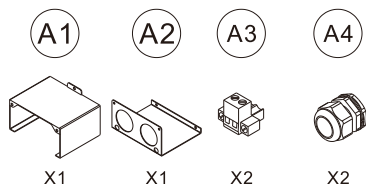
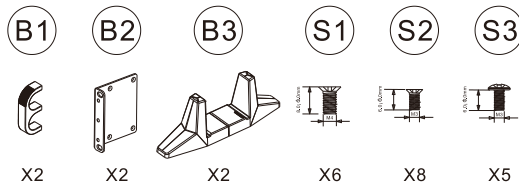

- input/output terminal blocks:

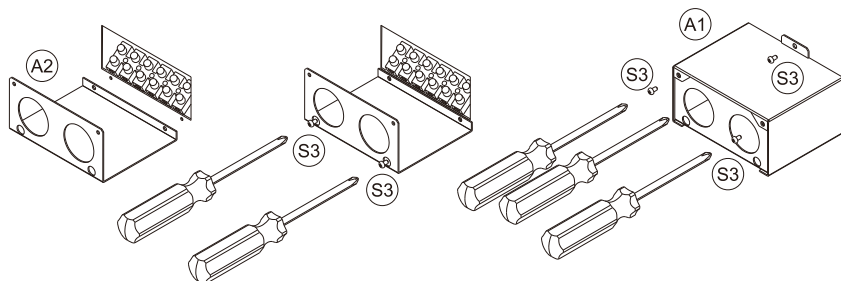

 In case of defects and/or missing items, immediately inform the LEGRAND Technical Support Service before commissioning the equipment.

3.3 Transportation



Avoid turnover during the transport of the UPS. Cabinets must always be handled in upright position. During loading and unloading operations, always respect the indications marked on the package.



Avoid bending or deforming the components and altering the insulation distances while transporting and handling the product.



Do not ship the equipment along with any inflammable, explosive, corrosive item. Do not expose the package to rain or other adverse climatic conditions.



The equipment must always be handled by trained and instructed personnel. Comply with the safety regulations in force in your country relative to the usage of lifting equipment and/or accessories.

3.4 Positioning constraints

Keep good ventilation around the UPS. The clearance between any adjacent devices or wall should be at least 200 mm. Poor ventilation can reduce the service life of inner components and affect the life span of the UPS. Ensure that the air vents on UPS are not blocked.

Since the UPS is heavy, it must be installed in a location that can support its weight.

4. Installation

i All UPS installation operations must be carried out exclusively by a **SKILLED TECHNICIAN** qualified and authorized by **LEGRAND** (paragraph 2.2.1).



Check that the electrical system has been fitted with the necessary differential and thermal-magnetic protections upstream of the UPS.



Check that the mains input voltage and frequency correspond with the values indicated in the technical data on the UPS rating plate.

i The energy quality of the electrical network should comply with the individual voltage harmonics compatibility levels defined by IEC 61000-2-2. For more severe conditions, a power quality audit is required during the UPS commissioning by the **LEGRAND** Technical Support Service to check the compatibility.

i The UPS is equipped with an auto-restart system. In case of return of the input mains after the end of battery operation, the UPS turns on to normal operation by supplying the output loads.

i The UPS is equipped with an automatic backfeed protection system.

4.1 Views

4.1.1 Rear Panel

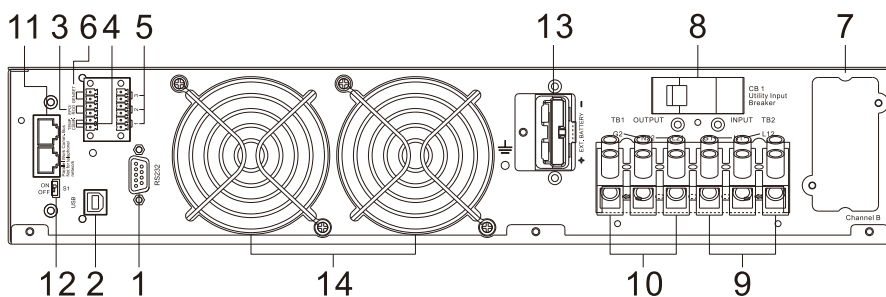

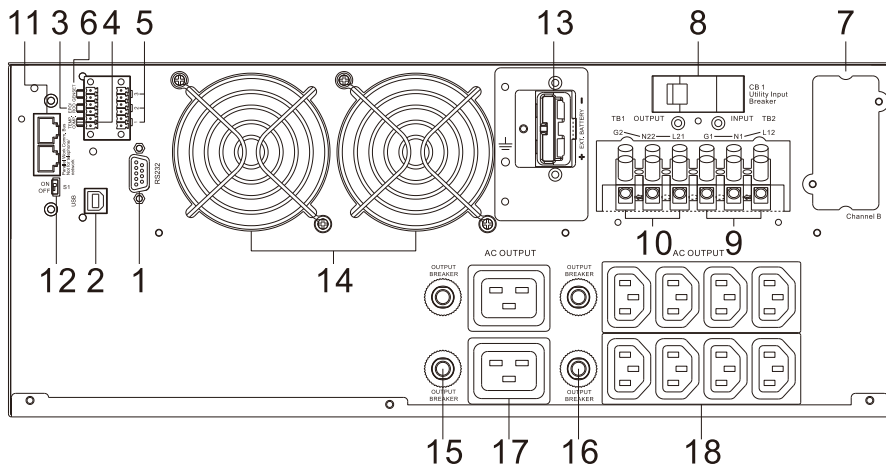

1. RS-232 port
2. USB port
3. Emergency Power Off (EPO) / Remote ON/OFF (ROO)
4. Temp. Comp.
5. 3 Dry contact output port
6. Genset
7. Customer Options Slot (CHB)
8. Utility/Bypass input circuit breaker
9. Input terminal block
10. Output terminal block
11. CAN Bus Connection Port for Parallel System (Do not for telecommunication network) (Optional)
12. Terminal Resistor for Parallel function (Optional)
13. External Battery connector
14. Fan
15. AC Output Breaker for IEC60320 C19 Output Sockets 16A
16. AC Output Breaker for IEC60320 C13 Output Sockets 10A
17. IEC60320 C19 Output Sockets 16A
18. IEC60320 C13 Output Sockets 10A

4.1.2 Operation Panel

Touch Panel Button		
Symbol	Behavior	Description
	Long Press	UPS ON when UPS in AC standby mode
		UPS OFF when UPS in running mode
	Long Press Twice	UPS ON when UPS in DC standby mode
	Short Press	Alarm Silence



Touch Panel Display	
Sign	Description
	Home Page-UPS Flow Chart
	Measurement Page-UPS Measurement Parameter
	Setting Page-UPS Setting Parameter
	Control Page-UPS Command Function
	Miscellaneous Page-UPS Information
 (Left Side)	Utility Power Status
	Genset Function
	Rectifier/Booster Operating Status

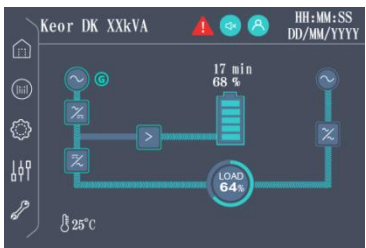

	Battery Charging Status
	Battery Discharging Status
	Inverter Switch Operating Status
 (Right Side)	Bypass Power Status
	Bypass Switch Operating Status
	UPS Fault or Abnormal Warning
	Buzzer Silent
	Account Login Status
	Date & Time (HH:MM:SS DD/MM/YYYY)
	UPS Model Name
	Ambient Temperature
	Battery Capacity Level & Remaining runtime
	Load level

4.2 Mechanical Installation

4.2.1 Tower installation

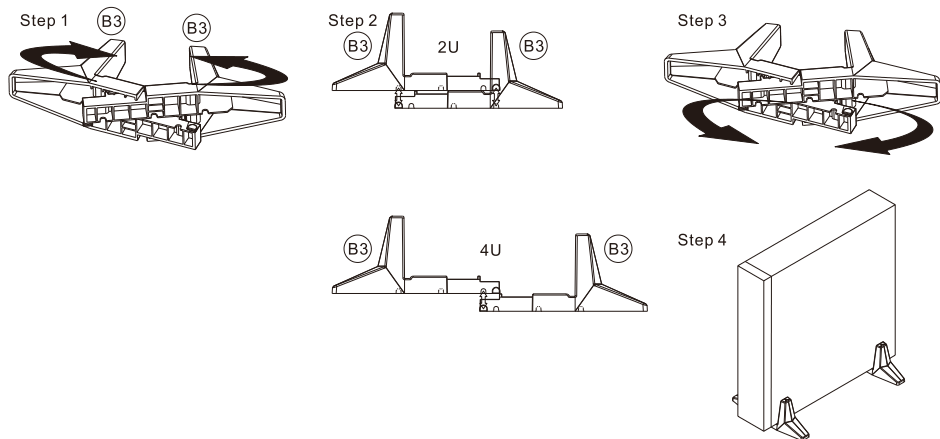

4.2.2 Rack mount installation

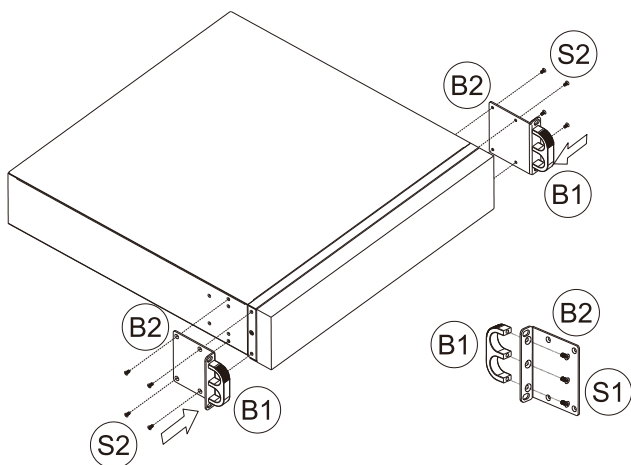

i The UPS must be installed always at the top of other equipment like battery cabinets.



Do not transport the UPS or the battery cabinet by handles.



The battery cabinet is heavy, so it must be installed from bottom to top of the rack cabinet and located below the UPS.

4.3 Electrical connection

The electrical connection is part of the work that is not performed by LEGRAND, and it is the sole responsibility of the Skilled Technician. Therefore, the following recommendations are only an indication, and it is recommended that the electrical installation is carried out in compliance with local and national standards.



Cables must be selected bearing in mind technical, financial and safety aspects. The selection and the sizing of cables from a technical viewpoint depend on the voltage, current, ambient temperature, voltage drop and cable laying.

The cables used for the installation must have a maximum operating temperature of at least 75°C.

For more explanations regarding the selection and the sizing of cables, refer to relevant IEC standards like IEC 60364.

The mains input and bypass input must use the same neutral wire.

Check chapter 9 and 10 for all the technical data.

4.3.1 Protection from overloads and short-circuits

Short-circuit currents (very high currents with a short duration) and overload currents (relatively high currents with a long duration) are among the main causes of cable damage. The protection systems normally used to protect the cables are thermal magnetic circuit breakers or fuses.

Protection circuit breakers must be selected according to the maximum short-circuit current (max I_{sc}) that is needed to determine the breaking power of automatic circuit breakers, and to the minimum current (min I_{sc}) that is needed to determine the maximum length of the line protected. The protection against short-circuit must operate on the line before any thermal and electrothermal effects of the overcurrent may damage the cable and relevant connections.



This product can cause a d.c. current in the PE conductor. Where a residual current-operated protective device (RCD) is used for protection against electrical shock, only an RCD of Type A is allowed on the supply side of the UPS.

4.3.2 Wiring operation

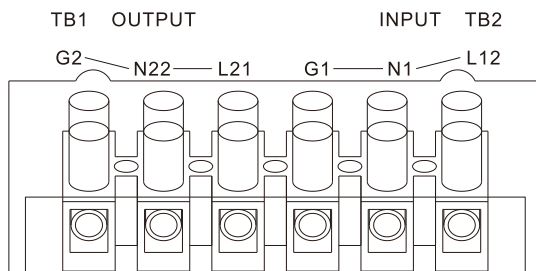

L12-N1: Input terminals
 G1: Input Ground terminal
 L21- N22: Output terminals
 G2: Output Ground terminal

4.3.2.1 5kVA and 6kVA unit with battery cabinet

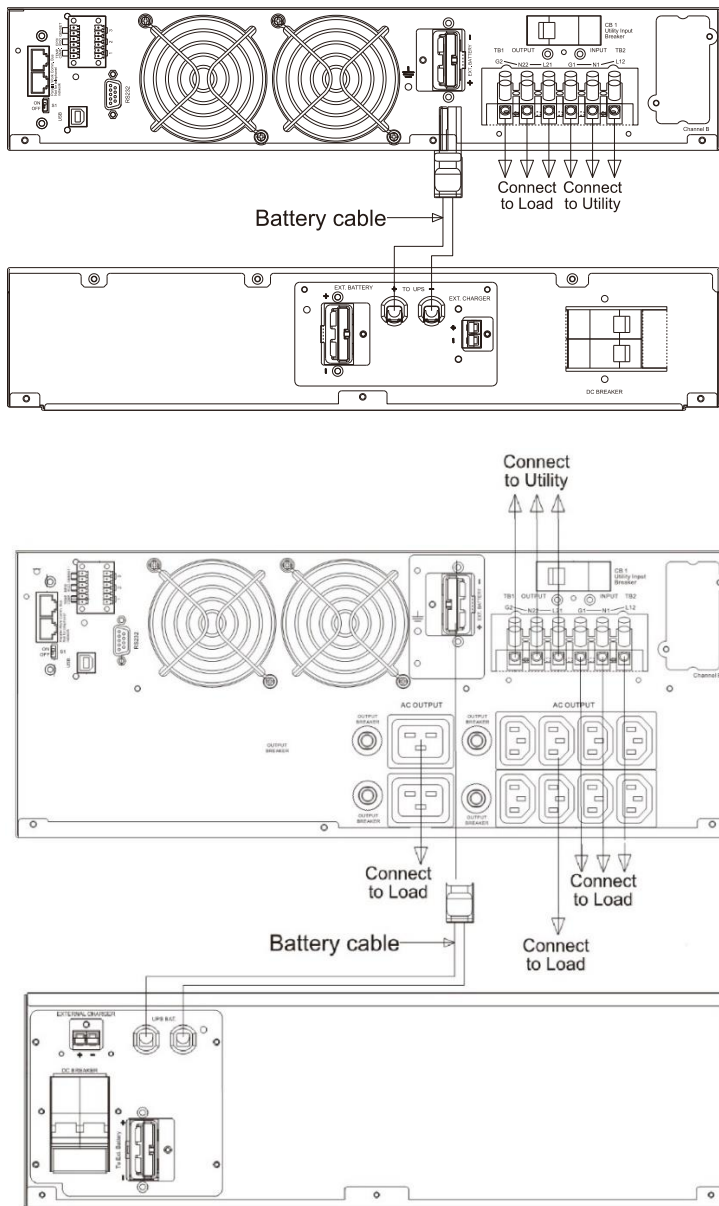

4.3.2.2 10kVA unit with battery cabinet

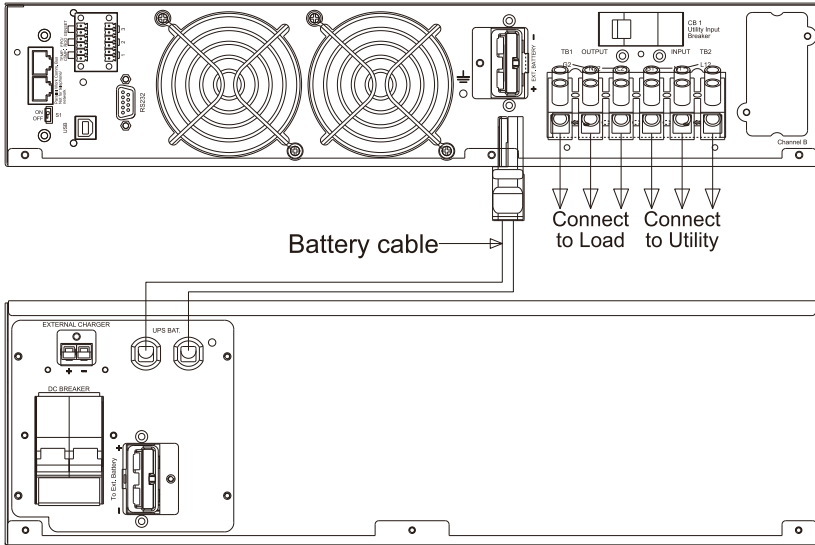

4.4 Communication

The UPS is equipped with aRS-232 communication port for remote monitoring of the UPS status using a PC.

It is possible to use optional interfaces cards for R2E (RS-232), RSE (RS-485), USE (second USB) and SNMP. However, the R2E card, RSE card and USE card must not be used simultaneously.

When the optional interface cards are used together with the onboard USB port, the EPO signals will get highest priority, then the SNMP/WEB card, then the shutdown command at the DCE, R2E, RSE, and USE cards, and then finally the onboard USB port gets the lowest priority.

4.4.1 RS232

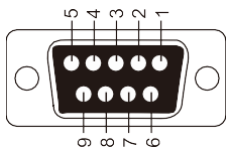

Pin 3: RS-232 Rx
Pin 2: RS-232 Tx
Pin 5: Ground

Baud Rate	9600 bps
Data Length	8 bits
Stop Bit	1
Parity	None

4.4.2 USB

The USB communication protocol complies with USB version 1.0, 1.5 Mbps and USB HID version 1.0.

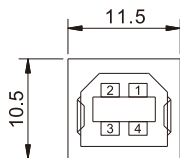

1 → VCC (+5V)
2 → D-
3 → D+
4 → Ground

4.4.3 EPO and input dry contacts

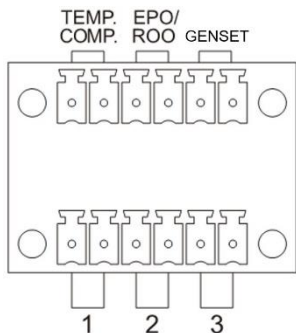

Item	Function	Description
1	Dry Contact 1 NO (default) / NC	Active when UPS fault event occurs
2	Dry Contact 2 NO (default) / NC	Active when battery low event occurs
3	Dry Contact 3 NO (default) / NC	Active when UPS on battery event occurs
TEMP. COMP.	Temperature Compensation	Auto-sensing external temperature of battery bank to adjust charger voltage
	EPO NO (default)	Shutdown UPS
EPO NC		
ROO NO		
EPO/ ROO	ROO NC	Start-up UPS
	GENSET NO (default)	Set charger to minimum charge current
GENSET NC		

The functions can be set through setting tool SW.

5. Configuration and starting-up



All configurations and start-up operations must be carried out exclusively by a **SKILLED TECHNICIAN** (paragraph 2.2.1).

5.1 Pre-start-up checks

Before powering the equipment, carry out the following checks:

1. Check that the mains, output, and battery disconnectors are open (OFF position).
2. Check that all wiring has been done and that all connections have been tightened up properly.
3. Check if the installation and wiring are good for transformation, expansion and maintenance in future.
5. Check if the voltage between the neutral wire and grounding wire is less than 5Vac.
6. Check that there is no short-circuit in the output of the UPS and the load capacity isn't beyond the rated capacity of the UPS.
7. Check that the EPO ports is properly configured and connected.

5.2 Start-up procedure

1. Turn on the external mains, and battery disconnectors.



It is also possible to turn on the UPS in battery mode (cold start) if the mains is not available.

2. Turn on the input breaker CB1
3. The UPS will enter into standby mode after the initializing procedure is finished and the fan will start to spin
4. Tap the *Login* icon on the top 
5. The default installer username and password is "instal" and "222222". The default user username and password is "user" and "1111111".









The skilled technician must change the default password for the installer

6. If you want to change any setting, see paragraph 5.3
7. Press  key and hold it until a twice beep is heard. Then, release the button. The UPS begins the starting procedures, and the buzzer will beep intermittently. The start-up procedure takes approximately 1 minute.



The UPS is equipped with an auto-restart system. In case of return of the input mains after the end of battery operation, the UPS turns on to normal operation by supplying the output loads.

5.3 UPS Default Data and Special Function Execution

1. After the UPS completely wake up (standby mode), press  on screen of the touch panel.
2. Press  or  to change the other setting page
3. Press  to change setting value.
4. Press  to save settings.
5. Press  to quit setting mode.

6. Maintenance



INSTALLATION and ORDINARY MAINTENANCE operations must be carried out only by SKILLED TECHNICIANS (paragraph 2.2.1). EXTRAORDINARY MAINTENANCE operations must be carried out only by LEGRAND TECHNICAL SUPPORT SERVICE.

LEGRAND declines all liability for any injury or damage caused by activities carried out differently from the instructions written in this manual.



Keep a register in which to enter the date, time, type and any other useful information about any routine and extraordinary maintenance operation.

6.1 Preventive maintenance

The UPS does not contain parts for preventative maintenance by the operator.

The operator must regularly perform:

- a general external cleaning.
- a check to verify there is no alarm indication on the display.
- a check to verify the correct functioning of the ventilating fans.

6.2 Periodical checks

The correct functioning of the UPS must be guaranteed by periodical maintenance inspections. These are essential to safeguard the reliability of the equipment.

These inspections should also be made to determine if components, wiring, and connections exhibit evidence of overheating.

During a maintenance inspection, the skilled technician must carry out the following checks:

- no alarm presence.
- list of the memorised events.
- correct function of the static and maintenance bypass.
- integrity of the electrical installation.
- flow of cold air.
- battery status.
- characteristics of the applied load.
- conditions of the installation location.

Contact the LEGRAND Technical Support Service in case of problems.



The periodical checks involve operations inside the UPS in presence of dangerous voltages. Only maintenance personnel trained by LEGRAND are authorized to intervene.



6.3 Ordinary and extraordinary maintenance

Contact the LEGRAND Technical Support Service if there are failures that require the access to internal parts of the UPS.

6.4 Troubleshooting

If UPS is in abnormal condition, a common alarm sign  will light up with and audible alarm.

6.4.1 Common faults

Fault	Error Code	Possible reason
Red Fault LED/Alarm Icon	Er05	Check for proper battery connection, then recharge the batteries for 8 hours to see whether the UPS provides backup power normally
	Er06, Er10, Er12, Er28 & overload icon	If CB3 is tripped, turn off the UPS completely and keep the CAM switch at position 'INV' before pressing CB3. Then remove some uncritical load at the UPS output end. If there is any damage to the insulation of the AC power cord, please replace it with a new one.
	EPO	The Emergency Power Off was activated
	Er11, Er33	Remove any objects blocking the ventilation holes
	Er14	Check that the cooling fans on the rear panel are working normally. Make sure the UPS is operating normally. If it is in CVCF mode, you must turn off and turn on the UPS again.
	Er15	Check CAM switch turn to 'INV' position.
	Er16, Er17, Er27	All parameters except ID Number in a parallel UPS must be the same
	Er21	Disconnect and reconnect the RJ45 connector or set a UPS with ID=1.
	Er24	When the UPS is in CVCF mode it is prohibited from having bypass input. You must turn off the UPS and bypass input and then restart the UPS.
	Other error code	Contact the LEGRAND Technical Support Service
UPS fails to offer battery backup or its backup power time is shorter than the one expected		If the backup power time is still too short after 8 hours of charging, contact the LEGRAND Technical Support Service
UPS locks itself and cannot be turned off		<ol style="list-style-type: none"> 1) press  icon to show the Error event. Check and record the error code. 2) Check the manual to understand the possible cause and solve the problem. If it is not clear, contact the LEGRAND Technical Support Service. 3) Press  key and hold it for 5 seconds until a twice beep is heard. 4) Turn OFF the mains disconnector 5) After the UPS is completely shut off, the UPS is unlocked.

6.4.2 Error codes

Code	Meaning
EPO	Emergency Power Off
Er05	Battery Weak or Dead
Er06	Output Short Circuit
Er10	Inverter Over-current
Er11	The UPS is overheated
Er12	UPS Output Overloading
Er14	Fan Error
Er15	Wrong Procedure to Enter Maintenance Mode
Er16	Output Parameters Set Error in Parallel System
Er17	ID Numbers are in conflict in Parallel System or ID number error in single unit
Er21	Parallel communication error (communication wire disconnected or failure to find ID1 UPS) in Parallel System
Er24	CVCF mode with Bypass input
Er27	The UPS must be operated in normal mode in Parallel System.
Er28	Bypass Overload Time out and cut off output
Er33	Isolated transformer is overheated.
Er**	Other Error code

**The specified modes include Normal mode, ECO mode, CVCF mode, etc.

6.4.3 Beep codes

UPS Status	Beep code
UPS faulty, Inverter shut down. All functions inhibited.	Long continuous beep
Control keypad error	Long continuous beep
UPS faulty, loads continue to be supplied via Inverter or Bypass.	Single beep every two seconds
In battery mode	Thrice quick and short beeps per 10 second
Battery low	Quick and short successive beeps
Confirm RS-232 or USB port receiving	Two quick and short beeps
Service mode okay	One quick and short beep

7. Warehousing



All storage operations must be carried out only by a **SKILLED TECHNICIAN** (paragraph 2.2.1)



A SKILLED TECHNICIAN must check that there is no voltage present before disconnecting the cables.

7.1 UPS

The UPS must be stored in an environment with a room temperature between -20°C (-4°F) and $+50^{\circ}\text{C}$ ($+122^{\circ}\text{F}$) and humidity less than 95% (not condensing).

The package box must be raised off the ground by at least 200 mm and kept at a distance of at least 500 mm from wall, heat source, cold source, window or air inlets.

In the warehouse, any inflammable, explosive, corrosive object or harmful gas is not allowed. The environment must also be free from strong mechanical shakes, impacts or magnetic fields.

7.2 Batteries

It is possible to store batteries without recharging them in the following conditions:

- up to 6 months if the temperature is between $+20^{\circ}\text{C}$ ($+68^{\circ}\text{F}$) and $+30^{\circ}\text{C}$ ($+86^{\circ}\text{F}$).
- up to 3 months if the temperature is between $+30^{\circ}\text{C}$ ($+86^{\circ}\text{F}$) and $+40^{\circ}\text{C}$ ($+104^{\circ}\text{F}$).
- up to 2 months if the temperature is over $+40^{\circ}\text{C}$ ($+104^{\circ}\text{F}$).



Batteries must never be stored if partially or totally discharged.

LEGRAND is not liable for any damage or bad functioning caused to the UPS by wrong warehousing of the batteries.

8. Dismantling



Dismantling and disposal operations must be carried out only by a **SKILLED TECHNICIAN** (paragraph 2.2.1).

The instructions in this chapter are to be considered indicative: in every country there are different regulations regarding the disposal of electronic or hazardous waste such as batteries. It is necessary to strictly adhere to the regulations in force in the country where the equipment is used.

Do not throw any component of the equipment in the ordinary rubbish.

8.1 Battery disposal

Batteries must be disposed of in a site intended for the recovery of toxic waste. Disposal in the traditional rubbish is not allowed. Apply to the competent agencies in your countries for the proper procedure.



Pb



A battery may constitute a risk of electric shock and high short-circuit current. When working on batteries, the prescriptions indicated in chapter 2 must be adhered to.

8.2 UPS dismantling

The dismantling of the UPS must occur after the dismantling of the various parts it consists of. For the dismantling operations, it is necessary to wear the Personal Protective Equipment mentioned in paragraph 2.3.

Sub-divide the components separating the metal from the plastic, from the copper and so on according to the type of selective waste disposal in the country where the equipment is dismantled.

If the dismantled components must be stored before their disposal, be careful to keep them in a safe place protected from atmospheric agents to avoid soil and groundwater contamination.

8.3 Electronic component dismantling

For the disposal of electronic waste, it is necessary to refer to the relevant standards.



This symbol indicates that in order to prevent any negative effects on the environment and on people, this product should be disposed of separately from other household waste, by taking it to authorised collection centres, in accordance with the EU countries local waste disposal legislations. Disposing of the product without following local regulations may be punished by law. It is recommended to check that this equipment subject to WEEE legislations in the country where it is used.

9. Technical characteristics

MAIN FEATURES

	5 kVA 3 113 48 3 113 50	6 kVA 3 113 49 3 113 51	10 kVA 3 113 52
Nominal Power (kVA)	5	6	10
Active Power (kW)	5	6	10
Output Power Factor	1		
Technology	Online, double conversion VFI-SS-11 (EN IEC 62040-3)		
IN/OUT configuration	Single-phase / Single-phase		
Functions available	Frequency converter ECO mode for energy saving Parallel function Generator compatible (Cold start in stored energy mode)		
Neutral system	Neutral passing through		
Bypass	Automatic (static) External Manual (optional)		
Overvoltage category	OVC II		
Protection class (EN/IEC 61140)	I		
AC power distribution system compatibility	TN, TT		

INPUT ELECTRICAL CHARACTERISTICS

	5 kVA	6 kVA	10 kVA
	3 113 48 3 113 50	3 113 49 3 113 51	3 113 52
Maximum Input current (A)	27.5	33	56
Input voltage (V)	230		
Input voltage range (V)	176 to 280 (full load)		
Input frequency (Hz)	50/60 (with autosensing)		
Input frequency range	± 5 Hz (Normal mode) 40 – 70 (CVCF mode)		
Input Power Factor	≥ 0.99		
Total harmonic distortion of the input current	THDi ≤ 5%		
I _{sc} Prospective short-circuit current (kA)	10		

OUTPUT ELECTRICAL CHARACTERISTICS

	5 kVA 3 113 48 3 113 50	6 kVA 3 113 49 3 113 51	10 kVA 3 113 52
Output current(A)	22.7	27.3	45.5
Output voltage (V)	200/208/220/230/240 (default 230) (200/208 with derating 80%)		
Output voltage range	± 1%		
Output frequency (Hz)	50 / 60 (selectable by the user, default 50)		
Output frequency range (Hz)	if not synchronized (free run): ± 0.1		
Crest factor admitted on the output current	3:1		
Total harmonic distortion of the output voltage	THDv ≤ 2%		
Efficiency in Normal Mode (%)	up to 95.1	up to 96	
Efficiency in Eco Mode (%)	up to 99		
Overload capacity	<p>Normal mode ≤105% continuous 106-125% for 10 min ~ 30 sec, then transfer to Bypass 125-150% for 30 sec~ 0.16 sec, then transfer to Bypass > 150% 0.16 sec, then transfer to Bypass</p> <p>Stored energy mode ≤105% continuous 106-125% for 10 min~ 30 sec, then transfer to Bypass or shutdown 125-150% for 30 sec~ 0.16 sec, then transfer to Bypass or shutdown > 150% 0.16 sec, then transfer to Bypass or shutdown</p> <p>ECO mode ≤105% continuous 106-150% for 10 min ~ 2 sec, then shutdown 150-200% for 2 sec ~ 0.16 sec, then shutdown > 200% 0.16 sec, then shutdown</p>		

BATTERIES AND BATTERY CHARGER CHARACTERISTICS

	5 kVA 3 113 48 3 113 50	6 kVA 3 113 49 3 113 51	10 kVA 3 113 52
Nominal battery voltage (Vdc)	240		
Maximum battery current (A)	30	36	53
Battery type	Maintenance-free Lead-acid, VRLA 12V		
Battery string	20 batteries		
Charging current (A)	up to 4 (adjustable to 1/2/4 by panel or setting software - default 1A)		
Recharge time (1A charge current)	5 h to 90% charge		

MECHANICAL CHARACTERISTICS

	5 kVA 3 113 50	6 kVA 3 113 51	10 kVA 3 113 52
Net weight (kg)	16.2		18.2
Dimensions H x W x D (mm)	88 (2U) x 440 x 700		

	5 kVA 3 113 48	6 kVA 3 113 49
Net weight (kg)	54	
Dimensions H x W x D (mm)	176 (4U) x 440 x 700	

OTHER FEATURES

	5 kVA 3 113 48 3 113 50	6 kVA 3 113 49 3 113 51	10 kVA 3 113 52
Display	4.3" LCD color touchscreen with led bar		
Communication ports	RS232 input dry contacts USB Slot for cards (SNMP, DCE, RS485)		
Protections	Emergency Power Off (EPO) Electronic against overtemperature, overloads, short-circuit and excessive battery discharge Block of functions due to the end of autonomy In-rush limiter on start up Fan speed control according to the load percentage and temperature Internal Backfeed protection		
Remote management	available		

ENVIRONMENTAL CONDITIONS

	5 kVA 3 113 48 3 113 50	6 kVA 3 113 49 3 113 51	10 kVA 3 113 52
Operating temperature (°C)	0 to +40 (The battery life will reduce with a temperature >25 °C)		
Relative humidity during operation (%)	0 to 95 (non-condensing)		
Storage temperature (°C)	-10 to +50 (The battery life will reduce with a temperature >25 °C)		
Noise level at 1 meter (dBA)	≤ 50 45dB on Bypass and Online Mode with ≤70% load		
Ingress Protection Marking	IP 20		
Pollution degree	PD2		
Climatic class (EN IEC 60721-3-3)	3K22		
Special climatic class (EN IEC 60721-3-3)	3Z2		
Biological class (EN IEC 60721-3-3)	3B2		
Mechanical class (EN IEC 60721-3-3)	3M11		
Mechanically active substances class	3S5		

(EN IEC 60721-3-3)	
Operating height	up to 2000 meters above sea level without derating

REFERENCE DIRECTIVES AND STANDARDS

Marks	CE, CMIM, UKCA
Safety	2014/35/EU Directive EN IEC 62040-1
EMC	2014/30/EU Directive EN IEC 62040-2
Performance and test requirements	EN IEC 62040-3

10. Technical data

i LEGRAND is not responsible for the correct sizing of the cables which are specific of each electrical installation (see paragraph 4.4).

TABLE 1
Recommended wire cross-sections for the AC input and output (environment temperature:25°C)

UPS	Maximum Current	Wire-Cross Section
5 kVA	27.5 A	AWG #10 or 6 mm ²
6 kVA	33 A	AWG #10 or 6 mm ²
10 kVA	56 A	AWG #6 or 16 mm ²

TABLE 2
Recommended wire cross-sections for the Battery input (environment temperature:25°C)

UPS	Maximum Current	Wire-Cross Section
5 kVA	30 A	AWG #10 or 6 mm ²
6 kVA	36 A	AWG #10 or 6 mm ²
10 kVA	53 A	AWG #6 or 16 mm ²

i The maximum current for each terminal is 36 A for the 5/6 kVA unit and 56 A for the 10 kVA unit.

i PVC copper wires must be used with an operating temperature of at least 75°C (167°F)

TABLE 3
Residual current breaker recommended for input line

POWER	RESIDUAL CURRENT BREAKER ($I_{\Delta n}$)
5 kVA	30 mA type A
6 kVA	
10 kVA	

LEGRAND
Pro and Consumer Service
BP 30076 - 87002
LIMOGES CEDEX FRANCE
www.legrand.com

Installer stamp