

**Data Sheet | Item Number: 235-405/331-000**

PCB terminal block; push-button; 1.5 mm<sup>2</sup>; Pin spacing 5/5.08 mm; 5-pole; Push-in CAGE CLAMP®; gray

<https://www.wago.com/235-405/331-000>

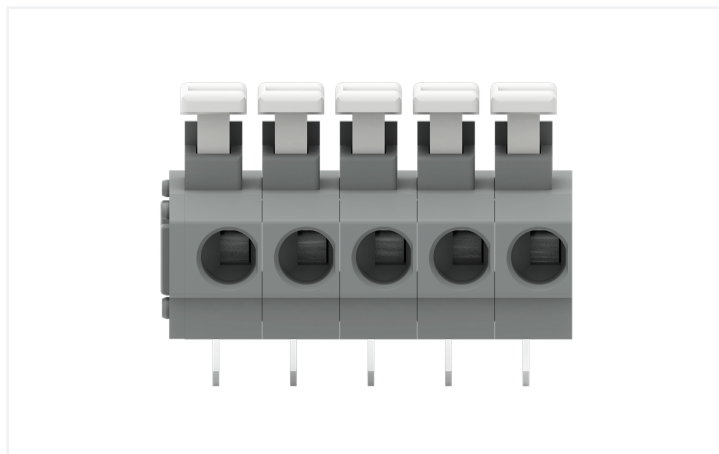
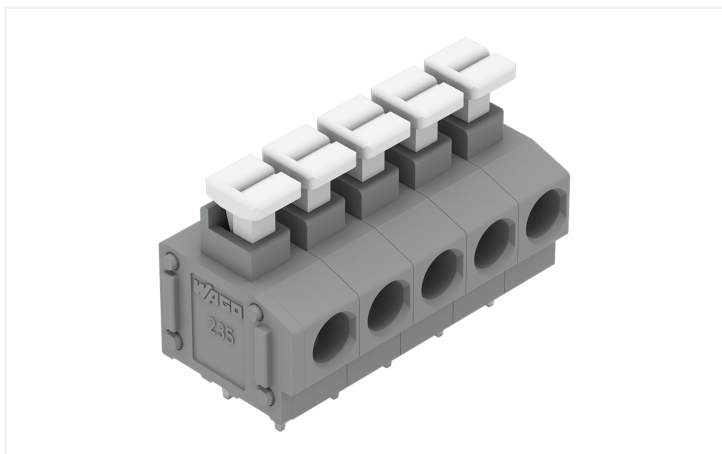

Color: ■ gray

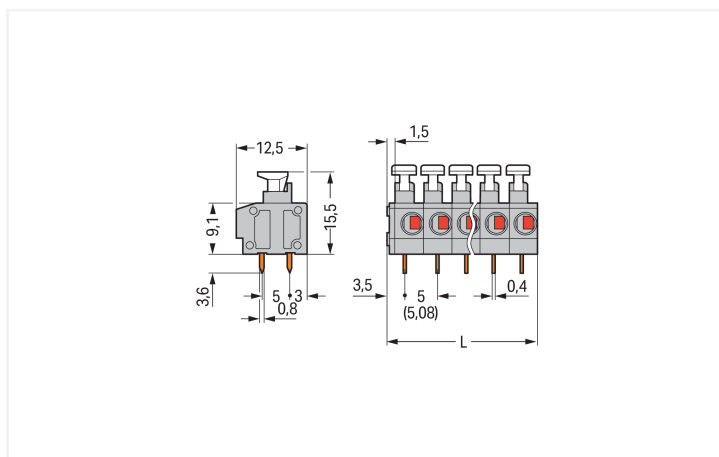
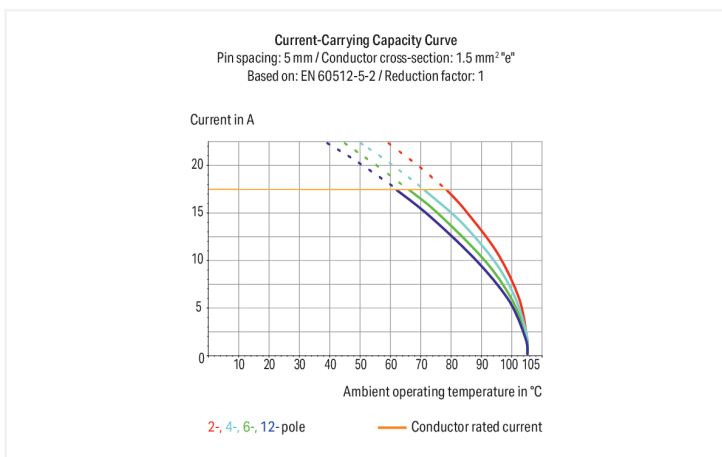
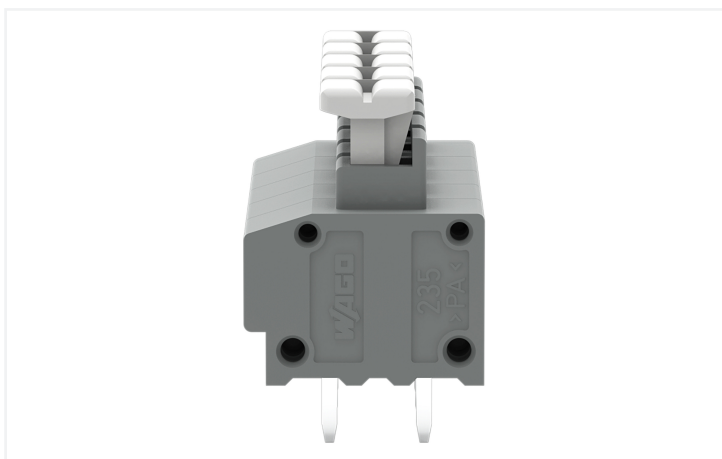

Dimensions in mm  
 L = (pole no. x pin spacing) + 1.5 mm

PCB terminal block, 235 Series, push-button

This PCB terminal block (item number 235-405/331-000) is designed for easy and secure connections. You can rely on trusted safety with these PCB terminal blocks, perfect for a host of applications when designing your devices. Conductors should only be connected to this PCB terminal block if their strip length is between 9 and 10 mm. This product features one conductor terminal and utilizes Push-in CAGE CLAMP®. Push-in CAGE CLAMP® con-

nection technology is ideal for connecting all conductor types. Both solid and fine-stranded conductors with ferrules can be inserted without the need for tools—all thanks to its pluggable design. Dimensions: (26.5 x 19.1 x 12.5) mm (width x height x depth). This PCB terminal block is suitable for conductor cross sections ranging from 0.2 mm<sup>2</sup> to 1.5 mm<sup>2</sup>. The contact surface is coated with tin. A push-button is used to operate this PCB terminal block. The PCB terminal block is designed for THT soldering. The conductor is designed to be inserted at an angle of 0°.

## Notes

Variants:	Other pole numbers Other colors Terminal strips with 7.5/7.62 mm and 10/10.16 mm pin spacing Mixed-color PCB connector strips Direct marking Other versions (or variants) can be requested from WAGO Sales or configured at <a href="https://configurator.wago.com/">https://configurator.wago.com/</a> .
-----------	--

## Electrical data

Ratings per	IEC/EN 60664-1			Approvals per	UL 1059		
Overvoltage category	III	III	II	Use group	B	C	D
Pollution degree	3	2	2	Rated voltage	300 V	-	300 V
Nominal voltage	250 V	320 V	630 V	Rated current	10 A	-	10 A
Rated impulse withstand voltage	4 kV	4 kV	4 kV				
Rated current	17.5 A	17.5 A	17.5 A				

Approvals per	CSA		
Use group	B	C	D
Rated voltage	300 V	-	-
Rated current	15 A	-	-

## Connection Data

Clamping units	5	<b>Connection 1</b>	
Total number of potentials	5	Connection technology	Push-in CAGE CLAMP®
Number of connection types	1	Actuation type	Push-button
Number of levels	1	Solid conductor	0.2 ... 1.5 mm <sup>2</sup> / 20 ... 14 AWG
		Fine-stranded conductor	0.75 ... 1.5 mm <sup>2</sup> / 20 ... 14 AWG
		Fine-stranded conductor; with insulated ferrule	0.25 ... 1 mm <sup>2</sup>
		Fine-stranded conductor; with uninsulated ferrule	0.25 ... 1 mm <sup>2</sup>
		Note (conductor cross-section)	Fine-stranded conductor 0.25 ... 0.5 mm <sup>2</sup> (I max. 2 A) Fine-stranded conductor 0.75 ... 1.5 mm <sup>2</sup> (I max. 6 A)
		Strip length	9 ... 10 mm / 0.35 ... 0.39 inches
		Conductor connection direction to PCB	0°
		Pole number	5

## Physical data

Pin spacing	5/5.08 mm / 0.197/0.2 inches
Width	26.5 mm / 1.043 inches
Height	19.1 mm / 0.752 inches
Height from the surface	15.5 mm / 0.61 inches
Depth	12.5 mm / 0.492 inches
Solder pin length	3.6 mm
Solder pin dimensions	0.4 x 0.8 mm
!	1 (+0.1) mm

### PCB contact

PCB contact	THT
Solder pin arrangement	over the entire terminal strip (in-line)
Number of solder pins per potential	2

### Material data

Note (material data)	<a href="#">Information on material specifications can be found here</a>
Color	gray
Material group	I
Insulation material (main housing)	Polyamide (PA66)
Flammability class per UL94	V0
Clamping spring material	Chrome-nickel spring steel (CrNi)
Contact material	Electrolytic copper (E <sub>Cu</sub> )
Contact Plating	Tin
Fire load	0.074 MJ
Weight	3.7 g

### Environmental requirements

Limit temperature range	-60 ... +105 °C
-------------------------	-----------------

### Commercial data

Product Group	4 (Printed Circuit Connectors)
PU (SPU)	180 (45) pcs
Packaging type	Box
Country of origin	CN
GTIN	4055143258753
Customs tariff number	85369010000

### Product Classification

UNSPSC	39121409
eCl@ss 10.0	27-44-04-01
eCl@ss 9.0	27-44-04-01
ETIM 9.0	EC002643
ETIM 10.0	EC002643
ECCN	NO US CLASSIFICATION

### Environmental Product Compliance

RoHS Compliance Status	Compliant, No Exemption
------------------------	-------------------------

### Approvals / Certificates

#### General approvals



#### General approvals

KEMA/KEUR DEKRA Certification B.V.	EN 60947	2160584.38
---------------------------------------	----------	------------

Approval	Standard	Certificate Name
CCA DEKRA Certification B.V.	EN 60947	NTR NL-7144
CCA DEKRA Certification B.V.	EN 60998	NTR NL 6919
CSA DEKRA Certification B.V.	C22.2	1673956

Declarations of conformity and manufacturer's declarations

Approval	Standard	Certificate Name
EU-Declaration of Conformity WAGO GmbH & Co. KG	-	-
UK-Declaration of Conformity WAGO GmbH & Co. KG	-	-

Approvals for marine applications



Approval	Standard	Certificate Name
ABS American Bureau of Shipping	-	24-0095975-PDA
DNV DNV GL SE	-	TAE000016Z
PRS Polski Rejestr Statków	-	TE/1095/880590/23

Downloads

Environmental Product Compliance

Compliance Search	
Environmental Product Compliance 235-405/331-000	<a href="#">↓</a>

Documentation

Additional Information			
Technical Section	03.04.2019	pdf 2027.26 KB	<a href="#">↓</a>

CAD/CAE-Data

CAD data	
2D/3D Models 235-405/331-000	<a href="#">↓</a>

CAE data	
EPLAN Data Portal 235-405/331-000	<a href="#">↓</a>
ZUKEN Portal 235-405/331-000	<a href="#">↓</a>

PCB Design

Symbol and Footprint via SamacSys 235-405/331-000	<a href="#">↓</a>
Symbol and Footprint via Ultra Librarian 235-405/331-000	<a href="#">↓</a>

**1 Compatible Products**

**1.1 Optional Accessories**

**1.1.1 Ferrule**

**1.1.1.1 Ferrule**



**Item No.: 216-241**  
 Ferrule; Sleeve for 0.5 mm<sup>2</sup> / 20 AWG; insulated; electro-tin plated; electrolytic copper; gastight crimped; acc. to DIN 46228, Part 4/09.90; white



**Item No.: 216-141**  
 Ferrule; Sleeve for 0.5 mm<sup>2</sup> / 20 AWG; un-insulated; electro-tin plated; electrolytic copper; gastight crimped; acc. to DIN 46228, Part 1/08.92



**Item No.: 216-242**  
 Ferrule; Sleeve for 0.75 mm<sup>2</sup> / 18 AWG; insulated; electro-tin plated; electrolytic copper; gastight crimped; acc. to DIN 46228, Part 4/09.90; gray



**Item No.: 216-262**  
 Ferrule; Sleeve for 0.75 mm<sup>2</sup> / 18 AWG; insulated; electro-tin plated; electrolytic copper; gastight crimped; acc. to DIN 46228, Part 4/09.90; gray



**Item No.: 216-142**  
 Ferrule; Sleeve for 0.75 mm<sup>2</sup> / 18 AWG; uninsulated; electro-tin plated; electrolytic copper; gastight crimped; acc. to DIN 46228, Part 1/08.92



**Item No.: 216-243**  
 Ferrule; Sleeve for 1 mm<sup>2</sup> / AWG 18; insulated; electro-tin plated; electrolytic copper; gastight crimped; acc. to DIN 46228, Part 4/09.90; red



**Item No.: 216-263**  
 Ferrule; Sleeve for 1 mm<sup>2</sup> / AWG 18; insulated; electro-tin plated; electrolytic copper; gastight crimped; acc. to DIN 46228, Part 4/09.90; red



**Item No.: 216-143**  
 Ferrule; Sleeve for 1 mm<sup>2</sup> / AWG 18; un-insulated; electro-tin plated; electrolytic copper; gastight crimped; acc. to DIN 46228, Part 1/08.92

**1.1.2 Marking**

**1.1.2.1 Marking strip**



**Item No.: 210-332/500-202**  
 Marking strips; as a DIN A4 sheet; MARKED; 1-16 (160x); Height of marker strip: 3 mm; Strip length 182 mm; Horizontal marking; Self-adhesive; white



**Item No.: 210-332/508-202**  
 Marking strips; as a DIN A4 sheet; MARKED; 1-16 (160x); Height of marker strip: 3 mm; Strip length 182 mm; Horizontal marking; Self-adhesive; white



**Item No.: 210-332/500-205**  
 Marking strips; as a DIN A4 sheet; MARKED; 1-32 (80x); Height of marker strip: 3 mm; Strip length 182 mm; Horizontal marking; Self-adhesive; white



**Item No.: 210-332/508-205**  
 Marking strips; as a DIN A4 sheet; MARKED; 1-32 (80x); Height of marker strip: 3 mm; Strip length 182 mm; Horizontal marking; Self-adhesive; white



**Item No.: 210-332/500-204**  
 Marking strips; as a DIN A4 sheet; MARKED; 17-32 (160x); Height of marker strip: 3 mm; Strip length 182 mm; Horizontal marking; Self-adhesive; white



**Item No.: 210-332/508-204**  
 Marking strips; as a DIN A4 sheet; MARKED; 17-32 (160x); Height of marker strip: 3 mm; Strip length 182 mm; Horizontal marking; Self-adhesive; white



**Item No.: 210-332/500-206**  
 Marking strips; as a DIN A4 sheet; MARKED; 33-48 (160x); Height of marker strip: 3 mm; Strip length 182 mm; Horizontal marking; Self-adhesive; white



**Item No.: 210-332/508-206**  
 Marking strips; as a DIN A4 sheet; MARKED; 33-48 (160x); Height of marker strip: 3 mm; Strip length 182 mm; Horizontal marking; Self-adhesive; white

**1.1.3 Tool**

**1.1.3.1 Operating tool**



**Item No.: 210-720**  
 Operating tool; Blade: 3.5 x 0.5 mm; with a partially insulated shaft; multicoloured



**Item No.: 210-657**  
 Operating tool; Blade: 3.5 x 0.5 mm; with a partially insulated shaft; short; multicoloured

## Installation Notes

### Conductor termination

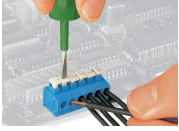

Inserting/removing fine-stranded conductors via push-button.

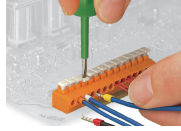

Insert/remove fine-stranded conductors with ferrules via push-button.

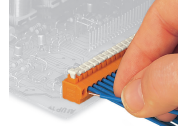

Insert solid conductors via push-in termination.

## Installation

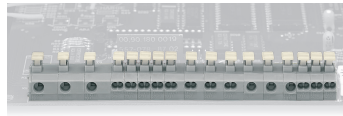
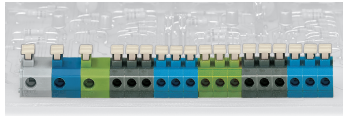

Combining 1- and 2-conductor terminal blocks with different pin spacing.

## Testing

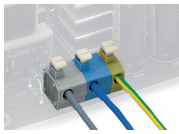

Application example: field-wiring terminal strip