

Data Sheet | Item Number: 281-613/281-542

2-conductor fuse terminal block; with pivoting fuse holder; for miniature metric fuse 1/4 x 1 mm; with blown fuse indication by LED; 30 - 65 V; for DIN-rail 35 x 15 and 35 x 7.5; 4 mm²; CAGE CLAMP®; gray

<https://www.wago.com/281-613/281-542>

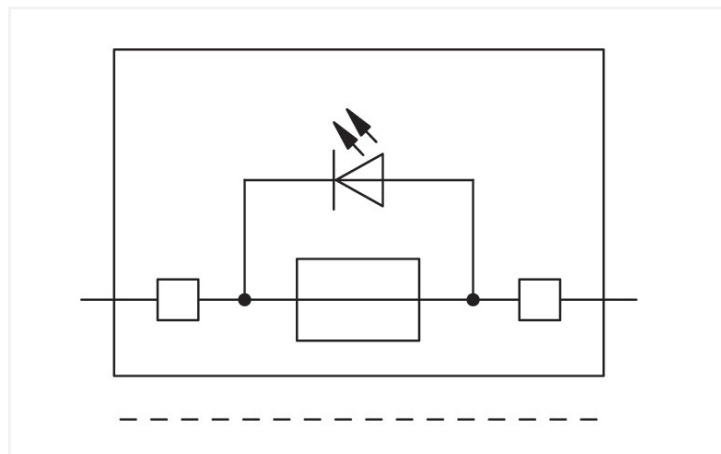
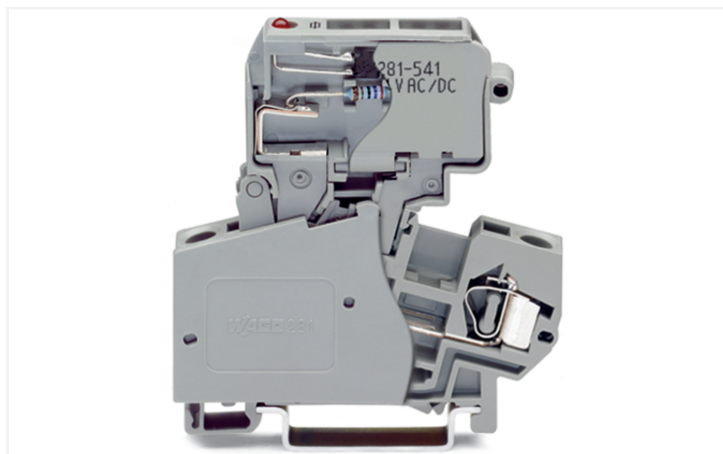

Color: ■ gray

Similar to illustration

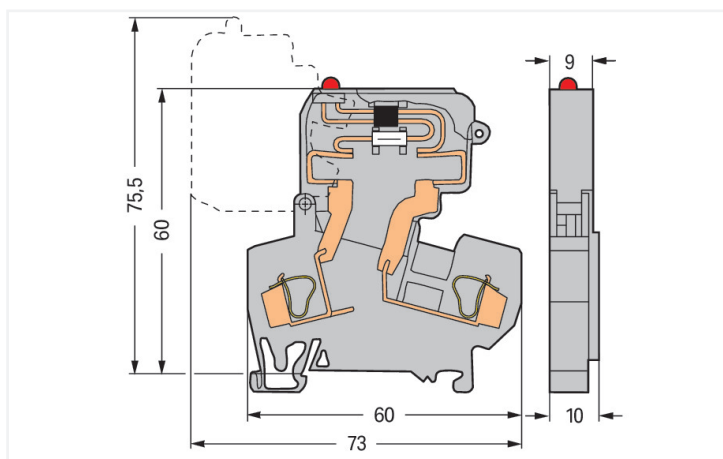

Dimensions in mm

Fuse terminal block, 281 Series, operating tool

Our fuse terminal block (item number 281-613/281-542) ensures effortless electrical installations. Ensure that the strip lengths are between 9 and 10 mm when connecting conductors to this fuse terminal block. This product features conductor terminals and utilizes CAGE CLAMP®. Our CAGE CLAMP® connection offers a proven and maintenance-free way to connect all types of conductors. You do not need to prepare the conductor in any way, such as crimping ferrules. This fuse terminal block is suitable for conductor cross sections ranging from 0.08 mm² to 4 mm².

Electrical data

Ratings per	IEC/EN 60947-7-3		
Overvoltage category	III	III	II
Pollution degree	3	2	2
Nominal voltage	800 V	-	-
Rated impulse withstand voltage	8 kV	-	-
Rated current	10 A	-	-

Ratings per IEC/EN – Notes	
Ratings (note)	Electrical ratings are given by the fuse and blown fuse indication.
Rated current (note)	Leakage current in case of a blown fuse: LED 6 mA

Power Loss

Power loss (max.) $P_{I(max)}$ (note)	When selecting glass cartridge fuses, make sure that the maximum power loss listed below is not exceeded. The power loss is determined according to IEC or EN 60947-7-3/VDE 0611-6 at 23°C. The temperature rise of the terminal block must be checked according to their application and mounting. Higher ambient temperatures represent an additional impact on miniature fuses. Therefore, in such applications, the rated current must be reduced if necessary. More details are available from the manufacturers.
---------------------------------------	--

Maximum power loss P_{loss} of fuse insert for overload and short-circuit protection (individual arrangement) 2.5 W

Maximum power loss P_{loss} of fuse insert for overload and short-circuit protection (block arrangement) 1.6 W

Power loss P_I max. short-circuit protection (individual arrangement) 4 W

Power loss P_{loss} (max.) of fuse cartridge for short-circuit protection (block arrangement) 2.5 W

General information

Fuse receptacle	pivoting
Fuse type	Cylindrical fuse; ¼" x 1"
Wiring direction	Front-entry wiring

Connection Data

Clamping units	2
Total number of potentials	2
Number of levels	1

Connection 1

Connection technology	CAGE CLAMP®
Actuation type	Operating tool
Connectable conductor materials	Copper Aluminum

Connectable conductor materials (note)

Terminating Aluminum Conductors

WAGO Spring-Clamp Terminal Blocks are suitable for solid aluminum conductors up to 4 mm²/12 AWG if WAGO "Alu-Plus" Contact Paste [249-130](#) is used for termination.

"Alu-Plus" Contact Paste Advantages:

- Automatically destroys the oxide film during clamping.
- Prevents fresh oxidation at the clamping point.
- Prevents electrolytic corrosion between aluminum and copper conductors (in the same terminal block).
- Provides long-term protection against corrosion.

Using terminal blocks with CAGE CLAMP® Spring Pressure Connection Technology, **aluminum conductors must first be cleaned with a blade** and then immediately inserted into the clamping units filled with "Alu-Plus" contact paste.

It is also possible to apply WAGO "Alu-Plus" **additionally** on the whole surface of the aluminum conductor before termination.

Please note that the nominal currents must be adapted to the reduced conductivity of the aluminum conductors:
2.5 mm² = 16 A
4 mm² = 22 A

Solid conductor	0.08 ... 4 mm ² / 28 ... 12 AWG
Fine-stranded conductor	0.08 ... 4 mm ² / 28 ... 12 AWG
Strip length	9 ... 10 mm / 0.35 ... 0.39 inches
Wiring direction	Front-entry wiring

Physical data

Width	10 mm / 0.394 inches
Height	60 mm / 2.362 inches
Depth from upper-edge of DIN-rail	60 mm / 2.362 inches

Mechanical data

Design	angled
Mounting type	DIN-35 rail
Marking level	Center marking

Material data

Note (material data)	Information on material specifications can be found here
Color	gray
Material group	I
Insulation material (main housing)	Polyamide (PA66)
Flammability class per UL94	V0
Fire load	0.387 MJ
Weight	20.1 g

Environmental requirements

Processing temperature	-35 ... +85 °C
Continuous operating temperature	-60 ... +105 °C

Commercial data

Product Group	1 (Rail Mounted Terminal Blocks)
PU (SPU)	50 pcs
Packaging type	Box
Country of origin	DE
GTIN	4045454319458
Customs tariff number	85369095000

Product Classification

UNSPSC	39121410
eCl@ss 10.0	27-14-11-16
eCl@ss 9.0	27-14-11-16
ETIM 9.0	EC000899
ETIM 10.0	EC000899
ECCN	NO US CLASSIFICATION

Environmental Product Compliance

CAS-No.	7439-92-1
REACH Candidate List Substance	Lead
RoHS Compliance Status	Compliant,With Exemption
RoHS Exemption	7(a) 7(c)-I
SCIP notification number (Austria)	bb6a19f9-ae4b-4577-b6d6-0ac881a0f68e
SCIP notification number (Belgium)	d73fc252-a01f-4f87-ab67-f739877f4301
SCIP notification number (Bulgaria)	afcfaa42-f4fc-4571-936a-e1e04bb66012
SCIP notification number (Czech Republic)	69f06ed5-7678-47b7-a51e-1b92e0109d97
SCIP notification number (Denmark)	9051237a-b1cf-4464-aecb-8151198f5c84
SCIP notification number (Finland)	aab3c6ef-5bec-49e1-b924-83941932178e
SCIP notification number (France)	e57b3bea-0d79-471b-8b35-8b859628ac37

Environmental Product Compliance

SCIP notification number (Germany)	356210ae-e9f1-4cd3-8824-e6fb457a34ed
SCIP notification number (Hungary)	b6148f23-e9db-45ac-bc7c-7897d28401f3
SCIP notification number (Italy)	1631d537-3d31-472b-8c70-bb65378c532f
SCIP notification number (Netherlands)	be97655d-ff55-4a49-b49d-af614bde3c36
SCIP notification number (Poland)	ab8c32ef-ca65-46a8-aaaf-b3ff9933da42
SCIP notification number (Romania)	7782a9bd-ecfc-4d29-be79-7e1a79db239e
SCIP notification number (Sweden)	ea119a08-6827-4ae0-a328-8acc9c89f7f

Approvals / Certificates

General approvals



Approval	Standard	Certificate Name
CSA CSA Group	C22.2	1505034
KEMA/KEUR DEKRA Certification B.V.	EN 60947	NTR NL-7135
KEMA/KEUR DEKRA Certification B.V.	EN 60947	2160584.31
UR UL International Germany GmbH	UL 1059	E45172

Declarations of conformity and manufacturer's declarations

Approval	Standard	Certificate Name
EU-Declaration of Confor- mity WAGO GmbH & Co. KG	-	-

Approvals for marine applications



Approval	Standard	Certificate Name
ABS American Bureau of Ship- ping	-	24-0152298-PDA
DNV GL Det Norske Veritas, Ger- manischer Lloyd	-	TAE00001V2
PRS Polski Rejestr Statków	-	TE/1094/880590/23

Downloads

Environmental Product Compliance

Compliance Search
Environmental Product Compliance 281-613/281-542



Documentation

Bid Text			
281-613/281-542	19.02.2019	xml 3.60 KB	↓
281-613/281-542	14.03.2017	doc 25.50 KB	↓

CAD/CAE-Data

CAD data	CAE data
2D/3D Models 281-613/281-542 ↓	EPLAN Data Portal 281-613/281-542 ↓
	WSCAD Universe 281-613/281-542 ↓
	ZUKEN Portal 281-613/281-542 ↓

1 Compatible Products

1.1 Optional Accessories

1.1.1 DIN-rail

1.1.1.1 Mounting accessories



Item No.: 210-196

Aluminum carrier rail; 35 x 8.2 mm; 1.6 mm thick; 2 m long; unslotted; similar to EN 60715; silver-colored



Item No.: 210-198

Copper carrier rail; 35 x 15 mm; 2.3 mm thick; 2 m long; unslotted; according to EN 60715; copper-colored



Item No.: 210-508

Steel carrier rail; 35 x 15 mm; 1.5 mm thick; 2 m long; slotted; galvanized; similar to EN 60715; silver-colored



Item No.: 210-197

Steel carrier rail; 35 x 15 mm; 1.5 mm thick; 2 m long; slotted; similar to EN 60715; silver-colored



Item No.: 210-506

Steel carrier rail; 35 x 15 mm; 1.5 mm thick; 2 m long; unslotted; galvanized; similar to EN 60715; silver-colored



Item No.: 210-114

Steel carrier rail; 35 x 15 mm; 1.5 mm thick; 2 m long; unslotted; similar to EN 60715; silver-colored



Item No.: 210-118

Steel carrier rail; 35 x 15 mm; 2.3 mm thick; 2 m long; unslotted; according to EN 60715; silver-colored



Item No.: 210-115

Steel carrier rail; 35 x 7.5 mm; 1 mm thick; 2 m long; slotted; according to EN 60715; "Hole width 18 mm; silver-colored



Item No.: 210-112

Steel carrier rail; 35 x 7.5 mm; 1 mm thick; 2 m long; slotted; according to EN 60715; "Hole width 25 mm; silver-colored



Item No.: 210-504

Steel carrier rail; 35 x 7.5 mm; 1 mm thick; 2 m long; slotted; galvanized; according to EN 60715; silver-colored



Item No.: 210-113

Steel carrier rail; 35 x 7.5 mm; 1 mm thick; 2 m long; unslotted; according to EN 60715; silver-colored



Item No.: 210-505

Steel carrier rail; 35 x 7.5 mm; 1 mm thick; 2 m long; unslotted; galvanized; according to EN 60715; silver-colored

1.1.2 End plate

1.1.2.1 End plate



Item No.: 281-311

End and intermediate plate; 2.5 mm thick; gray



Item No.: 281-309

End and intermediate plate; 2.5 mm thick; orange

1.1.3 Ferrule

1.1.3.1 Ferrule



Item No.: 216-241

Ferrule; Sleeve for 0.5 mm² / 20 AWG; insulated; electro-tin plated; electrolytic copper; gastight crimped; acc. to DIN 46228, Part 4/09.90; white



Item No.: 216-242

Ferrule; Sleeve for 0.75 mm² / 18 AWG; insulated; electro-tin plated; electrolytic copper; gastight crimped; acc. to DIN 46228, Part 4/09.90; gray



Item No.: 216-243

Ferrule; Sleeve for 1 mm² / AWG 18; insulated; electro-tin plated; electrolytic copper; gastight crimped; acc. to DIN 46228, Part 4/09.90; red



Item No.: 216-244

Ferrule; Sleeve for 1.5 mm² / AWG 16; insulated; electro-tin plated; electrolytic copper; gastight crimped; acc. to DIN 46228, Part 4/09.90; black



Item No.: 216-246

Ferrule; Sleeve for 2.5 mm² / AWG 14; insulated; electro-tin plated; electrolytic copper; gastight crimped; acc. to DIN 46228, Part 4/09.90; blue



Item No.: 216-106

Ferrule; Sleeve for 2.5 mm² / AWG 14; un-insulated; electro-tin plated; silver-colored

1.1.4 Installation

1.1.4.1 Cover



Item No.: 709-153

Cover; Type 1; suitable for cover carrier, type 1; 1 m long; transparent

1.1.4.2 Cover carrier



Item No.: 709-167

Cover carrier; Type 1; incl. fixing/retaining screws and knurled nut; suitable for 279 to 282 and 880 Series rail-mounted terminal blocks; suitable for 264 Series miniature rail-mounted terminal blocks; suitable for 270 Series sensor and actuator terminal blocks; gray

1.1.4.3 Mounting accessories



Item No.: 209-106

Mounting carrier; for isolated mounting on DIN 35 rails; gray



Item No.: 249-116

Screwless end stop; 6 mm wide; for DIN-rail 35 x 15 and 35 x 7.5; gray

1.1.5 Jumper

1.1.5.1 Jumper



Item No.: 281-402

Jumper; insulated; gray



Item No.: 709-110

Wire commoning chain; 2.5 mm²; insulated; black



Item No.: 709-111

Wire commoning chain; 2.5 mm²; insulated; black



Item No.: 709-112

Wire commoning chain; 2.5 mm²; insulated; black



Item No.: 210-103

Wire commoning chain; insulated; black



Item No.: 210-123

Wire commoning chain; insulated; blue

1.1.6 Locking system

1.1.6.1 Locking system



Item No.: 210-254

Interlocking link; mechanically locks multiple links; 1 m long; transparent

1.1.7 Marking

1.1.7.1 Marker



Item No.: 793-5501/000-006

WMB marking card; as card; for terminal block width 5 - 17.5 mm; stretchable 5 - 5.2 mm; plain; snap-on type; blue



Item No.: 793-5501/000-007

WMB marking card; as card; for terminal block width 5 - 17.5 mm; stretchable 5 - 5.2 mm; plain; snap-on type; gray



Item No.: 793-5501/000-023

WMB marking card; as card; for terminal block width 5 - 17.5 mm; stretchable 5 - 5.2 mm; plain; snap-on type; green



Item No.: 793-5501/000-017

WMB marking card; as card; for terminal block width 5 - 17.5 mm; stretchable 5 - 5.2 mm; plain; snap-on type; light green



Item No.: 793-5501/000-012

WMB marking card; as card; for terminal block width 5 - 17.5 mm; stretchable 5 - 5.2 mm; plain; snap-on type; orange



Item No.: 793-5501/000-005

WMB marking card; as card; for terminal block width 5 - 17.5 mm; stretchable 5 - 5.2 mm; plain; snap-on type; red



Item No.: 793-5501/000-024

WMB marking card; as card; for terminal block width 5 - 17.5 mm; stretchable 5 - 5.2 mm; plain; snap-on type; violet



Item No.: 793-5501

WMB marking card; as card; for terminal block width 5 - 17.5 mm; stretchable 5 - 5.2 mm; plain; snap-on type; white



Item No.: 793-5501/000-002

WMB marking card; as card; for terminal block width 5 - 17.5 mm; stretchable 5 - 5.2 mm; plain; snap-on type; yellow



Item No.: 793-501/000-006

WMB marking card; as card; not stretchable; plain; snap-on type; blue



Item No.: 793-501/000-007

WMB marking card; as card; not stretchable; plain; snap-on type; gray



Item No.: 793-501/000-023

WMB marking card; as card; not stretchable; plain; snap-on type; green



Item No.: 793-501/000-017

WMB marking card; as card; not stretchable; plain; snap-on type; light green



Item No.: 793-501/000-012

WMB marking card; as card; not stretchable; plain; snap-on type; orange



Item No.: 793-501/000-005

WMB marking card; as card; not stretchable; plain; snap-on type; red



Item No.: 793-501/000-024

WMB marking card; as card; not stretchable; plain; snap-on type; violet



Item No.: 793-501

WMB marking card; as card; not stretchable; plain; snap-on type; white



Item No.: 793-501/000-002

WMB marking card; as card; not stretchable; plain; snap-on type; yellow



Item No.: 2009-115/000-006

WMB-Inline; for Smart Printer; 1500 pieces on roll; stretchable 5 - 5.2 mm; plain; snap-on type; blue



Item No.: 2009-115/000-007

WMB-Inline; for Smart Printer; 1500 pieces on roll; stretchable 5 - 5.2 mm; plain; snap-on type; gray



Item No.: 2009-115/000-023

WMB-Inline; for Smart Printer; 1500 pieces on roll; stretchable 5 - 5.2 mm; plain; snap-on type; green



Item No.: 2009-115/000-017

WMB-Inline; for Smart Printer; 1500 pieces on roll; stretchable 5 - 5.2 mm; plain; snap-on type; light green



Item No.: 2009-115/000-012

WMB-Inline; for Smart Printer; 1500 pieces on roll; stretchable 5 - 5.2 mm; plain; snap-on type; orange



Item No.: 2009-115/000-024

WMB-Inline; for Smart Printer; 1500 pieces on roll; stretchable 5 - 5.2 mm; plain; snap-on type; violet



Item No.: 2009-115

WMB-Inline; for Smart Printer; 1500 pieces on roll; stretchable 5 - 5.2 mm; plain; snap-on type; white



Item No.: 2009-115/000-002

WMB-Inline; for Smart Printer; 1500 pieces on roll; stretchable 5 - 5.2 mm; plain; snap-on type; yellow

1.1.8 Push-in type wire jumper

1.1.8.1 Jumper



Item No.: 249-126

Push-in type wire jumper; 0.75 mm²; insulated; 110 mm long; black



Item No.: 249-123

Push-in type wire jumper; 0.75 mm²; insulated; 180 mm long; black



Item No.: 249-127

Push-in type wire jumper; 0.75 mm²; insulated; 250 mm long; black



Item No.: 249-125

Push-in type wire jumper; insulated; 60 mm long; black

1.1.9 Test and measurement

1.1.9.1 Testing accessories



Item No.: 249-147

B-type test plug module; modular; 2,50 mm²; gray



Item No.: 280-404

Test plug adapter; 5 mm wide; for test plug (2.3 mm Ø); suitable for 1.5 mm² - 4 mm² tbs; gray



Item No.: 281-407

Test plug; 6 mm wide; Nominal current 24 A; for 0.08 mm² - 2.5 mm²; gray

1.1.10 Tool

1.1.10.1 Operating tool



Item No.: 210-658

Operating tool; Blade: 3.5 x 0.5 mm; with a partially insulated shaft; angled; short; multicoloured



Item No.: 210-720

Operating tool; Blade: 3.5 x 0.5 mm; with a partially insulated shaft; multicoloured



Item No.: 210-657

Operating tool; Blade: 3.5 x 0.5 mm; with a partially insulated shaft; short; multicoloured

Installation Notes

Conductor termination



CAGE CLAMP® connection

Inserting a conductor.

With ferruled conductors, it is necessary to use a terminal block one size smaller than the conductor's nominal cross-section.

Commoning

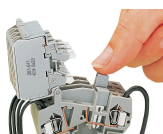

Commoning

Distributing current to several fuse-protected circuits via insulated push-in type jumpers.

Testing

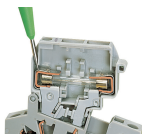

Voltage test, either at input or output with fuse holder in closed position (live)

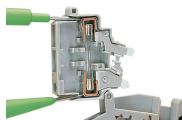

Through test with fuse holder in open position (no voltage)



Voltage test at input in the test slot of the current bar

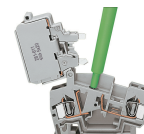

Testing voltage at the output via separate test slot.



Measuring current between jumper slot and separate test slot.



Testing voltage (input side) via test plug adapter (280-404, shown) or test plug (281-407).

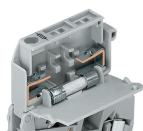

5 x 20 mm, 5 x 25 mm and 1/4" x 1" fuse holders are fitted with stops on the inside of the cover.

Security



Touch-proof protection in all positions of the fuse holder

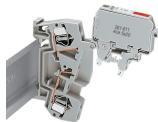

Fuse holder will remain safely locked open in vertical assemblies.

Locking system

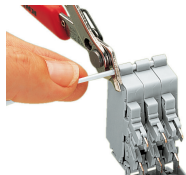

Ganging several fuse holders with an interlocking link (example shows 8 mm wide terminal blocks).

Application

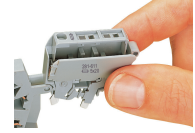
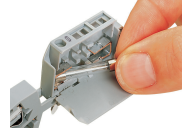
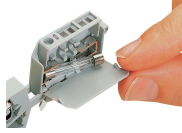

Fuse replacement:

Before replacing a fuse, pivot the fuse holder into the locked open position.

Fuse replacement:

One end of the fuse is automatically ejected from the holder when opening the cover.

Fuse replacement:

Easily removing a fuse by hand.

Fuse replacement:

Insert a new fuse and snap the cover closed.



An intermediate plate is supplied with all 10 mm wide fused disconnect terminal blocks. At the end of an assembly, or if there is **no** adjacent fused disconnect terminal block, an end or intermediate plate must be used.

Marking



All fuse holders are printed with correct fuse size.



Each fuse holder features two marker slots for custom WMB Multi markers (example shows 8 mm wide terminal blocks).