

Data Sheet | Item Number: 233-124

PCB terminal block; 0.5 mm²; Pin spacing 2.5 mm; 24-pole; CAGE CLAMP®; gray

<https://www.wago.com/233-124>

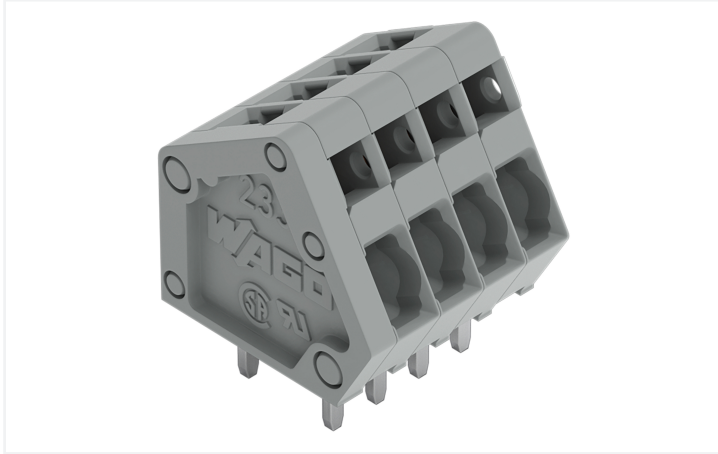

Color: ■ gray

Similar to illustration

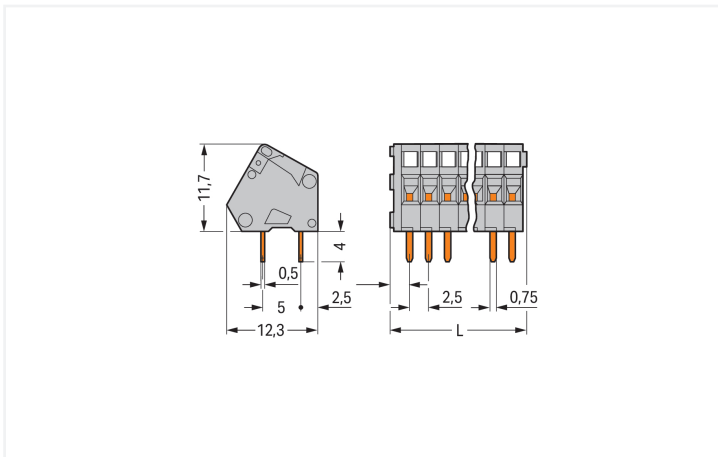
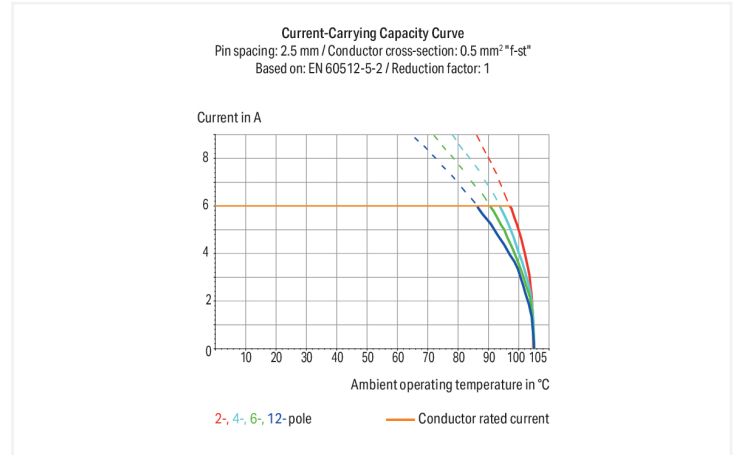

Dimensions in mm

$L = (\text{pole no.} \times \text{pin spacing}) + 2.3 \text{ mm}$

PCB terminal block, 233 Series, gray

Our PCB terminal block (item number 233-124) ensures effortless electrical installations. It offers the flexibility needed for different mounting types. Ensure that the strip lengths are between 5 and 6 mm when connecting conductors to this PCB terminal block. Featuring one conductor terminal along with CAGE CLAMP®, this connector is highly versatile. Our trusted universal connection known as CAGE CLAMP® leads the way when it comes to connection technology and electrical interconnections. The dimensions are (62.3 x 15.7 x 12.1) mm (width x height x depth). This PCB terminal block is suitable for conductor cross sections ranging from 0.08 mm² to 0.5 mm². Tin is used for coating the contact surfaces. This PCB terminal block is operated with an operating tool. The PCB terminal block is designed for THT soldering. The conductor is designed to be inserted into the board at an angle of 30°.

Notes

| | |
|-----------|--|
| Variants: | Other pole numbers Other colors Mixed-color PCB connector strips Direct marking Other versions (or variants) can be requested from WAGO Sales or configured at https://configurator.wago.com/ . |
|-----------|--|

Electrical data

| Ratings per | IEC/EN 60664-1 | | | Approvals per | UL 1059 | | |
|---------------------------------|----------------|--------|--------|---------------|---------|---|---|
| Overvoltage category | III | III | II | Use group | B | C | D |
| Pollution degree | 3 | 2 | 2 | Rated voltage | 150 V | - | - |
| Nominal voltage | 63 V | 160 V | 320 V | Rated current | 4 A | - | - |
| Rated impulse withstand voltage | 2.5 kV | 2.5 kV | 2.5 kV | | | | |
| Rated current | 6 A | 6 A | 6 A | | | | |

| Approvals per | CSA | | |
|---------------|-------|---|---|
| Use group | B | C | D |
| Rated voltage | 150 V | - | - |
| Rated current | 4 A | - | - |

Connection Data

| | | | |
|----------------------------|----|---|---|
| Clamping units | 24 | Connection 1 | |
| Total number of potentials | 24 | Connection technology | CAGE CLAMP® |
| Number of connection types | 1 | Actuation type | Operating tool |
| Number of levels | 1 | Solid conductor | 0.08 ... 0.5 mm ² / 28 ... 20 AWG |
| | | Fine-stranded conductor | 0.08 ... 0.5 mm ² / 28 ... 20 AWG |
| | | Fine-stranded conductor; with insulated ferrule | 0.25 mm ² |
| | | Fine-stranded conductor; with uninsulated ferrule | 0.25 mm ² |
| | | Note (conductor cross-section) | Terminating 0.75 mm ² /18 AWG conductors is possible; however insulation diameter allows only every other clamping unit to be terminated with this conductor size. |
| | | Strip length | 5 ... 6 mm / 0.2 ... 0.24 inches |
| | | Conductor connection direction to PCB | 30 ° |
| | | Pole number | 24 |

Physical data

| | |
|-------------------------|--------------------------|
| Pin spacing | 2.5 mm / 0.098 inches |
| Width | 62.3 mm / 2.453 inches |
| Height | 15.7 mm / 0.618 inches |
| Height from the surface | 11.7 mm / 0.461 inches |
| Depth | 12.1 mm / 0.476 inches |
| Solder pin length | 4 mm |
| Solder pin dimensions | 0.5 x 0.75 mm |
| ! | 1.1 ^(±0.1) mm |

PCB contact

| | |
|-------------------------------------|--|
| PCB contact | THT |
| Solder pin arrangement | over the entire terminal strip (in-line) |
| Number of solder pins per potential | 2 |

Material data

| | |
|------------------------------------|--|
| Note (material data) | Information on material specifications can be found here |
| Color | gray |
| Material group | I |
| Insulation material (main housing) | Polyamide (PA66) |
| Flammability class per UL94 | V0 |
| Clamping spring material | Chrome-nickel spring steel (CrNi) |
| Contact material | Electrolytic copper (E _{cu}) |
| Contact Plating | Tin |
| Fire load | 0.1 MJ |
| Weight | 8.1 g |

Environmental requirements

| | |
|-------------------------|-----------------|
| Limit temperature range | -60 ... +105 °C |
|-------------------------|-----------------|

Commercial data

| | |
|-----------------------|--------------------------------|
| Product Group | 4 (Printed Circuit Connectors) |
| PU (SPU) | 80 (20) pcs |
| Packaging type | Box |
| Country of origin | CH |
| GTIN | 4045454049362 |
| Customs tariff number | 85369010000 |

Product Classification

| | |
|-------------|----------------------|
| UNSPSC | 39121409 |
| eCl@ss 10.0 | 27-44-04-01 |
| eCl@ss 9.0 | 27-44-04-01 |
| ETIM 9.0 | EC002643 |
| ETIM 10.0 | EC002643 |
| ECCN | NO US CLASSIFICATION |

Environmental Product Compliance

| | |
|------------------------|-------------------------|
| RoHS Compliance Status | Compliant, No Exemption |
|------------------------|-------------------------|

Approvals / Certificates

General approvals



| Approval | Standard | Certificate Name |
|---------------------------------|--------------|------------------|
| CCA DEKRA Certification B.V. | EN 60998 | NTR NL 6946 |
| CCA DEKRA Certification B.V. | EN 60998 | 2153951.01 |
| CCA DEKRA Certification B.V. | EN 60947-7-4 | NTR NL 7786 |

General approvals

| | | |
|---------------------------------------|--------------|-----------|
| CSA DEKRA Certification B.V. | C22.2 | 1465035 |
| KEMA/KEUR DEKRA Certification B.V. | EN 60947-7-4 | 71-111040 |
| UL UL International Germany GmbH | UL 1059 | E45172 |

Declarations of conformity and manufacturer's declarations

| Approval | Standard | Certificate Name |
|--|----------|------------------|
| EU-Declaration of Conformity WAGO GmbH & Co. KG | - | - |
| UK-Declaration of Conformity WAGO GmbH & Co. KG | - | - |

Approvals for marine applications



| Approval | Standard | Certificate Name |
|------------------------------------|----------|-------------------|
| ABS American Bureau of Shipping | - | 24-0095975-PDA |
| DNV DNV GL SE | - | TAE000016Z |
| PRS Polski Rejestr Statków | - | TE/1095/880590/23 |

Downloads

Environmental Product Compliance

| Compliance Search |
|--|
| Environmental Product Compliance 233-124 ↓ |

Documentation

| Additional Information | | | |
|------------------------|------------|-------------------|-------------------|
| Technical Section | 03.04.2019 | pdf 2027.26 KB | ↓ |

CAD/CAE-Data

| CAD data |
|--|
| 2D/3D Models 233-124 ↓ |

| CAE data |
|---|
| EPLAN Data Portal 233-124 ↓ |
| ZUKEN Portal 233-124 ↓ |

PCB Design

| |
|--|
| Symbol and Footprint via SamacSys 233-124 ↓ |
| Symbol and Footprint via Ultra Librarian 233-124 ↓ |

1 Compatible Products

1.1 Optional Accessories

1.1.1 Ferrule

1.1.1.1 Ferrule



Item No.: 216-301

Ferrule; Sleeve for 0.25 mm² / AWG 24; insulated; electro-tin plated; yellow

Item No.: 216-321

Ferrule; Sleeve for 0.25 mm² / AWG 24; insulated; electro-tin plated; yellow

Item No.: 216-151

Ferrule; Sleeve for 0.25 mm² / AWG 24; uninsulated; electro-tin plated

Item No.: 216-131

Ferrule; Sleeve for 0.25 mm² / AWG 24; uninsulated; electro-tin plated; silver-colored

1.1.2 Marking

1.1.2.1 Marking strip



Item No.: 210-331/250-202

Marking strips; as a DIN A4 sheet; MARKED; 1-16 (400x); Height of marker strip: 2.3 mm/0.091 in; Strip length 182 mm; Horizontal marking; Self-adhesive; white

Item No.: 210-331/254-202

Marking strips; as a DIN A4 sheet; MARKED; 1-16 (400x); Height of marker strip: 2.3 mm/0.091 in; Strip length 182 mm; Horizontal marking; Self-adhesive; white

Item No.: 210-331/250-207

Marking strips; as a DIN A4 sheet; MARKED; 1-48 (100x); Height of marker strip: 2.3 mm/0.091 in; Strip length 182 mm; Horizontal marking; Self-adhesive; white

Item No.: 210-331/254-207

Marking strips; as a DIN A4 sheet; MARKED; 1-48 (100x); Height of marker strip: 2.3 mm/0.091 in; Strip length 182 mm; Horizontal marking; Self-adhesive; white



Item No.: 210-331/250-204

Marking strips; as a DIN A4 sheet; MARKED; 17-32 (400x); Height of marker strip: 2.3 mm/0.091 in; Strip length 182 mm; Horizontal marking; Self-adhesive; white

Item No.: 210-331/254-204

Marking strips; as a DIN A4 sheet; MARKED; 17-32 (400x); Height of marker strip: 2.3 mm/0.091 in; Strip length 182 mm; Horizontal marking; Self-adhesive; white

Item No.: 210-331/250-206

Marking strips; as a DIN A4 sheet; MARKED; 33-48 (400x); Height of marker strip: 2.3 mm/0.091 in; Strip length 182 mm; Horizontal marking; Self-adhesive; white

Item No.: 210-331/254-206

Marking strips; as a DIN A4 sheet; MARKED; 33-48 (400x); Height of marker strip: 2.3 mm/0.091 in; Strip length 182 mm; Horizontal marking; Self-adhesive; white

1.1.3 Tool

1.1.3.1 Operating tool



Item No.: 210-719

Operating tool; Blade: 2.5 x 0.4 mm; with a partially insulated shaft

Item No.: 210-648

Operating tool; Blade: 2.5 x 0.4 mm; with a partially insulated shaft; angled; short

Item No.: 210-647

Operating tool; Blade: 2.5 x 0.4 mm; with a partially insulated shaft; multicoloured

Item No.: 233-335

Operating tool; green



Item No.: 233-331

Operating tool; insulated; yellow

Item No.: 233-332

Operating tool; made of insulating material; white

Installation Notes

Conductor termination

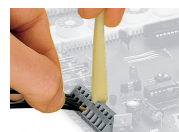
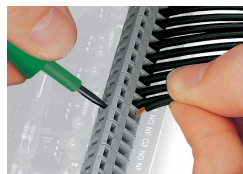

Inserting a conductor via 3.5 mm screwdriver.
Screwdriver actuation parallel to conductor entry

Inserting a conductor via 3.5 mm screwdriver.
Screwdriver actuation perpendicular to conductor entry

Inserting a conductor via operating tool.

Compared to standard screwdrivers, these operating tools are far more convenient for wiring PCB terminal strips at factory.

Installation

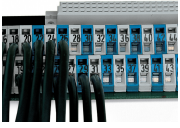

PCB Terminal Strips placed behind each other save space – staggering them by half the pin spacing simplifies subsequent wiring of the first row.

Installation



Combining PCB terminal blocks with different pin spacing.

Marking



Optional: Labeling via factory direct marking.

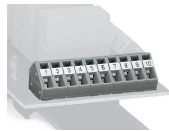

Optional: Labeling with self-adhesive marking strips possible