

Data Sheet | Item Number: 250-1402

PCB terminal block; push-button; 0.5 mm²; Pin spacing 2.54 mm; 2-pole; Push-in CAGE CLAMP®; gray

<https://www.wago.com/250-1402>

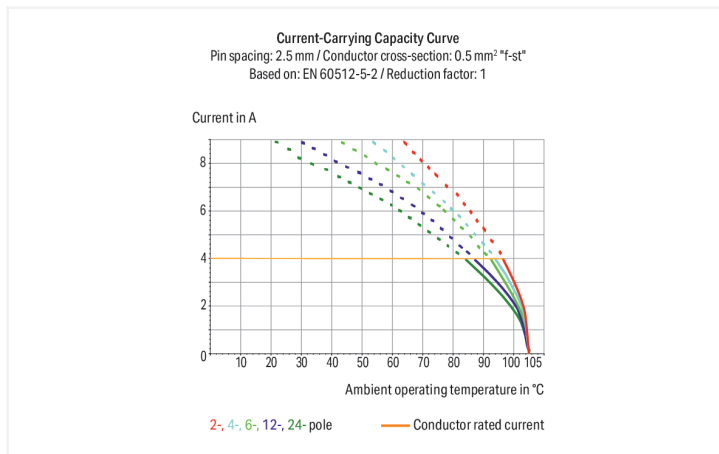

Color: ■ gray

Similar to illustration

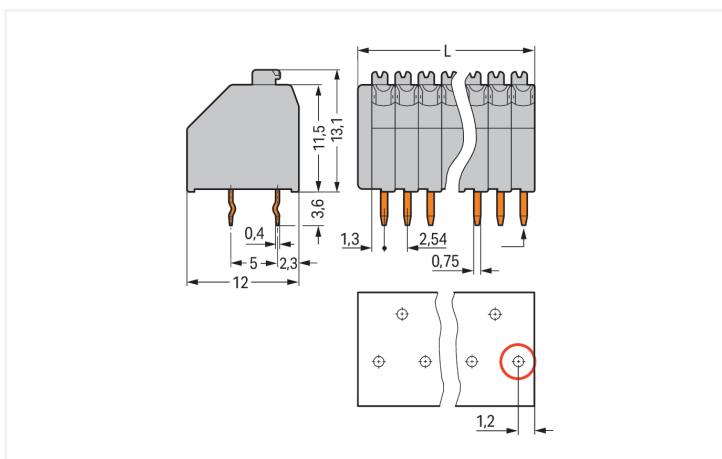

Dimensions in mm

L = (pole no. x pin spacing) + 1.5 mm First solder pin, front right (red circle)

PCB terminal block, 250 Series, solder pin dimensions 0.4 x 0.75 mm

Connect conductors quickly and safely with this PCB terminal block (item number 250-1402). You can rely on proven safety with these PCB terminal blocks, perfect for a wide range of applications when designing your devices. Ensure that the strip lengths are between 8.5 and 9.5 mm when connecting conductors to this PCB terminal block. This product incorporates one conductor terminal and utilizes Push-in CAGE CLAMP®. Push-in CAGE CLAMP® connection technology is ideal for connecting all conductor types. It allows direct insertion of both solid and fine-stranded conductors with ferrules without needing to use any tools—all thanks to its pluggable design. Dimensions: (6.58 x 16.7 x 12) mm (width x height x depth). Depending on the type of conductor, this PCB terminal block is suitable for conductor cross sections ranging from 0.14 mm² to 0.5 mm². Tin is used for coating the contact surfaces. This PCB terminal block is operated with a push-button. THT is used to assemble the PCB terminal block. Insert the conductor at a 45° angle..

Notes

Variants:	Other pole numbers Other colors Mixed-color PCB connector strips Terminal strips with spacers Direct marking Other versions (or variants) can be requested from WAGO Sales or configured at https://configurator.wago.com/ .
-----------	--

Electrical data

Ratings per	IEC/EN 60664-1			Approvals per	UL 1059		
Overvoltage category	III	III	II	Use group	B	C	D
Pollution degree	3	2	2	Rated voltage	300 V	-	300 V
Nominal voltage	160 V	160 V	320 V	Rated current	5 A	-	5 A
Rated impulse withstand voltage	2.5 kV	2.5 kV	2.5 kV				
Rated current	4 A	4 A	4 A				

Approvals per	CSA		
Use group	B	C	D
Rated voltage	300 V	-	300 V
Rated current	5 A	-	5 A

Connection Data

Clamping units	2	Connection 1	
Total number of potentials	2	Connection technology	Push-in CAGE CLAMP®
Number of connection types	1	Actuation type	Push-button
Number of levels	1	Solid conductor	0.14 ... 0.5 mm ² / 24 ... 20 AWG
		Fine-stranded conductor	0.2 ... 0.5 mm ² / 24 ... 20 AWG
		Conductor diameter	0.4 ... 0.8 mm / 24 ... 20 AWG
		Strip length	8.5 ... 9.5 mm / 0.33 ... 0.37 inches
		Conductor connection direction to PCB	45 °
		Pole number	2

Physical data

Pin spacing	2.54 mm / 0.1 inches
Width	6.58 mm / 0.259 inches
Height	16.7 mm / 0.657 inches
Height from the surface	13.1 mm / 0.516 inches
Depth	12 mm / 0.472 inches
Solder pin length	3.6 mm
Solder pin dimensions	0.4 x 0.75 mm
!	1.1 (+0.1) mm

PCB contact

PCB contact	THT
Solder pin arrangement	over the entire terminal strip (staggered)
Number of solder pins per potential	1

Material data

Note (material data)	Information on material specifications can be found here
Color	gray
Material group	I
Insulation material (main housing)	Polyamide (PA66)
Flammability class per UL94	V0
Clamping spring material	Copper alloy
Contact Plating	Tin
Fire load	0.022 MJ
Weight	0.9 g

Environmental requirements

Limit temperature range	-60 ... +105 °C
-------------------------	-----------------

Commercial data

Product Group	4 (Printed Circuit Connectors)
PU (SPU)	720 (180) pcs
Packaging type	Box
Country of origin	CH
GTIN	4044918643160
Customs tariff number	85369010000

Product Classification

UNSPSC	39121409
eCl@ss 10.0	27-44-04-01
eCl@ss 9.0	27-44-04-01
ETIM 9.0	EC002643
ETIM 10.0	EC002643
ECCN	NO US CLASSIFICATION

Environmental Product Compliance

RoHS Compliance Status	Compliant, No Exemption
------------------------	-------------------------

Approvals / Certificates

General approvals



Approval	Standard	Certificate Name
CCA DEKRA Certification B.V.	EN 60947	NTR NL 7833/2
CCA DEKRA Certification B.V.	EN 60998	NTR NL-7705/1

General approvals

CSA DEKRA Certification B.V.	C22.2	1132097
DEKRA DEKRA Certification B.V.	EN 60947-7-4	71-141963
KEMA/KEUR DEKRA Certification B.V.	EN 60947	2160584.18
KEMA/KEUR DEKRA Certification B.V.	EN 60998	71-124629
UL UL International Germany GmbH	UL 1059	E45172

Declarations of conformity and manufacturer's declarations

Approval	Standard	Certificate Name
EU-Declaration of Confor- mity WAGO GmbH & Co. KG	-	-
UK-Declaration of Confor- mity WAGO GmbH & Co. KG	-	-

Approvals for marine applications



Approval	Standard	Certificate Name
ABS American Bureau of Ship- ping	-	24-0095975-PDA
DNV DNV GL SE	-	TAE000016Z

Downloads

Environmental Product Compliance



Compliance Search
Environmental Product Compliance 250-1402 

Documentation



Additional Information
Technical Section 03.04.2019 pdf 2027.26 KB 

CAD/CAE-Data

CAD data
2D/3D Models 250-1402 

CAE data
EPLAN Data Portal 250-1402 
ZUKEN Portal 250-1402 

PCB Design

Symbol and Footprint via SamacSys 250-1402 
Symbol and Footprint via Ultra Librarian 250-1402 

1 Compatible Products

1.1 Optional Accessories

1.1.1 Marking

1.1.1.1 Marking strip



Item No.: 210-331/254-202

Marking strips; as a DIN A4 sheet; MARKED; 1-16 (400x); Height of marker strip: 2.3 mm/0.091 in; Strip length 182 mm; Horizontal marking; Self-adhesive; white

Item No.: 210-331/254-207

Marking strips; as a DIN A4 sheet; MARKED; 1-48 (100x); Height of marker strip: 2.3 mm/0.091 in; Strip length 182 mm; Horizontal marking; Self-adhesive; white

Item No.: 210-331/254-204

Marking strips; as a DIN A4 sheet; MARKED; 17-32 (400x); Height of marker strip: 2.3 mm/0.091 in; Strip length 182 mm; Horizontal marking; Self-adhesive; white

Item No.: 210-331/254-206

Marking strips; as a DIN A4 sheet; MARKED; 33-48 (400x); Height of marker strip: 2.3 mm/0.091 in; Strip length 182 mm; Horizontal marking; Self-adhesive; white

1.1.2 Test and measurement

1.1.2.1 Testing accessories



Item No.: 735-500

WAGO Test pin; 1 mm Ø; 30 V AC / 60 V DC; CAT0; 1 A; 6 mm uninsulated; Test lead for soldering up to 0,5mm²

1.1.3 Tool

1.1.3.1 Operating tool



Item No.: 210-719

Operating tool; Blade: 2.5 x 0.4 mm; with a partially insulated shaft

Item No.: 210-647

Operating tool; Blade: 2.5 x 0.4 mm; with a partially insulated shaft; multicoloured

Installation Notes



A groove at the back of the terminal strip differentiates between the two pin spacings.

Conductor termination



Inserting solid conductors via push-in termination.
Inserting fine-stranded conductors via push-buttons, 250 Series – 3.5 mm pin spacing.

Conductor termination



Space-saving wiring, 250 Series – 5 mm pin spacing.

Testing



Testing with 11 mm Ø test pin, on the conductor, 250 Series – 2.5 ... 3.5 mm pin spacing.



Testing with 2 mm Ø test plug, touch contact, 250 Series – 5 mm pin spacing.

Marking



Labeling via self-adhesive strips or direct marking. Mixed-color terminal strips (with or without spacer) are available upon request.



Labeling via self-adhesive strips or direct marking. Mixed-color terminal strips (with or without spacer) are available upon request.