











33 815 888 Product version from 5/31/2010 to 10/27/2020



- 236mm projection
- pivotable spout 360°
- air-enriched flow
- height of mixer 400 mm
- height up to aerator 230 mm
- hole diameter 35 mm
- max. flow 7 l/min at 3 bar flow pressure
- lead-free
- WRAS
- This product can help a building meet the requirements of Green Building Rating Systems, e.g. LEED®, BREEAM®, DGNB

	Platinum	33 815 888-08
	Chrome	33 815 888-00
	Brushed Platinum	33 815 888-06
	Durabronze (23kt Gold)	33 815 888-09
	Dark Chrome	33 815 888-19
	Brushed Durabronze (23kt Gold)	33 815 888-28
	Matte Black	33 815 888-33
	Brushed Dark Brass (PVD)	33 815 888-39
	Brushed Bronze (PVD)	33 815 888-42
	Brushed Dark Bronze (PVD)	33 815 888-43
	Brushed Champagne (22kt Gold)	33 815 888-46
	Champagne (22kt Gold)	33 815 888-47
	Brushed Chrome	33 815 888-93
	Brushed Dark Platinum	33 815 888-99

Recommended miscellaneous

Dispenser with rosette - Platinum 82 444 970-08



Recommended miscellaneous

Strainer waste with control handle - Platinum 10 710 970-08



33 815 888 Product version from 5/31/2010 to 10/27/2020

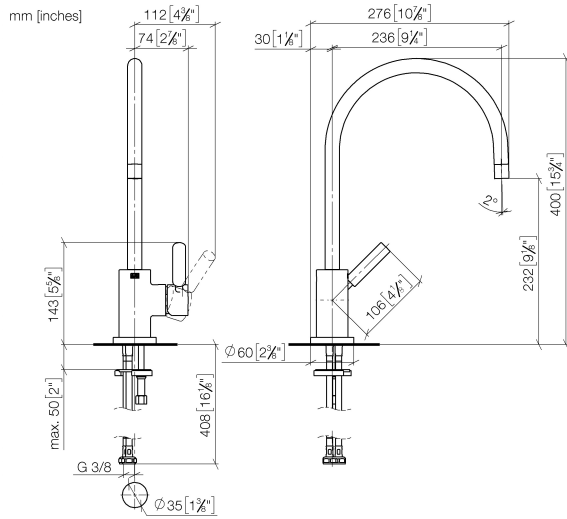

Flow rate chart



Codes & Standards

DIN 4109	EN 817	Executive Order no. 1007	ISO 3822
Scottish Water Byelaws	UK Water Supply Regulations	Ü-Zeichen	VA-Zeichen



TARA Single-lever mixer - Platinum

TARA

33 815 888 Product version from 5/31/2010 to 10/27/2020

Certificates and sustainability

WRAS_2311

GDV_0400

ETA_18

LGA_8

EPD-DOR-20230287
-IBA1-EN
Environmental.prod
uct-declarat

33 815 888 Product version from 5/31/2010 to 10/27/2020

Parts for other finishes can be found here: [Chrome](#)

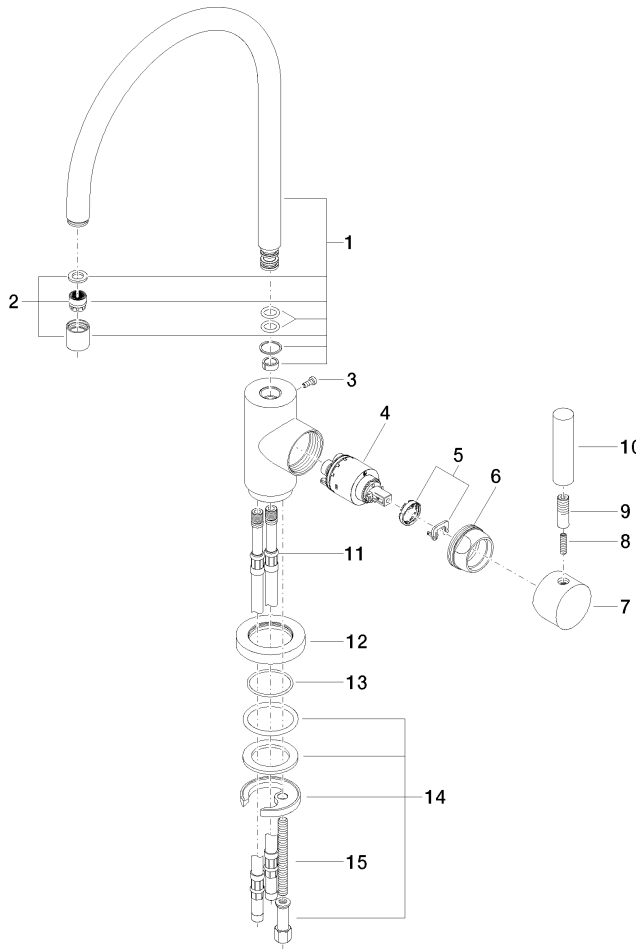

Spare parts list

No.	Item Number	Name	Quantity used	Delivery time
12	09 28 10 055-08	Rosette Ø 60 x Ø 38,2 x 10 mm - Platinum	1.00	-
Spare part can no longer be ordered, please order the replacement item				
15	09 31 11 011 90	Mounting Threaded bolt M8 x 80 mm -	1.00	14
3	09 30 30 054 90	Mounting Cylinder head screw with hexagon socket with low profile M4 x 10 mm -	1.00	14
1	90 28 22 049 02-08	Spout complete 7 l/min 235 mm - Platinum	1.00	54
8	09 31 11 010 90	Mounting Threaded pin with hexagon socket self-locking M5 x 20 mm -	1.00	14
7	90 20 88 040 00-08	Handle Lower part of lever 98 x 64 x 64 mm - Platinum	1.00	54
6	09 24 04 107-08	Connection Ø 40 x 20 mm - Platinum	1.00	54
4	90 15 05 065 00 90	Cartridge -	1.00	14
11	04 30 04 064 00 90	High pressure hose short shaft M10x1 x 420 mm -	2.00	-
Spare part can no longer be ordered, please order the replacement item				
	0430041040090	High pressure hose M10x1 x 3/8" x 420 mm -		
2	90 23 01 028 03-08	Aerator M18xIG 7,0 l/min. - Platinum	1.00	54
5	90 28 10 148 00 90	Temperature limitation ring -	1.00	14
14	04 30 11 038 00 90	Mounting with O-ring Ø40 x 4mm Ø 52 x 1,5 mm -	1.00	14
13	09 14 10 034 90	O-Ring EPDM 70 38,0 x 2,0 mm -	1.00	14
9	90 24 04 048 00-08	Sleeve Nipple - Platinum	1.00	54
10	11 170 880-08	Lever - Platinum	1.00	54