

Data Sheet | Item Number: 2202-1611/1000-867

2-conductor fuse terminal block; with pivoting fuse holder; with end plate; for 5 x 20 mm miniature metric fuse; with push-button; with blown fuse indication by LED; 120 V; for DIN-rail 35 x 15 and 35 x 7.5; 2.5 mm²; Push-in CAGE CLAMP®; 2,50 mm²; gray

<https://www.wago.com/2202-1611/1000-867>

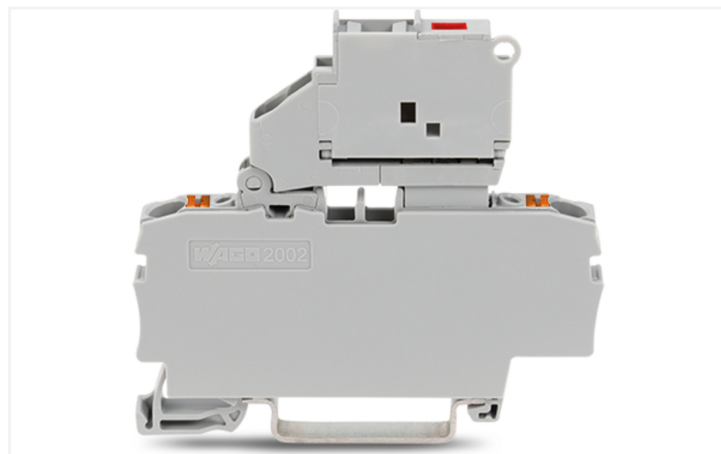
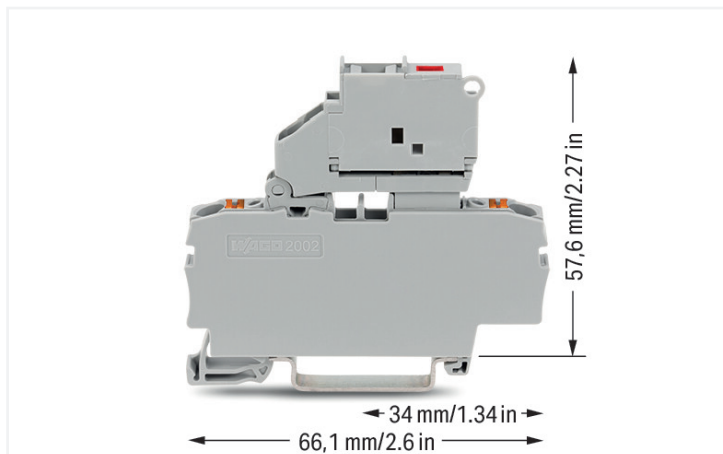

Color: ■ gray

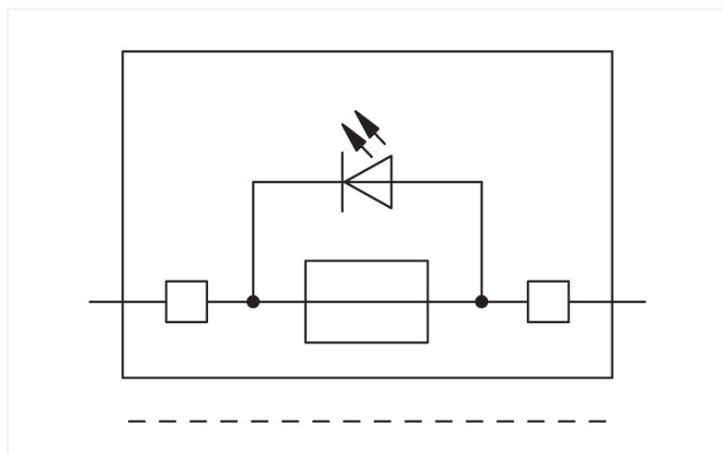

Fuse terminal block, 2202 Series, push-button

Quick and easy connections are guaranteed with this fuse terminal block (item number 2202-1611/1000-867). Ensure that the strip lengths are between 10 and 12 mm when connecting conductors to this fuse terminal block. This product incorporates conductor terminals and utilizes Push-in CAGE CLAMP®. Push-in CAGE CLAMP® connection technology is ideal for connecting all conductor types. Solid and fine-stranded conductors with ferrules can be pushed in without the need for tools—all thanks to its pluggable design. Depending on the type of conductor, this fuse terminal block is suitable for conductor cross sections ranging from 0.25 mm² to 4 mm².

This product is designed for specific Ex applications (please refer to the product datasheet).

Notes

Safety Information

The 2 mm test slot is only approved for high impedance measurement up to max. 100 mA.

Electrical data

Ratings per	IEC/EN 60947-7-3		
Overvoltage category	III	III	II
Pollution degree	3	2	2
Nominal voltage	250 V	-	-
Rated impulse withstand voltage	6 kV	-	-
Rated current	6.3 A	-	-

Approvals per	UL 1059		
Use group	B	C	D
Rated voltage	120 V	120 V	120 V
Rated current	10 A	10 A	-

Ex information

Reference to hazardous areas	See "Downloads – Documentation – Additional Information: Technical Section; Technical Explanations"
Ratings per	ATEX: PTB 20 ATEX 1007 U / IECEx: PTB 20.0013U (Ex ec IIC Gc)
Rated voltage EN (Ex e II)	275 V
Rated current (Ex e II)	6.3 A

Ratings per IEC/EN – Notes

Ratings (note)	Electrical ratings are given by the fuse and blown fuse indication.
Rated current (note)	Leakage current in case of a blown fuse: LED 2 mA

Approvals per	CSA 22.2 No 158		
Use group	B	C	D
Rated voltage	120 V	120 V	120 V
Rated current	10 A	10 A	10 A

Power Loss

Power loss (max.) $P_{I(max)}$ (note)	When selecting glass cartridge fuses, make sure that the maximum power loss listed below is not exceeded. The power loss is determined according to IEC or EN 60947-7-3/VDE 0611-6 at 23°C. The temperature rise of the terminal block must be checked according to their application and mounting. Higher ambient temperatures represent an additional impact on miniature fuses. Therefore, in such applications, the rated current must be reduced if necessary. More details are available from the manufacturers.
Maximum power loss P_{loss} of fuse insert for overload and short-circuit protection (individual arrangement)	1.6 W
Maximum power loss P_{loss} of fuse insert for overload and short-circuit protection (block arrangement)	1.6 W
Power loss P_I max. short-circuit protection (individual arrangement)	2.5 W
Power loss P_{loss} (max.) of fuse cartridge for short-circuit protection (block arrangement)	2.5 W

General information

Fuse receptacle	pivoting
Fuse type	Cylindrical fuse; 5 x 20 mm
Wiring direction	Front-entry wiring

Connection Data

Clamping units	2
Total number of potentials	1
Number of levels	1
Number of jumper slots	2

Connection 1

Connection technology	Push-in CAGE CLAMP®
Actuation type	Push-button
Connectable conductor materials	Copper
Nominal cross-section	2.5 mm ²
Solid conductor	0.25 ... 4 mm ² / 22 ... 12 AWG
Solid conductor; push-in termination	0.75 ... 4 mm ² / 18 ... 12 AWG
Fine-stranded conductor	0.25 ... 4 mm ² / 22 ... 12 AWG

Connection 1

Fine-stranded conductor; with insulated ferrule	0.25 ... 2.5 mm ² / 22 ... 14 AWG
Fine-stranded conductor; with ferrule; push-in termination	1 ... 2.5 mm ² / 18 ... 14 AWG
Note (conductor cross-section)	Depending on the conductor characteristic, a conductor with a smaller cross-section can also be inserted via push-in termination.
Strip length	10 ... 12 mm / 0.39 ... 0.47 inches
Wiring direction	Front-entry wiring

Physical data

Width	6.2 mm / 0.244 inches
Height	66.1 mm / 2.602 inches
Depth from upper-edge of DIN-rail	57.6 mm / 2.268 inches

Mechanical data

Mounting type	DIN-35 rail
Marking level	Center/side marking

Material data

Note (material data)	Information on material specifications can be found here
Color	gray
Material group	I
Insulation material (main housing)	Polyamide (PA66)
Flammability class per UL94	V0
Fire load	0.305 MJ
Actuator color	orange
Weight	13.8 g

Environmental requirements

Processing temperature	-35 ... +85 °C
Continuous operating temperature	-60 ... +105 °C

Commercial data

PU (SPU)	50 pcs
Packaging type	Box
Country of origin	DE
GTIN	4055143907750
Customs tariff number	85369095000

Product Classification

UNSPSC	39121410
ETIM 9.0	EC000899
ETIM 10.0	EC000899
ECCN	NO US CLASSIFICATION

Environmental Product Compliance

CAS-No.	1303-86-2 1317-36-8 7439-92-1
REACH Candidate List Substance	Diboron trioxide Lead Lead monoxide
RoHS Compliance Status	Compliant,With Exemption
RoHS Exemption	7(c)-I
SCIP notification number (Austria)	0072bb84-849e-4ac2-92d3-b6a08df543ff
SCIP notification number (Belgium)	ec48a01a-f800-43ee-ad9e-66324c259105
SCIP notification number (Bulgaria)	da3cd0a0-3880-439d-9903-2ee5082e2680
SCIP notification number (Czech Republic)	ce3371ea-85ba-4751-a0a3-31681d8cde4e
SCIP notification number (Denmark)	b892f4e2-6f26-40ba-b4e6-85942a0e5919
SCIP notification number (Finland)	1da077f6-54ab-49bc-8161-a1fd5e2fce85
SCIP notification number (France)	ef4f99ce-2b46-48b7-bf93-83751704b0aa
SCIP notification number (Germany)	63be6f46-015f-4b34-b363-0e4cf8639c56
SCIP notification number (Hungary)	33a0169d-566a-4bdb-a8cc-40ffe2370185
SCIP notification number (Italy)	08968ded-dc49-4b49-9632-3e308884360d
SCIP notification number (Netherlands)	c0e089b6-f9f3-4c6e-84c1-9e91762520d1
SCIP notification number (Poland)	54153ab2-452f-4968-b45d-64e681524ed1
SCIP notification number (Romania)	9466ad2a-8739-4e75-928a-83ab80cb26ab
SCIP notification number (Sweden)	cdf14756-36b2-4451-a6fc-29f6c3dafca7

Approvals / Certificates

General approvals



Approval	Standard	Certificate Name
DEKRA DEKRA Certification B.V.	EN 60947	71-147887
UL Underwriters Laboratories Inc.	UL 1059	UL-CA- L45172-6189178-11508102-1

Declarations of conformity and manufacturer's declarations

Approval	Standard	Certificate Name
ATEX-Attestation of Conformity WAGO GmbH & Co. KG	-	-
EU-Declaration of Conformity WAGO GmbH & Co. KG	-	-
UK-Declaration of Conformity WAGO GmbH & Co. KG	-	-

Approvals for hazardous areas

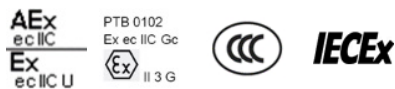

Approval	Standard	Certificate Name
AEx Underwriters Laboratories Inc.	UL 60079	E185892 (AEx eb IIC resp. Ex eb IIC)
ATEX Physikalisch Technische Bundesanstalt	EN IEC 60079-0	PTB 20 ATEX 1007U (II 3 G Ex ec IIC Gc)
CCC CNEX	-	2020312313000288 (Ex ec IIC Gc)
IECEX Physikalisch Technische Bundesanstalt	IEC 60079	IECEX PTB 20.0013U (Ex ec IIC Gc)

Downloads

Environmental Product Compliance

Compliance Search			
Environmental Product Compliance			↓
2202-1611/1000-867			

Documentation

Bid Text			
2202-1611/1000-867	20.05.2019	xml 4.36 KB	↓
2202-1611/1000-867	20.05.2019	docx 15.56 KB	↓

CAD/CAE-Data

CAD data	
2D/3D Models	↓
2202-1611/1000-867	

1 Compatible Products

1.1 Required Accessories

1.1.1 End plate

1.1.1.1 End plate

<p>Item No.: 2002-991 End plate for fuse terminal blocks; 2 mm thick; gray</p>	<p>Item No.: 2002-992 End plate for fuse terminal blocks; 2 mm thick; orange</p>	<p>Item No.: 209-191 Separator for Ex e/Ex i applications; 3 mm thick; 120 mm wide; orange</p>

1.2 Optional Accessories

1.2.1 DIN-rail

1.2.1.1 Mounting accessories

<p>Item No.: 210-196 Aluminum carrier rail; 35 x 8.2 mm; 1.6 mm thick; 2 m long; unslotted; similar to EN 60715; silver-colored</p>	<p>Item No.: 210-198 Copper carrier rail; 35 x 15 mm; 2.3 mm thick; 2 m long; unslotted; according to EN 60715; copper-colored</p>	<p>Item No.: 210-508 Steel carrier rail; 35 x 15 mm; 1.5 mm thick; 2 m long; slotted; galvanized; similar to EN 60715; silver-colored</p>	<p>Item No.: 210-197 Steel carrier rail; 35 x 15 mm; 1.5 mm thick; 2 m long; slotted; similar to EN 60715; silver-colored</p>
<p>Item No.: 210-506 Steel carrier rail; 35 x 15 mm; 1.5 mm thick; 2 m long; unslotted; galvanized; similar to EN 60715; silver-colored</p>	<p>Item No.: 210-114 Steel carrier rail; 35 x 15 mm; 1.5 mm thick; 2 m long; unslotted; similar to EN 60715; silver-colored</p>	<p>Item No.: 210-118 Steel carrier rail; 35 x 15 mm; 2.3 mm thick; 2 m long; unslotted; according to EN 60715; silver-colored</p>	<p>Item No.: 210-115 Steel carrier rail; 35 x 7.5 mm; 1 mm thick; 2 m long; slotted; according to EN 60715; Hole width 18 mm; silver-colored</p>

1.2.1.1 Mounting accessories



Item No.: 210-112

Steel carrier rail; 35 x 7.5 mm; 1 mm thick; 2 m long; slotted; according to EN 60715; Hole width 25 mm; silver-colored

Item No.: 210-504

Steel carrier rail; 35 x 7.5 mm; 1 mm thick; 2 m long; slotted; galvanized; according to EN 60715; silver-colored

Item No.: 210-113

Steel carrier rail; 35 x 7.5 mm; 1 mm thick; 2 m long; unslotted; according to EN 60715; silver-colored

Item No.: 210-505

Steel carrier rail; 35 x 7.5 mm; 1 mm thick; 2 m long; unslotted; galvanized; according to EN 60715; silver-colored

1.2.2 Ferrule

1.2.2.1 Ferrule



Item No.: 216-241

Ferrule; Sleeve for 0.5 mm² / 20 AWG; insulated; electro-tin plated; electrolytic copper; gastight crimped; acc. to DIN 46228, Part 4/09.90; white



Item No.: 216-242

Ferrule; Sleeve for 0.75 mm² / 18 AWG; insulated; electro-tin plated; electrolytic copper; gastight crimped; acc. to DIN 46228, Part 4/09.90; gray



Item No.: 216-262

Ferrule; Sleeve for 0.75 mm² / 18 AWG; insulated; electro-tin plated; electrolytic copper; gastight crimped; acc. to DIN 46228, Part 4/09.90; gray



Item No.: 216-243

Ferrule; Sleeve for 1 mm² / AWG 18; insulated; electro-tin plated; electrolytic copper; gastight crimped; acc. to DIN 46228, Part 4/09.90; red



Item No.: 216-263

Ferrule; Sleeve for 1 mm² / AWG 18; insulated; electro-tin plated; electrolytic copper; gastight crimped; acc. to DIN 46228, Part 4/09.90; red



Item No.: 216-244

Ferrule; Sleeve for 1.5 mm² / AWG 16; insulated; electro-tin plated; electrolytic copper; gastight crimped; acc. to DIN 46228, Part 4/09.90; black



Item No.: 216-264

Ferrule; Sleeve for 1.5 mm² / AWG 16; insulated; electro-tin plated; electrolytic copper; gastight crimped; acc. to DIN 46228, Part 4/09.90; black



Item No.: 216-246

Ferrule; Sleeve for 2.5 mm² / AWG 14; insulated; electro-tin plated; electrolytic copper; gastight crimped; acc. to DIN 46228, Part 4/09.90; blue



Item No.: 216-266

Ferrule; Sleeve for 2.5 mm² / AWG 14; insulated; electro-tin plated; electrolytic copper; gastight crimped; acc. to DIN 46228, Part 4/09.90; blue

1.2.3 Installation

1.2.3.1 Cover



Item No.: 709-156

Cover; Type 3; suitable for cover carrier, type 3; 1 m long; transparent

1.2.3.2 Cover carrier



Item No.: 709-169

Cover carrier; Type 3; incl. fixing/retaining screws and knurled nut; suitable for 279 to 282 and 880 Series rail-mounted terminal blocks; suitable for 264 Series miniature rail-mounted terminal blocks; suitable for 270 Series sensor and actuator terminal blocks; gray

1.2.4 Insulation stop

1.2.4.1 Insulation stop



Item No.: 2002-171

Insulation stop; 0.25 - 0.5 mm²; 5 pieces/strip; light gray



Item No.: 2002-172

Insulation stop; 0.75 - 1 mm²; 5 pieces/strip; dark gray

1.2.5 Jumper

1.2.5.1 Jumper



Item No.: 2004-406/020-000

Delta jumper; insulated; light gray



Item No.: 2004-410

Jumper; 10-way; insulated; light gray



Item No.: 2004-402

Jumper; 2-way; insulated; light gray



Item No.: 2004-403

Jumper; 3-way; insulated; light gray



Item No.: 2004-404

Jumper; 4-way; insulated; light gray



Item No.: 2004-405

Jumper; 5-way; insulated; light gray



Item No.: 2004-406

Jumper; 6-way; insulated; light gray



Item No.: 2004-407

Jumper; 7-way; insulated; light gray



Item No.: 2004-408

Jumper; 8-way; insulated; light gray



Item No.: 2004-409

Jumper; 9-way; insulated; light gray



Item No.: 2004-440

Jumper; from 1 to 10; insulated; light gray



Item No.: 2004-433

Jumper; from 1 to 3; insulated; light gray



Item No.: 2004-434

Jumper; from 1 to 4; insulated; light gray



Item No.: 2004-435

Jumper; from 1 to 5; insulated; light gray



Item No.: 2004-436

Jumper; from 1 to 6; insulated; light gray



Item No.: 2004-437

Jumper; from 1 to 7; insulated; light gray



Item No.: 2004-438

Jumper; from 1 to 8; insulated; light gray



Item No.: 2004-439

Jumper; from 1 to 9; insulated; light gray



Item No.: 2004-405/011-000

Star point jumper; 3-way; insulated; light gray



Item No.: 210-103

Wire commoning chain; insulated; black



Item No.: 210-123

Wire commoning chain; insulated; blue

1.2.6 Locking system

1.2.6.1 Locking system







































Item No.: 210-254

Interlocking link; mechanically locks multiple links; 1 m long; transparent

1.2.7 Marking

1.2.7.1 Marker

<p>Item No.: 2009-145/000-006 Mini-WSB Inline; for Smart Printer; 1700 pieces on roll; stretchable 5 - 5.2 mm; plain; snap-on type; blue</p> 	<p>Item No.: 2009-145/000-007 Mini-WSB Inline; for Smart Printer; 1700 pieces on roll; stretchable 5 - 5.2 mm; plain; snap-on type; gray</p> 	<p>Item No.: 2009-145/000-023 Mini-WSB Inline; for Smart Printer; 1700 pieces on roll; stretchable 5 - 5.2 mm; plain; snap-on type; green</p> 	<p>Item No.: 2009-145/000-012 Mini-WSB Inline; for Smart Printer; 1700 pieces on roll; stretchable 5 - 5.2 mm; plain; snap-on type; orange</p> 
<p>Item No.: 2009-145/000-005 Mini-WSB Inline; for Smart Printer; 1700 pieces on roll; stretchable 5 - 5.2 mm; plain; snap-on type; red</p> 	<p>Item No.: 2009-145/000-024 Mini-WSB Inline; for Smart Printer; 1700 pieces on roll; stretchable 5 - 5.2 mm; plain; snap-on type; violet</p> 	<p>Item No.: 2009-145 Mini-WSB Inline; for Smart Printer; 1700 pieces on roll; stretchable 5 - 5.2 mm; plain; snap-on type; white</p> 	<p>Item No.: 2009-145/000-002 Mini-WSB Inline; for Smart Printer; 1700 pieces on roll; stretchable 5 - 5.2 mm; plain; snap-on type; yellow</p> 
<p>Item No.: 248-501/000-006 Mini-WSB marking card; as card; not stretchable; plain; snap-on type; blue</p> 	<p>Item No.: 248-501/000-007 Mini-WSB marking card; as card; not stretchable; plain; snap-on type; gray</p> 	<p>Item No.: 248-501/000-023 Mini-WSB marking card; as card; not stretchable; plain; snap-on type; green</p> 	<p>Item No.: 248-501/000-017 Mini-WSB marking card; as card; not stretchable; plain; snap-on type; light green</p> 
<p>Item No.: 248-501/000-012 Mini-WSB marking card; as card; not stretchable; plain; snap-on type; orange</p> 	<p>Item No.: 248-501/000-005 Mini-WSB marking card; as card; not stretchable; plain; snap-on type; red</p> 	<p>Item No.: 248-501/000-024 Mini-WSB marking card; as card; not stretchable; plain; snap-on type; violet</p> 	<p>Item No.: 248-501 Mini-WSB marking card; as card; not stretchable; plain; snap-on type; white</p> 
<p>Item No.: 248-501/000-002 Mini-WSB marking card; as card; not stretchable; plain; snap-on type; yellow</p> 	<p>Item No.: 793-5501/000-006 WMB marking card; as card; for terminal block width 5 - 17.5 mm; stretchable 5 - 5.2 mm; plain; snap-on type; blue</p> 	<p>Item No.: 793-5501/000-014 WMB marking card; as card; for terminal block width 5 - 17.5 mm; stretchable 5 - 5.2 mm; plain; snap-on type; brown</p> 	<p>Item No.: 793-5501/000-007 WMB marking card; as card; for terminal block width 5 - 17.5 mm; stretchable 5 - 5.2 mm; plain; snap-on type; gray</p> 
<p>Item No.: 793-5501/000-023 WMB marking card; as card; for terminal block width 5 - 17.5 mm; stretchable 5 - 5.2 mm; plain; snap-on type; green</p> 	<p>Item No.: 793-5501/000-017 WMB marking card; as card; for terminal block width 5 - 17.5 mm; stretchable 5 - 5.2 mm; plain; snap-on type; light green</p> 	<p>Item No.: 793-5501/000-012 WMB marking card; as card; for terminal block width 5 - 17.5 mm; stretchable 5 - 5.2 mm; plain; snap-on type; orange</p> 	<p>Item No.: 793-5501/000-005 WMB marking card; as card; for terminal block width 5 - 17.5 mm; stretchable 5 - 5.2 mm; plain; snap-on type; red</p> 
<p>Item No.: 793-5501/000-024 WMB marking card; as card; for terminal block width 5 - 17.5 mm; stretchable 5 - 5.2 mm; plain; snap-on type; violet</p> 	<p>Item No.: 793-5501 WMB marking card; as card; for terminal block width 5 - 17.5 mm; stretchable 5 - 5.2 mm; plain; snap-on type; white</p> 	<p>Item No.: 793-5501/000-002 WMB marking card; as card; for terminal block width 5 - 17.5 mm; stretchable 5 - 5.2 mm; plain; snap-on type; yellow</p> 	<p>Item No.: 2009-115/000-006 WMB-Inline; for Smart Printer; 1500 pieces on roll; stretchable 5 - 5.2 mm; plain; snap-on type; blue</p> 
<p>Item No.: 2009-115/000-007 WMB-Inline; for Smart Printer; 1500 pieces on roll; stretchable 5 - 5.2 mm; plain; snap-on type; gray</p> 	<p>Item No.: 2009-115/000-023 WMB-Inline; for Smart Printer; 1500 pieces on roll; stretchable 5 - 5.2 mm; plain; snap-on type; green</p> 	<p>Item No.: 2009-115/000-017 WMB-Inline; for Smart Printer; 1500 pieces on roll; stretchable 5 - 5.2 mm; plain; snap-on type; light green</p> 	<p>Item No.: 2009-115/000-012 WMB-Inline; for Smart Printer; 1500 pieces on roll; stretchable 5 - 5.2 mm; plain; snap-on type; orange</p> 
<p>Item No.: 2009-115/000-005 WMB-Inline; for Smart Printer; 1500 pieces on roll; stretchable 5 - 5.2 mm; plain; snap-on type; red</p> 	<p>Item No.: 2009-115/000-024 WMB-Inline; for Smart Printer; 1500 pieces on roll; stretchable 5 - 5.2 mm; plain; snap-on type; violet</p> 	<p>Item No.: 2009-115 WMB-Inline; for Smart Printer; 1500 pieces on roll; stretchable 5 - 5.2 mm; plain; snap-on type; white</p> 	<p>Item No.: 2009-115/000-002 WMB-Inline; for Smart Printer; 1500 pieces on roll; stretchable 5 - 5.2 mm; plain; snap-on type; yellow</p> 

1.2.7.2 Marking strip



Item No.: 2009-110

Marking strips; for Smart Printer; on reel; not stretchable; plain; snap-on type; white

1.2.8 Screwless end stop

1.2.8.1 Mounting accessories



Item No.: 249-117

Screwless end stop; 10 mm wide; for DIN-rail 35 x 15 and 35 x 7.5; gray



Item No.: 249-116

Screwless end stop; 6 mm wide; for DIN-rail 35 x 15 and 35 x 7.5; gray

1.2.9 Test and measurement

1.2.9.1 Testing accessories



Item No.: 210-136

Test plug; 2 mm Ø; with 500 mm cable; red

1.2.10 Tool

1.2.10.1 Operating tool



Item No.: 210-658

Operating tool; Blade: 3.5 x 0.5 mm; with a partially insulated shaft; angled; short; multicoloured



Item No.: 210-720

Operating tool; Blade: 3.5 x 0.5 mm; with a partially insulated shaft; multicoloured

Installation Notes

Conductor termination

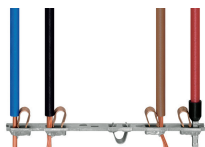

All conductor types at a glance



Push-in termination of solid and ferruled conductors



Push-in termination of solid and ferruled conductors



Insert fine-stranded conductors via operating tool.



Removing all conductors via operating tool.

Commoning

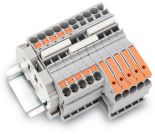

Insert a push-in type jumper bar and push down until it hits the backstop.

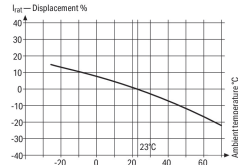
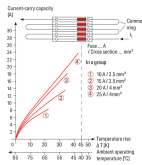
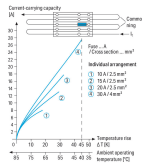

Information from the mini-automotive, blade-type fuse manufacturers

Operating Temp. °C	%	F _I
-25	14	0.877
-15	13	0.866
-5	12	0.855
5	11	0.844
15	10	0.833
25	9	0.822
35	8	0.811
45	7	0.800
55	6	0.789
65	5	0.778
75	4	0.767
85	3	0.756
95	2	0.745
105	1	0.734
115	0	0.723
125	-1	0.712
135	-2	0.701
145	-3	0.690
155	-4	0.679
165	-5	0.668
175	-6	0.657
185	-7	0.646
195	-8	0.635
205	-9	0.624
215	-10	0.613
225	-11	0.602
235	-12	0.591
245	-13	0.580
255	-14	0.569
265	-15	0.558
275	-16	0.547
285	-17	0.536
295	-18	0.525
305	-19	0.514
315	-20	0.503
325	-21	0.492
335	-22	0.481

Application Notes on Terminal Blocks for Glass Cartridge Fuses
Diagram: "Individual Arrangement"

Application Notes on Terminal Blocks for Glass Cartridge Fuses
Diagram: "Block Arrangement"

Application Notes on Terminal Blocks for Glass Cartridge Fuses
Nominal current ratings for fuse cartridges are defined differently in international standards. This is why the recommended continuous current-carrying capacity of the fuses is a max. 80% of their nominal current according to DIN 72581/Part 3 (for a surrounding air temperature of 23°C).
Selecting the correct fuse cartridge is important for product safety within applications, as well as for fuse cartridge service life and reliability. Fuse cartridges will only operate perfectly as protection components (break-off point) if they are properly selected and used as intended (i.e., according to the state of the technology and valid specifications, as well as data sheet characteristics), according to basic safety requirements (i.e., persons, animals and property must be protected against hazards).

Concerning product safety, fuse cartridges must generally be tested under both normal and faulty operating conditions within your application.

Marking

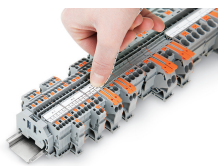

Snapping a marking strip into a marker slot.

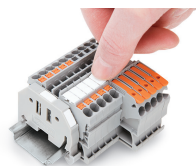

Snapping a marking strip into the marker slot.