

| | |
|----------------|-------------|
| <p>*07 130</p> | |
| <p>*19 377</p> | <p>30mm</p> |
| <p>*46 308</p> | |



DIN EN
806

DIN EN
1717

DIN
1988

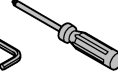
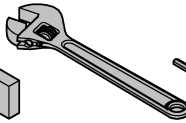
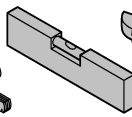
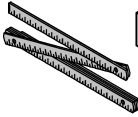
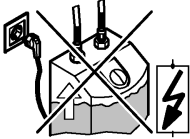
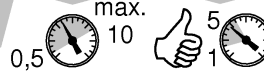

1

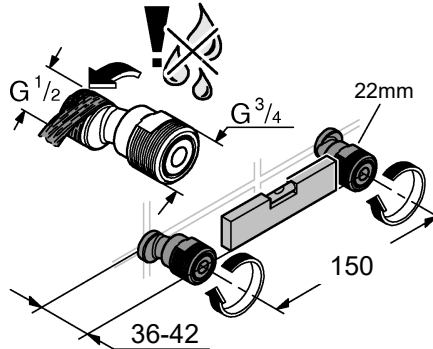
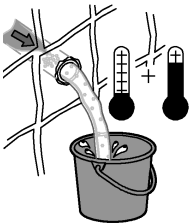

2

