

Data Sheet | Item Number: 2002-1711/1000-541

3-conductor fuse terminal block; with pivoting fuse holder; with end plate; for 5 x 20 mm miniature metric fuse; with blown fuse indication by LED; 12 - 30 V; for DIN-rail 35 x 15 and 35 x 7.5; 2.5 mm²; Push-in CAGE CLAMP®; 2,50 mm²; gray

<https://www.wago.com/2002-1711/1000-541>

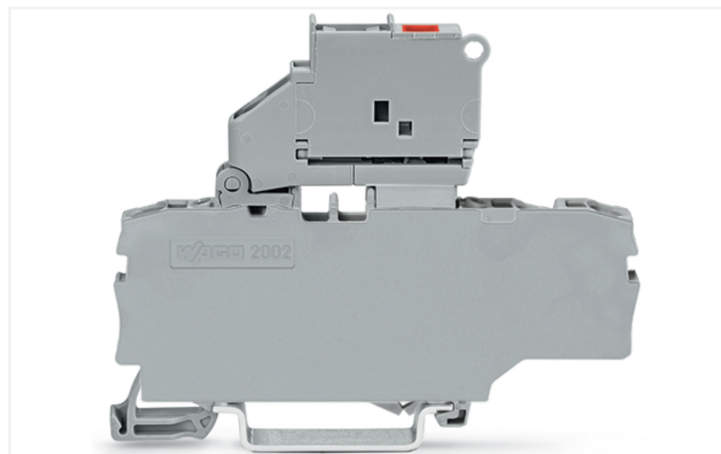
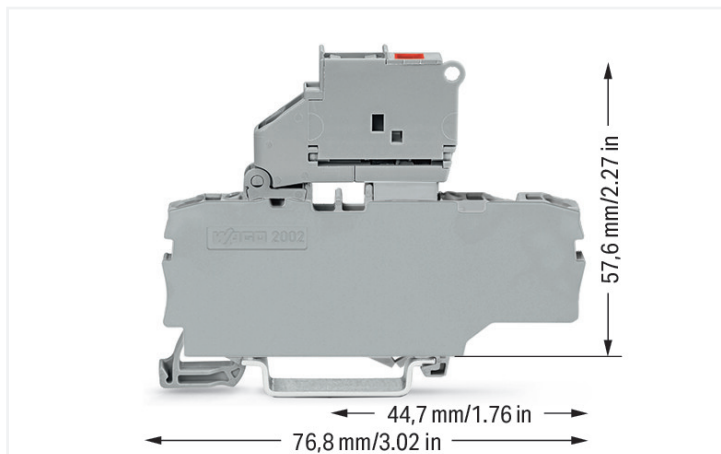

Color: ■ gray

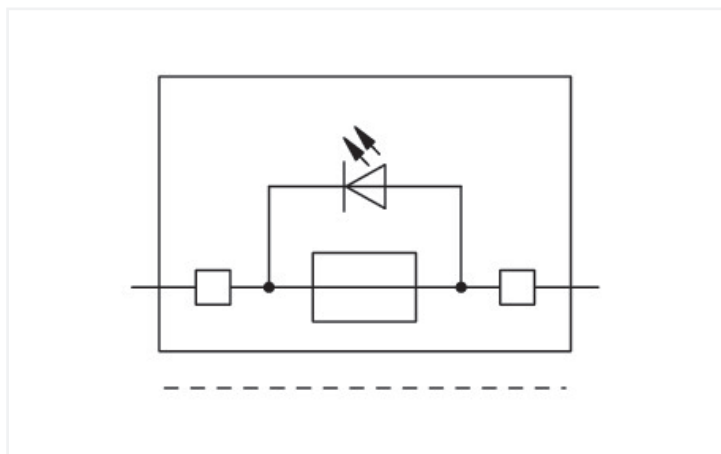

Fuse terminal block, 2002 Series, Push-in CAGE CLAMP®

This fuse terminal block (item number 2002-1711/1000-541) is designed for easy and secure connections. Ensure that the strip lengths are between 10 and 12 mm when connecting conductors to this fuse terminal block. This product features conductor terminals and utilizes Push-in CAGE CLAMP®. Our Push-in CAGE CLAMP® is a universal, maintenance-free connection solution for all conductor types, featuring a winning design: It allows direct insertion of both solid and fine-stranded conductors with ferrules without needing tools. No preparation is required; for example, crimping the conductor's ferrule is not necessary. This fuse terminal block is suitable for conductor cross sections ranging from 0.25 mm² to 4 mm².

This product is designed for specific Ex applications (please refer to the product datasheet).

Notes

Safety Information

The 2 mm test slot is only approved for high impedance measurement up to max. 100 mA.

Electrical data

Ratings per	IEC/EN 60947-7-3		
Overvoltage category	III	III	II
Pollution degree	3	2	2
Nominal voltage	250 V	-	-
Rated impulse withstand voltage	6 kV	-	-
Rated current	6.3 A	-	-

Ratings per	IEC/EN 60947-7-3		
Overvoltage category	III	III	II
Pollution degree	3	2	2
Nominal voltage	30 V	-	-
Rated impulse withstand voltage	0.8 kV	-	-
Rated current	-	-	-

Approvals per	CSA 22.2 No 158		
Use group	B	C	D
Rated voltage	-	30 V	-
Rated current	-	6.3 A	-

Power Loss

Power loss (max.) $P_{I(max)}$ (note)	When selecting glass cartridge fuses, make sure that the maximum power loss listed below is not exceeded. The power loss is determined according to IEC or EN 60947-7-3/VDE 0611-6 at 23°C. The temperature rise of the terminal block must be checked according to their application and mounting. Higher ambient temperatures represent an additional impact on miniature fuses. Therefore, in such applications, the rated current must be reduced if necessary. More details are available from the manufacturers.
Maximum power loss P_{loss} of fuse insert for overload and short-circuit protection (individual arrangement)	1.6 W
Maximum power loss P_{loss} of fuse insert for overload and short-circuit protection (block arrangement)	1.6 W
Power loss $P_{I max}$ short-circuit protection (individual arrangement)	2.5 W
Power loss P_{loss} (max.) of fuse cartridge for short-circuit protection (block arrangement)	2.5 W

Ratings per IEC/EN – Notes

Ratings (note)	Electrical ratings are given by the fuse and blown fuse indication.
Rated current (note)	Leakage current in case of a blown fuse: LED 2.2 mA (at 24 V operating voltage)

Approvals per

	UL 1059		
Use group	B	C	D
Rated voltage	30 V	30 V	30 V
Rated current	10 A	10 A	10 A

Ex information

Reference to hazardous areas	See "Downloads – Documentation – Additional Information: Technical Section; Technical Explanations"
Ratings per	ATEX: KIWA 17 ATEX 0030 U / IECEx: KIWA 17.0014U (Ex ec IIC Gc)
Rated voltage EN (Ex e II)	24 V
Rated current (Ex e II)	6.3 A

General information

Fuse receptacle	pivoting
Fuse type	Cylindrical fuse; 5 x 20 mm
Number/type of diode/LED	Red LED
Wiring direction	Front-entry wiring

Connection Data

Clamping units	3
Total number of potentials	1
Number of levels	1
Number of jumper slots	2

Connection 1

Connection technology	Push-in CAGE CLAMP®
Actuation type	Operating tool
Connectable conductor materials	Copper
Nominal cross-section	2.5 mm ²
Solid conductor	0.25 ... 4 mm ² / 22 ... 12 AWG
Solid conductor; push-in termination	0.75 ... 4 mm ² / 18 ... 12 AWG
Fine-stranded conductor	0.25 ... 4 mm ² / 22 ... 12 AWG
Fine-stranded conductor; with insulated ferrule	0.25 ... 2.5 mm ² / 22 ... 14 AWG
Fine-stranded conductor; with ferrule; push-in termination	1 ... 2.5 mm ² / 18 ... 14 AWG
Note (conductor cross-section)	Depending on the conductor characteristic, a conductor with a smaller cross-section can also be inserted via push-in termination.
Strip length	10 ... 12 mm / 0.39 ... 0.47 inches
Wiring direction	Front-entry wiring

Physical data

Width	6.2 mm / 0.244 inches
Height	76.8 mm / 3.024 inches
Depth from upper-edge of DIN-rail	57.6 mm / 2.268 inches

Mechanical data

Mounting type	DIN-35 rail
Marking level	Center/side marking

Material data

Note (material data)	Information on material specifications can be found here
Color	gray
Material group	I
Insulation material (main housing)	Polyamide (PA66)
Flammability class per UL94	V0
Fire load	0.312 MJ
Weight	14.9 g

Environmental requirements

Ambient temperature (operation)	-35 ... +70 °C
Processing temperature	-35 ... +70 °C
Continuous operating temperature	-35 ... +70 °C

Environmental Testing

Test specification: Railway applications – Rolling stock – Electronic equipment	DIN EN 50155 (VDE 0115-200):2022-06
Test procedure: Railway applications – Rolling stock equipment – Vibration and shock tests	DIN EN 61373 (VDE 0115-0106):2011-04
Spectrum/Mounting location	Service life test, Category 1, Class A/B
Functional test with noise-like oscillations	Test passed according to Section 8 of the standard
Frequency	f ₁ = 5 Hz to f ₂ = 150 Hz
Acceleration	0.101g (highest test level used for all axes)
Test duration per axis	10 min.

Environmental Testing

Test directions	X, Y and Z axes
Monitoring of contact faults and interruptions	Passed
Voltage drop measurement before and after each axis	Passed
Simulated service life test through increased levels of noise-like oscillations	Test passed according to Section 9 of the standard
Frequency	$f_1 = 5 \text{ Hz}$ to $f_2 = 150 \text{ Hz}$
Acceleration	0.572g (highest test level used for all axes)
Test duration per axis	5 h
Test directions	X, Y and Z axes
Extended testing: Monitoring of contact faults and interruptions	Passed
Extended testing: Voltage drop measurement before and after each axis	Passed
Shock test	Test passed according to Section 10 of the standard
Shock pulse form	Half sine
Acceleration	5g (highest test level used for all axes)
Shock duration	30 ms
Number of shocks (per axis)	3 pos. und 3 neg.
Test directions	X, Y and Z axes
Extended testing: Monitoring of contact faults and interruptions	Passed
Extended testing: Voltage drop measurement before and after each axis	Passed
Vibration and shock stress for rolling stock equipment	Passed

Commercial data

PU (SPU)	50 pcs
Packaging type	Box
Country of origin	CN
GTIN	4066966335569
Customs tariff number	85369095000

Product Classification

UNSPSC	39121410
eCl@ss 10.0	27-14-11-16
eCl@ss 9.0	27-14-11-16
ETIM 9.0	EC000899
ETIM 10.0	EC000899
ECCN	NO US CLASSIFICATION

Environmental Product Compliance

CAS-No.	1303-86-2 1317-36-8 7439-92-1
REACH Candidate List Substance	Diboron trioxide Lead Lead monoxide
RoHS Compliance Status	Compliant,With Exemption
RoHS Exemption	7(c)-I
SCIP notification number (Austria)	ca8ab135-6894-467c-8cbc-dec06d1ada57
SCIP notification number (Belgium)	a3f1b070-b0f2-4858-ab31-7d7d5aa7bc40
SCIP notification number (Bulgaria)	e2eba3f2-905c-4ff1-ad2f-e5ea5bddc1eb
SCIP notification number (Czech Republic)	7c0a6226-0dd5-45f0-b96e-c1cee8db9c56

Environmental Product Compliance

SCIP notification number (Denmark)	64b6d666-46f8-4562-a681-1a1e0f421e4e
SCIP notification number (Finland)	3ad88b50-ef5b-45f2-b538-f5260f00baf3
SCIP notification number (France)	e225db5c-0477-4fff-8446-0d6d98677002
SCIP notification number (Germany)	87f3f1b7-5d0d-4d6d-9988-114619cc8a37
SCIP notification number (Hungary)	08c7035b-c1ce-44f4-adae-ed6a3375b6b2
SCIP notification number (Italy)	14da8edf-a354-4d9e-b538-88ccab9d7e31
SCIP notification number (Netherlands)	18045861-ae5-4066-9b80-afb51050c769
SCIP notification number (Poland)	9f76c7b0-3fe3-4aef-a9a7-478480105b5f
SCIP notification number (Romania)	b3a3efa2-4ac8-4bc9-a7d2-1a2a9dc25c68
SCIP notification number (Sweden)	63a3f766-d2ad-4fa2-a690-be2345ef6357

Approvals / Certificates

General approvals



Approval	Standard	Certificate Name
CCA DEKRA Certification B.V.	EN 60947	NTR NL-8054
DEKRA DEKRA Certification B.V.	EN 60947	71-149763
KEMA/KEUR DEKRA Certification B.V.	EN 60947	71-124163
UL Underwriters Laboratories Inc.	UL 1059	E45172

Declarations of conformity and manufacturer's declarations



Approval	Standard	Certificate Name
ATEX-Attestation of Conformity WAGO GmbH & Co. KG	-	-
ATEX-Attestation of Conformity WAGO GmbH & Co. KG	-	-
EU-Declaration of Conformity WAGO GmbH & Co. KG	-	-
Railway WAGO GmbH & Co. KG	-	Railway Ready
UK-Declaration of Conformity WAGO GmbH & Co. KG	-	-

Approvals for marine applications



Approval	Standard	Certificate Name
ABS American Bureau of Shipping	EN 60947	24-0152298-PDA
DNV GL Det Norske Veritas, Germanischer Lloyd	-	TAE00001V2
PRS Polski Rejestr Statków	-	TE/1094/880590/23

Approvals for hazardous areas



Approval	Standard	Certificate Name
AEx Underwriters Laboratories Inc.	UL 60079	E185892 (AEx eb IIC resp. Ex eb IIC)
ATEX KIWA Netherlands B.V.	EN 60079	KIWA 17ATEX0030 U
CCC CNEX	GB/T 3836.3	2020312313000180 (Ex ec IIC Gc)
IECEX KIWA Netherlands B.V.	EN 60079	IECEX KIWA 17.0014U (Ex ec IIC Gc)

Downloads

Environmental Product Compliance

Compliance Search			
Environmental Product Compliance			↓
2002-1711/1000-541			

Documentation

Bid Text			
2002-1711/1000-541	24.04.2019	xml 4.29 KB	↓
2002-1711/1000-541	23.04.2019	docx 15.69 KB	↓

CAD/CAE-Data

CAD data	
2D/3D Models	↓
2002-1711/1000-541	

CAE data	
EPLAN Data Portal	↓
2002-1711/1000-541	
WSCAD Universe	↓
2002-1711/1000-541	
ZUKEN Portal	↓
2002-1711/1000-541	

1 Compatible Products

1.1 Required Accessories

1.1.1 End plate

1.1.1.1 End plate



Item No.: 2002-991
End plate for fuse terminal blocks; 2 mm thick; gray



Item No.: 2002-992
End plate for fuse terminal blocks; 2 mm thick; orange



Item No.: 209-191
Separator for Ex e/Ex i applications; 3 mm thick; 120 mm wide; orange

1.2 Optional Accessories

1.2.1 DIN-rail

1.2.1.1 Mounting accessories



Item No.: 210-196
Aluminum carrier rail; 35 x 8.2 mm; 1.6 mm thick; 2 m long; unslotted; similar to EN 60715; silver-colored



Item No.: 210-198
Copper carrier rail; 35 x 15 mm; 2.3 mm thick; 2 m long; unslotted; according to EN 60715; copper-colored



Item No.: 210-508
Steel carrier rail; 35 x 15 mm; 1.5 mm thick; 2 m long; slotted; galvanized; similar to EN 60715; silver-colored



Item No.: 210-197
Steel carrier rail; 35 x 15 mm; 1.5 mm thick; 2 m long; slotted; similar to EN 60715; silver-colored

1.2.1.1 Mounting accessories



Item No.: 210-506

Steel carrier rail; 35 x 15 mm; 1.5 mm thick; 2 m long; unslotted; galvanized; similar to EN 60715; silver-colored



Item No.: 210-114

Steel carrier rail; 35 x 15 mm; 1.5 mm thick; 2 m long; unslotted; similar to EN 60715; silver-colored



Item No.: 210-118

Steel carrier rail; 35 x 15 mm; 2.3 mm thick; 2 m long; unslotted; according to EN 60715; silver-colored



Item No.: 210-115

Steel carrier rail; 35 x 7.5 mm; 1 mm thick; 2 m long; slotted; according to EN 60715; "Hole width 18 mm; silver-colored



Item No.: 210-112

Steel carrier rail; 35 x 7.5 mm; 1 mm thick; 2 m long; slotted; according to EN 60715; "Hole width 25 mm; silver-colored



Item No.: 210-504

Steel carrier rail; 35 x 7.5 mm; 1 mm thick; 2 m long; slotted; galvanized; according to EN 60715; silver-colored



Item No.: 210-113

Steel carrier rail; 35 x 7.5 mm; 1 mm thick; 2 m long; unslotted; according to EN 60715; silver-colored



Item No.: 210-505

Steel carrier rail; 35 x 7.5 mm; 1 mm thick; 2 m long; unslotted; galvanized; according to EN 60715; silver-colored

1.2.2 Ferrule

1.2.2.1 Ferrule



Item No.: 216-241

Ferrule; Sleeve for 0.5 mm² / 20 AWG; insulated; electro-tin plated; electrolytic copper; gastight crimped; acc. to DIN 46228, Part 4/09.90; white



Item No.: 216-242

Ferrule; Sleeve for 0.75 mm² / 18 AWG; insulated; electro-tin plated; electrolytic copper; gastight crimped; acc. to DIN 46228, Part 4/09.90; gray



Item No.: 216-262

Ferrule; Sleeve for 0.75 mm² / 18 AWG; insulated; electro-tin plated; electrolytic copper; gastight crimped; acc. to DIN 46228, Part 4/09.90; gray



Item No.: 216-243

Ferrule; Sleeve for 1 mm² / AWG 18; insulated; electro-tin plated; electrolytic copper; gastight crimped; acc. to DIN 46228, Part 4/09.90; red



Item No.: 216-263

Ferrule; Sleeve for 1 mm² / AWG 18; insulated; electro-tin plated; electrolytic copper; gastight crimped; acc. to DIN 46228, Part 4/09.90; red



Item No.: 216-244

Ferrule; Sleeve for 1.5 mm² / AWG 16; insulated; electro-tin plated; electrolytic copper; gastight crimped; acc. to DIN 46228, Part 4/09.90; black



Item No.: 216-264

Ferrule; Sleeve for 1.5 mm² / AWG 16; insulated; electro-tin plated; electrolytic copper; gastight crimped; acc. to DIN 46228, Part 4/09.90; black



Item No.: 216-246

Ferrule; Sleeve for 2.5 mm² / AWG 14; insulated; electro-tin plated; electrolytic copper; gastight crimped; acc. to DIN 46228, Part 4/09.90; blue



Item No.: 216-266

Ferrule; Sleeve for 2.5 mm² / AWG 14; insulated; electro-tin plated; electrolytic copper; gastight crimped; acc. to DIN 46228, Part 4/09.90; blue

1.2.3 Installation

1.2.3.1 Cover



Item No.: 709-156

Cover; Type 3; suitable for cover carrier, type 3; 1 m long; transparent

1.2.3.2 Cover carrier



Item No.: 709-169

Cover carrier; Type 3; incl. fixing/retaining screws and knurled nut; suitable for 279 to 282 and 880 Series rail-mounted terminal blocks; suitable for 264 Series miniature rail-mounted terminal blocks; suitable for 270 Series sensor and actuator terminal blocks; gray

1.2.4 Insulation stop

1.2.4.1 Insulation stop



Item No.: 2002-171

Insulation stop; 0.25 - 0.5 mm²; 5 pieces/strip; light gray



Item No.: 2002-172

Insulation stop; 0.75 - 1 mm²; 5 pieces/strip; dark gray

1.2.5 Jumper

1.2.5.1 Jumper



Item No.: 2004-406/020-000

Delta jumper; insulated; light gray



Item No.: 2004-410

Jumper; 10-way; insulated; light gray



Item No.: 2004-402

Jumper; 2-way; insulated; light gray



Item No.: 2004-403

Jumper; 3-way; insulated; light gray



Item No.: 2004-404

Jumper; 4-way; insulated; light gray



Item No.: 2004-405

Jumper; 5-way; insulated; light gray



Item No.: 2004-406

Jumper; 6-way; insulated; light gray



Item No.: 2004-407

Jumper; 7-way; insulated; light gray



Item No.: 2004-408

Jumper; 8-way; insulated; light gray



Item No.: 2004-409

Jumper; 9-way; insulated; light gray



Item No.: 2004-440

Jumper; from 1 to 10; insulated; light gray



Item No.: 2004-433

Jumper; from 1 to 3; insulated; light gray



Item No.: 2004-434

Jumper; from 1 to 4; insulated; light gray



Item No.: 2004-435

Jumper; from 1 to 5; insulated; light gray



Item No.: 2004-436

Jumper; from 1 to 6; insulated; light gray



Item No.: 2004-437

Jumper; from 1 to 7; insulated; light gray



Item No.: 2004-438

Jumper; from 1 to 8; insulated; light gray



Item No.: 2004-439

Jumper; from 1 to 9; insulated; light gray



Item No.: 2004-405/011-000

Star point jumper; 3-way; insulated; light gray



Item No.: 210-103

Wire commoning chain; insulated; black



Item No.: 210-123

Wire commoning chain; insulated; blue

1.2.6 Locking system

1.2.6.1 Locking system







































Item No.: 210-254

Interlocking link; mechanically locks multiple links; 1 m long; transparent

1.2.7 Marking

1.2.7.1 Marker

<p>Item No.: 2009-145/000-006 Mini-WSB Inline; for Smart Printer; 1700 pieces on roll; stretchable 5 - 5.2 mm; plain; snap-on type; blue</p> 	<p>Item No.: 2009-145/000-007 Mini-WSB Inline; for Smart Printer; 1700 pieces on roll; stretchable 5 - 5.2 mm; plain; snap-on type; gray</p> 	<p>Item No.: 2009-145/000-023 Mini-WSB Inline; for Smart Printer; 1700 pieces on roll; stretchable 5 - 5.2 mm; plain; snap-on type; green</p> 	<p>Item No.: 2009-145/000-012 Mini-WSB Inline; for Smart Printer; 1700 pieces on roll; stretchable 5 - 5.2 mm; plain; snap-on type; orange</p> 
<p>Item No.: 2009-145/000-005 Mini-WSB Inline; for Smart Printer; 1700 pieces on roll; stretchable 5 - 5.2 mm; plain; snap-on type; red</p> 	<p>Item No.: 2009-145/000-024 Mini-WSB Inline; for Smart Printer; 1700 pieces on roll; stretchable 5 - 5.2 mm; plain; snap-on type; violet</p> 	<p>Item No.: 2009-145 Mini-WSB Inline; for Smart Printer; 1700 pieces on roll; stretchable 5 - 5.2 mm; plain; snap-on type; white</p> 	<p>Item No.: 2009-145/000-002 Mini-WSB Inline; for Smart Printer; 1700 pieces on roll; stretchable 5 - 5.2 mm; plain; snap-on type; yellow</p> 
<p>Item No.: 248-501/000-006 Mini-WSB marking card; as card; not stretchable; plain; snap-on type; blue</p> 	<p>Item No.: 248-501/000-007 Mini-WSB marking card; as card; not stretchable; plain; snap-on type; gray</p> 	<p>Item No.: 248-501/000-023 Mini-WSB marking card; as card; not stretchable; plain; snap-on type; green</p> 	<p>Item No.: 248-501/000-017 Mini-WSB marking card; as card; not stretchable; plain; snap-on type; light green</p> 
<p>Item No.: 248-501/000-012 Mini-WSB marking card; as card; not stretchable; plain; snap-on type; orange</p> 	<p>Item No.: 248-501/000-005 Mini-WSB marking card; as card; not stretchable; plain; snap-on type; red</p> 	<p>Item No.: 248-501/000-024 Mini-WSB marking card; as card; not stretchable; plain; snap-on type; violet</p> 	<p>Item No.: 248-501 Mini-WSB marking card; as card; not stretchable; plain; snap-on type; white</p> 
<p>Item No.: 248-501/000-002 Mini-WSB marking card; as card; not stretchable; plain; snap-on type; yellow</p> 	<p>Item No.: 793-5501/000-006 WMB marking card; as card; for terminal block width 5 - 17.5 mm; stretchable 5 - 5.2 mm; plain; snap-on type; blue</p> 	<p>Item No.: 793-5501/000-014 WMB marking card; as card; for terminal block width 5 - 17.5 mm; stretchable 5 - 5.2 mm; plain; snap-on type; brown</p> 	<p>Item No.: 793-5501/000-007 WMB marking card; as card; for terminal block width 5 - 17.5 mm; stretchable 5 - 5.2 mm; plain; snap-on type; gray</p> 
<p>Item No.: 793-5501/000-023 WMB marking card; as card; for terminal block width 5 - 17.5 mm; stretchable 5 - 5.2 mm; plain; snap-on type; green</p> 	<p>Item No.: 793-5501/000-017 WMB marking card; as card; for terminal block width 5 - 17.5 mm; stretchable 5 - 5.2 mm; plain; snap-on type; light green</p> 	<p>Item No.: 793-5501/000-012 WMB marking card; as card; for terminal block width 5 - 17.5 mm; stretchable 5 - 5.2 mm; plain; snap-on type; orange</p> 	<p>Item No.: 793-5501/000-005 WMB marking card; as card; for terminal block width 5 - 17.5 mm; stretchable 5 - 5.2 mm; plain; snap-on type; red</p> 
<p>Item No.: 793-5501/000-024 WMB marking card; as card; for terminal block width 5 - 17.5 mm; stretchable 5 - 5.2 mm; plain; snap-on type; violet</p> 	<p>Item No.: 793-5501 WMB marking card; as card; for terminal block width 5 - 17.5 mm; stretchable 5 - 5.2 mm; plain; snap-on type; white</p> 	<p>Item No.: 793-5501/000-002 WMB marking card; as card; for terminal block width 5 - 17.5 mm; stretchable 5 - 5.2 mm; plain; snap-on type; yellow</p> 	<p>Item No.: 2009-115/000-006 WMB-Inline; for Smart Printer; 1500 pieces on roll; stretchable 5 - 5.2 mm; plain; snap-on type; blue</p> 
<p>Item No.: 2009-115/000-007 WMB-Inline; for Smart Printer; 1500 pieces on roll; stretchable 5 - 5.2 mm; plain; snap-on type; gray</p> 	<p>Item No.: 2009-115/000-023 WMB-Inline; for Smart Printer; 1500 pieces on roll; stretchable 5 - 5.2 mm; plain; snap-on type; green</p> 	<p>Item No.: 2009-115/000-017 WMB-Inline; for Smart Printer; 1500 pieces on roll; stretchable 5 - 5.2 mm; plain; snap-on type; light green</p> 	<p>Item No.: 2009-115/000-012 WMB-Inline; for Smart Printer; 1500 pieces on roll; stretchable 5 - 5.2 mm; plain; snap-on type; orange</p> 
<p>Item No.: 2009-115/000-005 WMB-Inline; for Smart Printer; 1500 pieces on roll; stretchable 5 - 5.2 mm; plain; snap-on type; red</p> 	<p>Item No.: 2009-115/000-024 WMB-Inline; for Smart Printer; 1500 pieces on roll; stretchable 5 - 5.2 mm; plain; snap-on type; violet</p> 	<p>Item No.: 2009-115 WMB-Inline; for Smart Printer; 1500 pieces on roll; stretchable 5 - 5.2 mm; plain; snap-on type; white</p> 	<p>Item No.: 2009-115/000-002 WMB-Inline; for Smart Printer; 1500 pieces on roll; stretchable 5 - 5.2 mm; plain; snap-on type; yellow</p> 

1.2.7.2 Marking strip



Item No.: 2009-110

Marking strips; for Smart Printer; on reel; not stretchable; plain; snap-on type; white

1.2.8 Protective warning marker

1.2.8.1 Cover



Item No.: 2002-115

Protective warning marker; for 5 terminal blocks; with high-voltage symbol, black; yellow

1.2.9 Screwless end stop

1.2.9.1 Mounting accessories



Item No.: 249-117

Screwless end stop; 10 mm wide; for DIN-rail 35 x 15 and 35 x 7.5; gray



Item No.: 249-116

Screwless end stop; 6 mm wide; for DIN-rail 35 x 15 and 35 x 7.5; gray

1.2.10 Test and measurement

1.2.10.1 Testing accessories



Item No.: 210-136

Test plug; 2 mm Ø; with 500 mm cable; red

1.2.11 Tool

1.2.11.1 Operating tool



Item No.: 210-658

Operating tool; Blade: 3.5 x 0.5 mm; with a partially insulated shaft; angled; short; multicoloured



Item No.: 210-720

Operating tool; Blade: 3.5 x 0.5 mm; with a partially insulated shaft; multicoloured

Installation Notes

Conductor termination

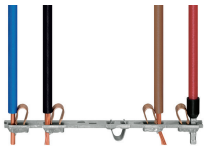

All conductor types at a glance

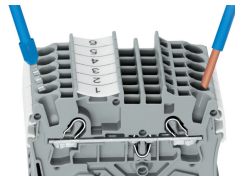

Push-in termination of solid and ferruled conductors

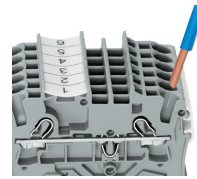

Inserting a conductor via push-in termination:
Solid conductors with cross-sections from either one size above, or up to two sizes below, the rated cross-section can be simply pushed in – no tools needed.

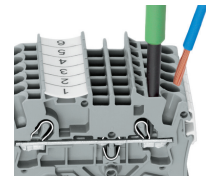

Inserting a conductor via operating tool:
Connecting fine-stranded conductors without ferrules, or small cross-sectional conductors that cannot be pushed in, is performed similarly to the original CAGE CLAMP® – just use an operating tool.
Advantage:
To open the clamp, the operating tool is inserted vertically. The conductor entry is less than 15 degrees for easier wiring.

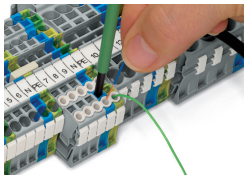

Conductor termination – insulation stop

Commoning

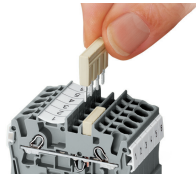

Insert push-in type jumper bar and push down until it hits backstop.

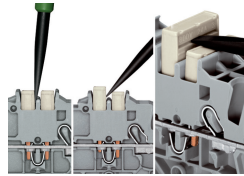

Removing a push-in type jumper bar:
Insert the operating tool between the jumper and partition wall of the dual jumper slots, then lift up the jumper.
Place the operating tool in the center of jumpers for up to five contacts (see above), or alternately on both sides for jumpers with more than five contacts.



Fuse terminal blocks with a width of 6.2 mm/0.244 in can be assembled adjacently. If there is no adjacent fuse terminal block at the end of the assembly, an end plate must be used.

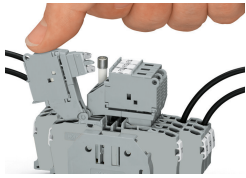

Fused Disconnect Terminal Block with a Pivoting Fuse Holder
Pivot the fuse holder into the locked open position.

Fused disconnect terminal block with a pivoting fuse holder
Fuse replacement

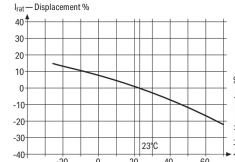
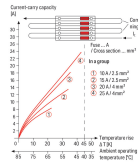
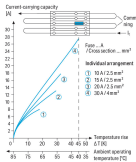

Information from the mini-automotive, blade-type fuse manufacturers

Operating Temp/°C	%	F _I
15	14	0.877
10	13	0.866
-15	12	0.859
-30	11	0.854
-45	10	0.851
-60	9	0.849
-75	8	0.848
-90	7	0.848
-105	6	0.848
-120	5	0.848
-135	4	0.848
-150	3	0.848
-165	2	0.848
-180	1	0.848
-195	0	0.848
-210	-1	0.848
-225	-2	0.848

Application Notes on Terminal Blocks for Glass Cartridge Fuses
Diagram: "Individual Arrangement"

Application Notes on Terminal Blocks for Glass Cartridge Fuses
Diagram: "Block Arrangement"

Application Notes on Terminal Blocks for Glass Cartridge Fuses
Nominal current ratings for fuse cartridges are defined differently in international standards. This is why the recommended continuous current-carrying capacity of the fuses is a max. 80% of their nominal current according to DIN 72581/Part 3 (for a surrounding air temperature of 23°C).
Selecting the correct fuse cartridge is important for product safety within applications, as well as for fuse cartridge service life and reliability. Fuse cartridges will only operate perfectly as protection components (break-off point) if they are properly selected and used as intended (i.e., according to the state of the technology and valid specifications, as well as data sheet characteristics), according to basic safety requirements (i.e., persons, animals and property must be protected against hazards).

Concerning product safety, fuse cartridges must generally be tested under both normal and faulty operating conditions within your application.

Marking

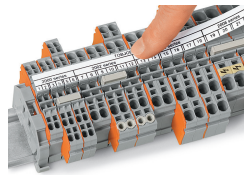
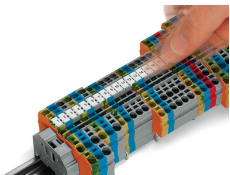

Snapping WMB Inline markers into marker slots.