











Handle for 2-way/3-way diverter Neutral Ø 72 x 55 mm - Champagne (22kt Gold)

SPARE PARTS

90 20 80 014 01 Product version from 4/1/2025



	Champagne (22kt Gold)	90 20 80 014 01-47
	Chrome	90 20 80 014 01-00
	Brushed Platinum	90 20 80 014 01-06
	Platinum	90 20 80 014 01-08
	Dark Chrome	90 20 80 014 01-19
	Brushed Light Gold (PVD)	90 20 80 014 01-27
	Brushed Durabronze (23kt Gold)	90 20 80 014 01-28
	Brushed Dark Brass (PVD)	90 20 80 014 01-39
	Brushed Champagne (22kt Gold)	90 20 80 014 01-46
	Brushed Dark Platinum	90 20 80 014 01-99



Handle for 2-way/3-way diverter Neutral Ø 72 x 55 mm - Champagne (22kt Gold)

SPARE PARTS

90 20 80 014 01 Product version from 4/1/2025



Handle for 2-way/3-way diverter Neutral Ø 72 x 55 mm - Champagne (22kt Gold)

SPARE PARTS

90 20 80 014 01 Product version from 4/1/2025

90 20 80 014 01 Product version from 4/1/2025

Parts for other finishes can be found here: Chrome

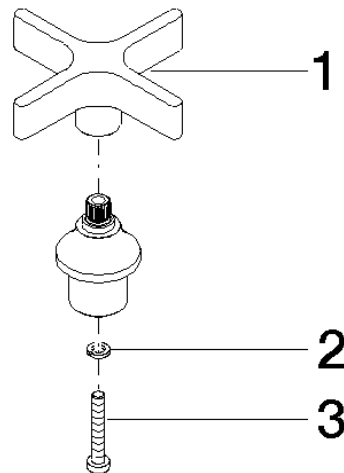

Spare parts list

No.	Item Number	Name	Quantity used	Delivery time
2	90 30 11 029 00 90	Connection Spring lock washer Ø 4 -	1.00	14
3	09 30 30 084 90	Mounting Cylinder head screw with hexagon socket Low profile M4 x 25 mm -	1.00	14
1	90 20 80 061 00-47	handle	1.00	-

Spare part can no longer be ordered, please order the replacement item