

Data Sheet | Item Number: 2007-8801/046-000

2-conductor through terminal block; 6 mm²; with touch-proof test socket; for 4 mm Ø test plugs; side and center marking; for DIN-rail 35 x 15 and 35 x 7.5; Push-in CAGE CLAMP®; 6,00 mm²; gray

<https://www.wago.com/2007-8801/046-000>

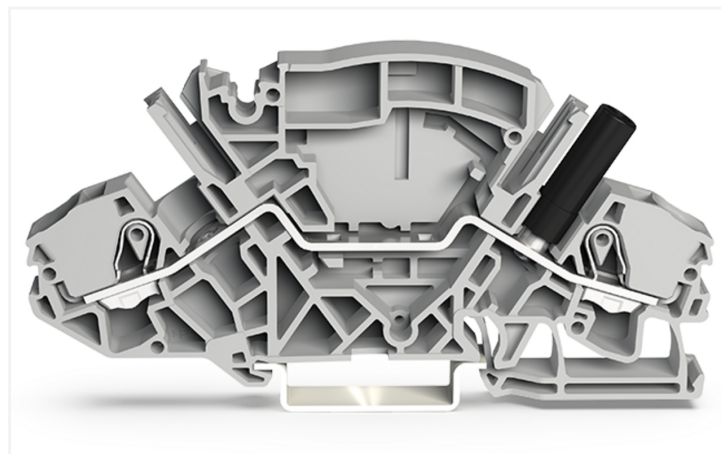
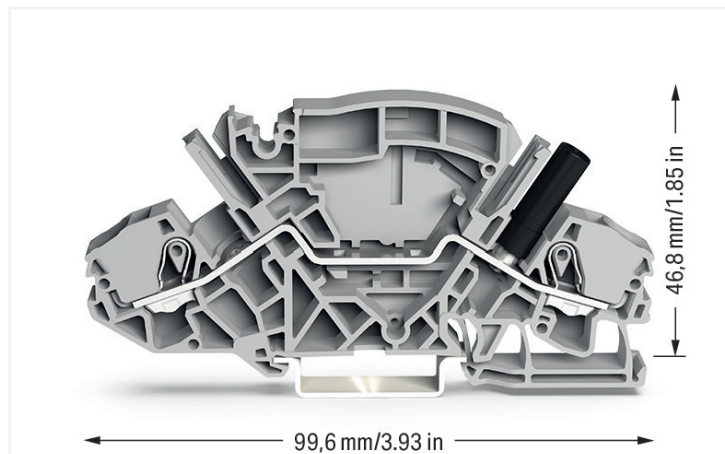

Color: ■ gray

Through terminal block, 2007 Series, operating tool

Easily, quickly and safely connect conductors with this through terminal block (item number 2007-8801/046-000). Ensure that the strip lengths are between 13 and 15 mm when connecting conductors to this through terminal block. This product incorporates conductor terminals and utilizes Push-in CAGE CLAMP®. Push-in CAGE CLAMP® technology provides a universal connection solution for all conductor types. It allows both solid and fine-stranded conductors with ferrules to be inserted directly into the clamping point without the need for tools. This through terminal block is suitable for conductor cross sections ranging from 0.5 mm² to 10 mm².

Electrical data

Ratings per	IEC/EN 60664-1		
Overvoltage category	III	III	II
Pollution degree	3	2	2
Nominal voltage	500 V	-	-
Rated impulse withstand voltage	6 kV	-	-
Rated current	30 A	-	-

Approvals per	UL 1059		
Use group	B	C	D
Rated voltage	300 V	300 V	300 V
Rated current	30 A	30 A	10 A

Approvals per	CSA 22.2 No 158		
Use group	B	C	D
Rated voltage	300 V	300 V	300 V
Rated current	30 A	30 A	10 A

Power Loss	
Power loss, per pole (potential)	0.702 W
Rated current I_N for power loss specification	30 A
Resistance value for specified, current-dependent power loss	0.00078 Ω

General information

Wiring direction	Front-entry wiring
------------------	--------------------

Connection Data

Clamping units	2
Total number of potentials	1
Number of levels	1
Number of jumper slots	2

Connection 1

Connection technology	Push-in CAGE CLAMP®
Actuation type	Operating tool
Connectable conductor materials	Copper
Nominal cross-section	6 mm ² / 10 AWG
Solid conductor	0.5 ... 10 mm ² / 20 ... 8 AWG
Solid conductor; push-in termination	1 ... 10 mm ² / 14 ... 8 AWG
Fine-stranded conductor	0.5 ... 10 mm ² / 20 ... 8 AWG
Fine-stranded conductor; with insulated ferrule	0.5 ... 6 mm ² / 20 ... 10 AWG
Fine-stranded conductor; with uninsulated ferrule	1.5 ... 6 mm ² / 16 ... 10 AWG
Fine-stranded conductor; with ferrule; push-in termination	2.5 ... 6 mm ² / 16 ... 10 AWG
Strip length	13 ... 15 mm / 0.51 ... 0.59 inches
Wiring direction	Front-entry wiring

Physical data

Width	8 mm / 0.315 inches
Height	99.6 mm / 3.921 inches
Depth from upper-edge of DIN-rail	46.8 mm / 1.843 inches

Mechanical data

Mounting type	DIN-35 rail
Marking level	Center/side marking

Material data

Note (material data)	Information on material specifications can be found here
Color	gray
Material group	I
Insulation material (main housing)	Polyamide (PA66)
Flammability class per UL94	V0
Fire load	0.388 MJ
Weight	22 g
Test socket color	black

Environmental requirements

Processing temperature	-35 ... +85 °C
Continuous operating temperature	-60 ... +105 °C

Environmental Testing

Test specification: Railway applications – Rolling stock – Electronic equipment	DIN EN 50155 (VDE 0115-200):2022-06
Test procedure: Railway applications – Rolling stock equipment – Vibration and shock tests	DIN EN 61373 (VDE 0115-0106):2011-04
Spectrum/Mounting location	Service life test, Category 1, Class A/B
Functional test with noise-like oscillations	Test passed according to Section 8 of the standard
Frequency	f ₁ = 5 Hz to f ₂ = 150 Hz
Acceleration	0.101g (highest test level used for all axes)
Test duration per axis	10 min.

Environmental Testing

Test directions	X, Y and Z axes
Monitoring of contact faults and interruptions	Passed
Voltage drop measurement before and after each axis	Passed
Simulated service life test through increased levels of noise-like oscillations	Test passed according to Section 9 of the standard
Frequency	$f_1 = 5 \text{ Hz}$ to $f_2 = 150 \text{ Hz}$
Acceleration	0.572g (highest test level used for all axes)
Test duration per axis	5 h
Test directions	X, Y and Z axes
Extended testing: Monitoring of contact faults and interruptions	Passed
Extended testing: Voltage drop measurement before and after each axis	Passed
Shock test	Test passed according to Section 10 of the standard
Shock pulse form	Half sine
Acceleration	5g (highest test level used for all axes)
Shock duration	30 ms
Number of shocks (per axis)	3 pos. und 3 neg.
Test directions	X, Y and Z axes
Extended testing: Monitoring of contact faults and interruptions	Passed
Extended testing: Voltage drop measurement before and after each axis	Passed
Vibration and shock stress for rolling stock equipment	Passed

Commercial data

PU (SPU)	20 pcs
Packaging type	Box
Country of origin	CN
GTIN	4055143394840
Customs tariff number	85369010000

Product Classification

UNSPSC	39121410
eCl@ss 10.0	27-14-11-20
eCl@ss 9.0	27-14-11-20
ETIM 9.0	EC000897
ETIM 10.0	EC000897
ECCN	NO US CLASSIFICATION

Environmental Product Compliance

CAS-No.	7439-92-1
REACH Candidate List Substance	Lead
RoHS Compliance Status	Compliant,With Exemption
RoHS Exemption	6(c)
SCIP notification number (Austria)	1e914bbc-e753-4d81-955a-de64d61a89e5
SCIP notification number (Belgium)	914de109-72b0-4546-a575-6409880fbb6e
SCIP notification number (Bulgaria)	026d7abb-995f-48df-8c25-4e70e13d6abb
SCIP notification number (Czech Republic)	6cb99b42-ecb7-4ef9-a7cd-8c1818fc21cd
SCIP notification number (Denmark)	c1a9a559-12b4-46d7-8c5c-4ab1fa40e7ac
SCIP notification number (Finland)	522fd2a2-adf1-4ab4-a841-ef48ecfb672c
SCIP notification number (France)	29965a7c-d134-4827-9ae6-ce83e402ba6e

Environmental Product Compliance

SCIP notification number (Germany)	c3a764c6-c832-493a-883a-1cf52965345a
SCIP notification number (Hungary)	cd7b1535-0ade-4c27-8f7d-c772e7b2b0a2
SCIP notification number (Italy)	ca9bfe48-13e0-4f1e-a8a6-f324d5366d35
SCIP notification number (Netherlands)	aa99d053-1ad2-412f-b780-04bcfa2dd4b2
SCIP notification number (Poland)	fd9021da-187d-452a-b8f3-d08fb8ec6370
SCIP notification number (Romania)	b9f62c84-8f13-4532-872e-bb0e7b70e96b
SCIP notification number (Sweden)	75253a32-653a-4d94-9e7e-a181dbf17284

Approvals / Certificates

General approvals

Declarations of conformity and manufacturer's declarations



Approval	Standard	Certificate Name
CSA DEKRA Certification B.V.	C22.2 No. 158	70009679
KEMA/KEUR DEKRA Certification B.V.	EN 60947	71-131652
UL UL International Germany GmbH	UL 1059	E45172

Approval	Standard	Certificate Name
EU-Declaration of Conformity WAGO GmbH & Co. KG	-	-
Railway WAGO GmbH & Co. KG	-	Railway Ready
UK-Declaration of Conformity WAGO GmbH & Co. KG	-	-

Approvals for marine applications



Approval	Standard	Certificate Name
DNV GL Det Norske Veritas, Germanischer Lloyd	-	TAE00001V2
PRS Polski Rejestr Statków	-	TE/1094/880590/23

Downloads

Environmental Product Compliance

Compliance Search

Environmental Product Compliance 2007-8801/046-000	↓
---	---

CAD/CAE-Data

CAD data	CAE data
2D/3D Models 2007-8801/046-000	EPLAN Data Portal 2007-8801/046-000
	WSCAD Universe 2007-8801/046-000
	ZUKEN Portal 2007-8801/046-000

1 Compatible Products

1.1 Required Accessories

1.1.1 End plate

1.1.1.1 End plate



Item No.: 2007-8893 End plate; 1.5 mm thick; with lock-out seal option; gray	Item No.: 2007-8894 End plate; 1.5 mm thick; with lock-out seal option; orange	Item No.: 2007-8891 End plate; 1.5 mm thick; without lock-out seal option; gray	Item No.: 2007-8892 End plate; 1.5 mm thick; without lock-out seal option; orange
---	---	--	--

1.2 Optional Accessories

1.2.1 DIN-rail

1.2.1.1 Mounting accessories



Item No.: 210-196 Aluminum carrier rail; 35 x 8.2 mm; 1.6 mm thick; 2 m long; unslotted; similar to EN 60715; silver-colored	Item No.: 210-198 Copper carrier rail; 35 x 15 mm; 2.3 mm thick; 2 m long; unslotted; according to EN 60715; copper-colored	Item No.: 210-197 Steel carrier rail; 35 x 15 mm; 1.5 mm thick; 2 m long; slotted; similar to EN 60715; silver-colored	Item No.: 210-114 Steel carrier rail; 35 x 15 mm; 1.5 mm thick; 2 m long; unslotted; similar to EN 60715; silver-colored
Item No.: 210-118 Steel carrier rail; 35 x 15 mm; 2.3 mm thick; 2 m long; unslotted; according to EN 60715; silver-colored	Item No.: 210-115 Steel carrier rail; 35 x 7.5 mm; 1 mm thick; 2 m long; slotted; according to EN 60715; "Hole width 18 mm; silver-colored	Item No.: 210-112 Steel carrier rail; 35 x 7.5 mm; 1 mm thick; 2 m long; slotted; according to EN 60715; "Hole width 25 mm; silver-colored	Item No.: 210-113 Steel carrier rail; 35 x 7.5 mm; 1 mm thick; 2 m long; unslotted; according to EN 60715; silver-colored

1.2.2 Installation

1.2.2.1 Cover



Item No.: 709-156 Cover; Type 3; suitable for cover carrier, type 3; 1 m long; transparent

1.2.2.2 Cover carrier



Item No.: 709-169

Cover carrier; Type 3; incl. fixing/retaining screws and knurled nut; suitable for 279 to 282 and 880 Series rail-mounted terminal blocks; suitable for 264 Series miniature rail-mounted terminal blocks; suitable for 270 Series sensor and actuator terminal blocks; gray

1.2.3 Jumper

1.2.3.1 Jumper



Item No.: 282-440

Jumper; 10-way; insulated; orange



Item No.: 282-432

Jumper; 2-way; insulated; orange



Item No.: 282-432/100-000

Jumper; 2-way; insulated; orange



Item No.: 282-433

Jumper; 3-way; insulated; orange



Item No.: 282-433/100-000

Jumper; 3-way; insulated; orange



Item No.: 282-434

Jumper; 4-way; insulated; orange



Item No.: 282-434/100-000

Jumper; 4-way; insulated; orange



Item No.: 282-435

Jumper; 5-way; insulated; orange



Item No.: 282-436

Jumper; 6-way; insulated; orange



Item No.: 282-437

Jumper; 7-way; insulated; orange



Item No.: 282-438

Jumper; 8-way; insulated; orange



Item No.: 282-439

Jumper; 9-way; insulated; orange



Item No.: 282-435/011-000

Jumper; insulated; orange



Item No.: 282-435/300-000

Jumper; insulated; orange



Item No.: 282-435/301-000

Jumper; insulated; orange



Item No.: 282-436/301-000

Jumper; insulated; orange



Item No.: 282-436/304-000

Jumper; insulated; orange



Item No.: 282-437/011-000

Jumper; insulated; orange



Item No.: 282-437/012-000

Jumper; insulated; orange



Item No.: 282-438/300-000

Jumper; insulated; orange



Item No.: 282-438/301-000

Jumper; insulated; orange



Item No.: 282-439/011-000

Jumper; insulated; orange

1.2.4 Marking

1.2.4.1 Marker



Item No.: 793-501/000-006

WMB marking card; as card; not stretchable; plain; snap-on type; blue



Item No.: 793-501/000-007

WMB marking card; as card; not stretchable; plain; snap-on type; gray



Item No.: 793-501/000-023

WMB marking card; as card; not stretchable; plain; snap-on type; green



Item No.: 793-501/000-017

WMB marking card; as card; not stretchable; plain; snap-on type; light green



Item No.: 793-501/000-012

WMB marking card; as card; not stretchable; plain; snap-on type; orange



Item No.: 793-501/000-005

WMB marking card; as card; not stretchable; plain; snap-on type; red



Item No.: 793-501/000-024

WMB marking card; as card; not stretchable; plain; snap-on type; violet



Item No.: 793-501

WMB marking card; as card; not stretchable; plain; snap-on type; white



Item No.: 793-501/000-002

WMB marking card; as card; not stretchable; plain; snap-on type; yellow



Item No.: 2009-115/000-006

WMB-Inline; for Smart Printer; 1500 pieces on roll; stretchable 5 - 5.2 mm; plain; snap-on type; blue



Item No.: 2009-115/000-007

WMB-Inline; for Smart Printer; 1500 pieces on roll; stretchable 5 - 5.2 mm; plain; snap-on type; gray



Item No.: 2009-115/000-023

WMB-Inline; for Smart Printer; 1500 pieces on roll; stretchable 5 - 5.2 mm; plain; snap-on type; green

1.2.4.1 Marker



Item No.: 2009-115/000-017

WMB-Inline; for Smart Printer; 1500 pieces on roll; stretchable 5 - 5.2 mm; plain; snap-on type; light green



Item No.: 2009-115/000-012

WMB-Inline; for Smart Printer; 1500 pieces on roll; stretchable 5 - 5.2 mm; plain; snap-on type; orange



Item No.: 2009-115/000-024

WMB-Inline; for Smart Printer; 1500 pieces on roll; stretchable 5 - 5.2 mm; plain; snap-on type; violet



Item No.: 2009-115

WMB-Inline; for Smart Printer; 1500 pieces on roll; stretchable 5 - 5.2 mm; plain; snap-on type; white



Item No.: 2009-115/000-002

WMB-Inline; for Smart Printer; 1500 pieces on roll; stretchable 5 - 5.2 mm; plain; snap-on type; yellow

1.2.4.2 Marker carrier



Item No.: 2009-198

Adaptor; gray

1.2.4.3 Marking strip



Item No.: 2009-110

Marking strips; for Smart Printer; on reel; not stretchable; plain; snap-on type; white

1.2.5 Protective warning marker

1.2.5.1 Cover



Item No.: 2006-115

Protective warning marker; for 5 terminal blocks; with high-voltage symbol, black; yellow

1.2.6 Screwless end stop

1.2.6.1 Mounting accessories



Item No.: 249-117

Screwless end stop; 10 mm wide; for DIN-rail 35 x 15 and 35 x 7.5; gray



Item No.: 249-116

Screwless end stop; 6 mm wide; for DIN-rail 35 x 15 and 35 x 7.5; gray

1.2.7 Tool

1.2.7.1 Operating tool



Item No.: 210-721

Operating tool; Blade: 5.5 x 0.8 mm; with a partially insulated shaft; multicoloured

Installation Notes

Commoning

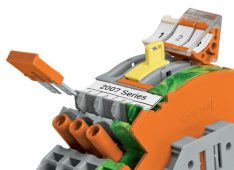

Additional commoning option on the transformer side

Security

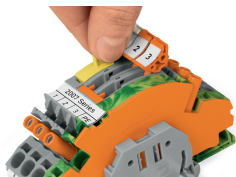

Lock-out prevents accidental operation of disconnect link.

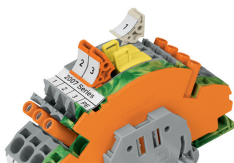

Lock-out snaps into one of two notched positions.

Locking system



Using locking covers or profiles for adjacent terminal blocks allows disconnect links to be operated simultaneously.

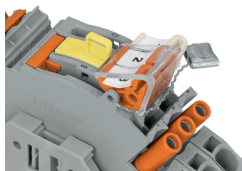

A lock-out seal can be used on the disconnect link in operating position I when combined with an end and separator plate (Item No. 2007-8893 or Item No. 2007-8894).



Interlocking link mechanically locks multiple links for multi-pole switching applications.

Marking

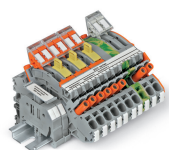

Marking via WMB Multi markers or marking strips.