

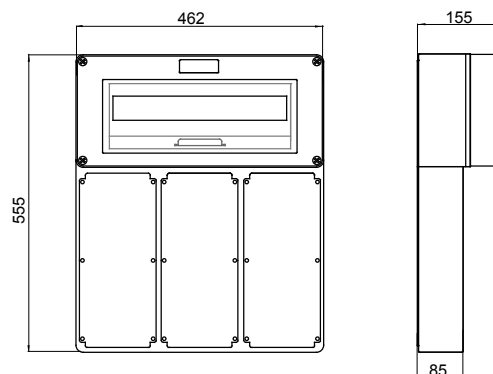

IP waarde	IP66	Vermogens verlies (W)	34
Mechanische weerstand	> IK10	Huishoudelijke vergrend. contactdoos	3
Huishoudelijk IB-wandcontactdozen	16/32 A SELV	Aant. modules EN 50022	18
Zij ingangen	2 x Ø 23	Boven ingangen	5 x Ø 23/29
Onder ingangen	1 x Ø 29/37	Gloeidraadtest	850 °C
Geschikt voor	Zwaar gebruik	Electrocod	2222
Impactweerstand bij +20 °C	20 J		

DIMENSIONAL



TECHNICAL SYMBOLOGY

IP

IP66

IK

> IK10

GWT

850 °C

STANDARDS/APPROVALS

