

Protective Devices



Catalog



Powering Business Worldwide



At Eaton, we believe that power is a fundamental part of just about everything people do. That's why we're dedicated to helping our customers find new ways to manage electrical, hydraulic and mechanical power more efficiently, safely and sustainably. lives, the communities where we live and work, and the planet our future generations depend upon. Because this is what really matters. And we're here to make sure it works.

To learn more go to: [Eaton.com/whatmatters](https://www.eaton.com/whatmatters)

EATON

Powering Business Worldwide

We make what matters work.

SG17011



1.0 Protective Devices - General Information

1.1 Residual Current Devices	5
1.2 Leakage Current Monitor	73
1.3 Arc Fault Detection Devices	76
1.4 Combined RCD/MCB Devices	86
1.5 Miniature Circuit Breakers (MCBs)	207
1.6 Adjustable MCB, Power Limiter	325

SG30811

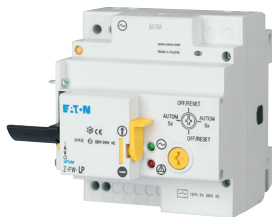

2.0 Accessories for Protective Devices see catalog CA019015EN

- Auxiliary Switch, RCD-Tripping Module, Shunt Trip Release, Undervoltage Release, Remote Control and Automatic Switching Device

SG05013



3.0 Surge Protection see catalog CA010001EN

SG84011



4.0 Controlling & Switching see catalog CA019015EN

- Main Load Disconnect Switch, Installation Contactor, Relay, Signalling Devices, Transformer

SG60112

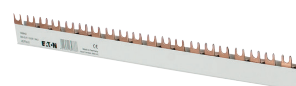

5.0 Busbar Systems see catalog CA019015EN

- Plug-in Busbar System, Busbar block (fork and pin)
- SASY Busbar System

SG80911



6.0 Fuse Devices (Protective Devices) see catalog CA019015EN







sg68912







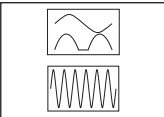

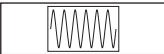
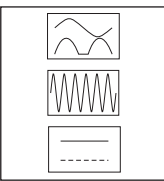
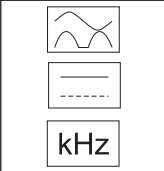
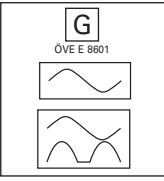
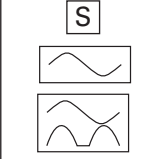

















7.0 Other Accessories see catalog CA019015EN

Residual Current Devices - General Data

Short description of the most important RCD types

Symbol	Description
	Eaton standard. Suitable for outdoor installation (distribution boxes for outdoor installation and building sites) up to -25° C.
	Conditionally surge-current proof (>250 A, 8/20 μs) for general application.
	Type AC: AC current sensitive RCCB
	Type A: AC and pulsating DC current sensitive RCCB, not affected by smooth DC fault currents up to 6 mA
	Type F: AC and pulsating DC current sensitive RCCB, trips also at frequency mixtures (10 Hz, 50 Hz, 1000 Hz), min. 10 ms time-delayed, min. 3 kA surge current proof, higher load capacity with smooth DC fault currents up to 10 mA
	Frequency range up to 20 kHz
	Trips also at frequency mixtures (10 Hz, 50 Hz, 1000 Hz)
	Type B: All-current sensitive RCD switchgear for applications where DC fault currents may occur. Non-selective, non-delayed. Protection against all kinds of fault currents.
	Type B+: All-current sensitive RCD switchgear for applications where DC fault currents may occur. Non-selective, non-delayed. Protection against all kinds of fault currents. Provides enhanced fire safety.
	RCD of type G (min 10 ms time delay) surge current-proof up to 3 kA. For system components where protection against unwanted tripping is needed to avoid personal injury and damage to property. Also for systems involving long lines with high capacitive reactance. Some versions are sensitive to pulsating DC. Some versions are available in all-current sensitive design.
	RCD of type S (selective, min 40 ms time delay) surge current-proof up to 5 kA. Mainly used as main switch, as well as in combination with surge arresters. This is the only RCD suitable for series connection with other types if the rated tripping current of the downstream RCD does not exceed one third of the rated tripping current of the device of type S. Some versions are sensitive to pulsating DC. Some versions are available in all-current sensitive design.

Kind of residual current and correct use of RCD Types

Kind of current	Current profile	Correct use / application field of RCCB types						Tripping current
		AC	A	F	B	/ B+		
Sinusoidal AC residual current								0.5 to 1.0 $I_{\Delta n}$
Pulsating DC residual current (positive or negative half-wave)		-						0.35 to 1.4 $I_{\Delta n}$
Cut half-wave current		-						Lead angle 90°: 0.25 to 1.4 $I_{\Delta n}$ Lead angle 135°: 0.11 to 1.4 $I_{\Delta n}$
Half-wave with smooth DC current of 6 mA		-						max. 1.4 $I_{\Delta n}$ + 6 mA
Half-wave with smooth DC current of 10 mA		-	-					max. 1.4 $I_{\Delta n}$ + 10 mA
Smooth DC current		-	-	-				0.5 to 2.0 $I_{\Delta n}$

Tripping time

Break time and non-actuating time for alternating residual currents (r.m.s. values) for type AC and A RCCB

Classification	$I_{\Delta n}$ mA		$I_{\Delta n}$	$2 \times I_{\Delta n}$	$5 \times I_{\Delta n}$	$5 \times I_{\Delta n}$ or 0.25A	500A
Standard RCD Conditionally surge current-proof 250 A	≤30	Max. tripping time (s)	0.3	0,15		0,04	0.04
Standard RCD Conditionally surge current-proof 250 A	>30	Max. tripping time (s)	0.3	0.15	0.04		0.04
RCCB Type G (Short-time-delay) Surge current-proof 3 kA	30	Min. non actuating time(s) Max. tripping time (s)	0.01 0.3	0.01 0.15		0.01 0.04	0.01 0.04
RCCB Type G (Short-time-delay) Surge current-proof 3 kA	>30	Min. non actuating time(s) Max. tripping time (s)	0.01 0.3	0.01 0.15	0.01 0.04		0.01 0.04
RCCB Type S (Selective) Surge current-proof 5 kA	>30	Min. non actuating time(s) Max. tripping time (s)	0.13 0.5	0.06 0.2	0.05 0.15		0.04 0.15

Break time for half-wave pulsating residual currents (r.m.s. values) for type A RCCB

Classification	$I_{\Delta n}$ mA		$1.4 \times I_{\Delta n}$	$2 \times I_{\Delta n}$	$2.8 \times I_{\Delta n}$	$4 \times I_{\Delta n}$	$7 \times I_{\Delta n}$	0.35 A	0.5 A	350A
Standard RCD Conditionally surge current-proof 250 A	<30	Max. tripping time (s)		0.3		0.15			0.04	0.04
Standard RCD Conditionally surge current-proof 250 A	30	Max. tripping time (s)	0.3		0.15			0.04		0.04
Standard RCD Conditionally surge current-proof 250 A	>30	Max. tripping time (s)	0.3		0.15		0.04			0.04
RCCB Type G (Short-time-delay) Surge current-proof 3 kA	30	Max. tripping time (s)	0.3		0.15			0.04		0.04
RCCB Type G (Short-time-delay) Surge current-proof 3 kA	>30	Max. tripping time (s)	0.3		0.15		0.04			0.04
RCCB Type S (Selective) Surge current-proof 5 kA	>30	Max. tripping time (s)	0.5		0.2		0.15			0.15

Tripping Characteristics (IEC/EN 61008)

Tripping characteristics, tripping time range and selectivity of instantaneous, surge current-proof „G” and surge current-proof - selective „S” residual devices.

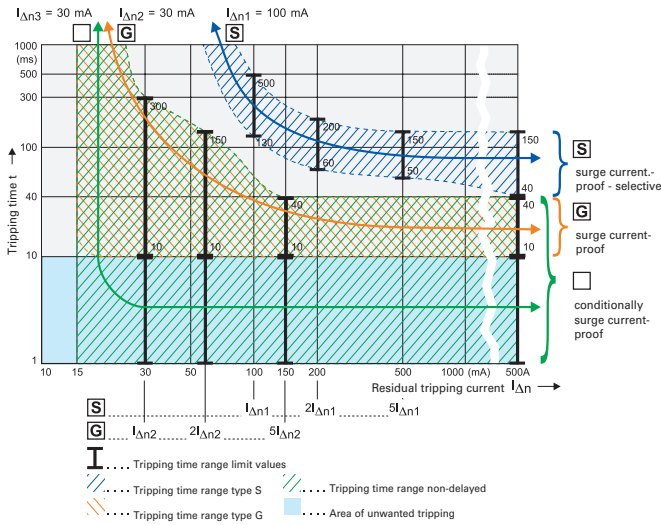

IEC 60364-4-41 deals with additional protection: The use of RCDs with a rated residual operating current not exceeding 30 mA, is recognized in a.c. systems as additional protection in the event of failure of the provision for basic protection and/or the provision for fault protection or carelessness by users.

This means when using RCDs for fault current/residual current protection two RCDs must be connected in series.

Testing:

RCDs with tripping time delay (Types -G and -S) may be function tested with conventional testing equipment which must be set according to the instructions for operation of the testing device. Due to reasons inherent in the measuring process, the tripping time determined in this way may be longer than expected in accordance with the specifications of the manufacturer of the measuring instrument.

However, the device is ok if the result of measurement is within the time range specified by the manufacturer of the measuring instrument.

Due to the currents flowing off through the filters (designated IF), the sum of currents through the RCD is not exactly zero, which causes unwanted tripping.

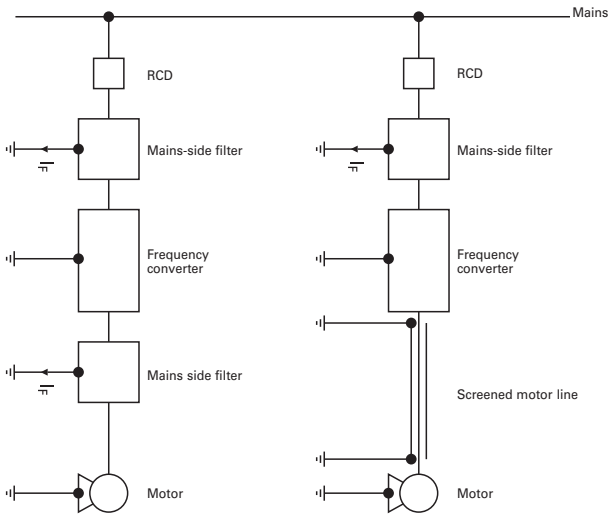

Frequency converters are used in a wide variety of systems and equipment requiring variable speed, such as lifts, escalators, conveyor belts, and large washing machines. Using them for such purposes in circuits with conventional residual current devices causes frequent problems with unwanted tripping.

The technical root cause of this phenomenon is the following: Fast switching operations involving high voltages cause high interference levels which propagate through the lines on the one hand, and in the form of interfering radiation on the other. In order to eliminate this problem, a mains-side filter (also referred to as input filter or EMC-filter) is connected between the RCD and frequency converter. The anti-interference capacitors in the filters produce discharge currents against earth which may cause unwanted tripping of the RCD due to the apparent residual currents. Connecting a filter on the output side between frequency converter and 3-phase AC motor results in the same behaviour.

Tripping characteristic

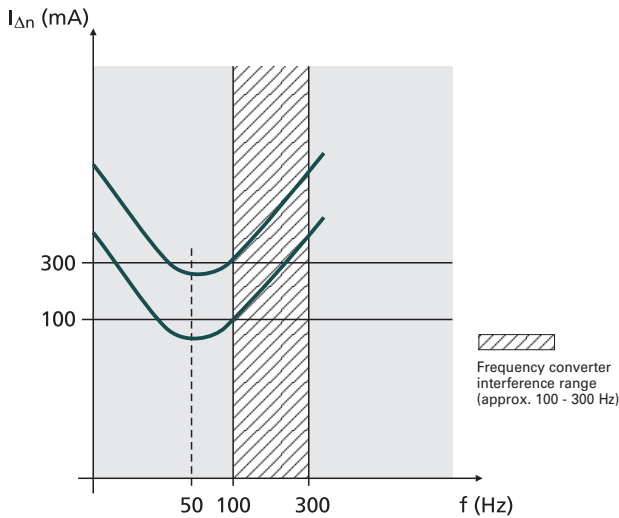

This sample tripping characteristic of a 100 mA RCD and a 300 mA RCD shows the following: In the frequency range around 50 Hz, the RCDs trip as required (50 - 100 % of the indicated $I_{\Delta n}$).

In the range shown hatched in the diagram, i. e. from approx. 100 to 300 Hz, unwanted tripping occurs frequently due to the use of frequency converters. Type F RCCBs are designed to reliably sense higher frequency residual currents, which leads to an enormous increase in the reliability and availability of electrical systems.

Therefore, we recommend to use RCDs designed for applications with frequency converter!

These special residual current devices can be recognised by an extension of the type designation („-F“). They meet the requirements of compatibility between RCDs and frequency converters with respect to unwanted tripping.

Eaton stands for highest availability of your system also in applications where frequency drives are used. Therefore a full suite of Type F RCCBs (mechanical and digital assisted) are available in all feasible ratings to assist you in your application needs.

Our RCDs of type „-F“ are characterized by:

- Improved capabilities of reliably sensing residual currents up to 1 kHz
- Improved capabilities of withstanding 10 mA DC offset
- 10 ms short time delay minimum (G/F)
- Surge current proofness of 3 kA (G/F) and 5 kA (S/F)

SG17011



Description

- A complete spectrum of compact residual current devices for a wide range of applications
- For fault current/residual current protection and additional protection
- Wide variety of nominal currents
- Comprehensive range of accessories
- Real contact position indicator
- Automatic re-setting possible

$I_n/I_{\Delta n}$ (A)	Type Designation	Article No.	Units per package
---------------------------	---------------------	-------------	----------------------

Type AC

Conditionally surge current-proof 250 A, type AC 

SG16611



2-pole

16/0.01	PFIM-16/2/001	235389	1/60
25/0.03	PFIM-25/2/003	235390	1/60
25/0.10	PFIM-25/2/01	235391	1/60
25/0.30	PFIM-25/2/03	235392	1/60
25/0.50	PFIM-25/2/05	235393	1/60
40/0.03	PFIM-40/2/003	235394	1/60
40/0.10	PFIM-40/2/01	235395	1/60
40/0.30	PFIM-40/2/03	235396	1/60
40/0.50	PFIM-40/2/05	235397	1/60
63/0.03	PFIM-63/2/003	235398	1/60
63/0.10	PFIM-63/2/01	235399	1/60
63/0.30	PFIM-63/2/03	235400	1/60
63/0.50	PFIM-63/2/05	235401	1/60
80/0.03	PFIM-80/2/003	235402	1/60
80/0.10	PFIM-80/2/01	235403	1/60
80/0.30	PFIM-80/2/03	235404	1/60
80/0.50	PFIM-80/2/05	235405	1/60
100/0.03	PFIM-100/2/003	102821	1/60
100/0.10	PFIM-100/2/01	102874	1/60
100/0.30	PFIM-100/2/03	102822	1/60

SG17011



4-pole

25/0.03	PFIM-25/4/003	235406	1/30
25/0.10	PFIM-25/4/01	235407	1/30
25/0.30	PFIM-25/4/03	235408	1/30
25/0.50	PFIM-25/4/05	235409	1/30
40/0.03	PFIM-40/4/003	235410	1/30
40/0.10	PFIM-40/4/01	235411	1/30
40/0.30	PFIM-40/4/03	235412	1/30
40/0.50	PFIM-40/4/05	235413	1/30
63/0.03	PFIM-63/4/003	235414	1/30
63/0.10	PFIM-63/4/01	235415	1/30
63/0.30	PFIM-63/4/03	235416	1/30
63/0.50	PFIM-63/4/05	235417	1/30
80/0.03	PFIM-80/4/003	235418	1/30
80/0.10	PFIM-80/4/01	235419	1/30
80/0.30	PFIM-80/4/03	235420	1/30
80/0.50	PFIM-80/4/05	235421	1/30
100/0.03	PFIM-100/4/003	102823	1/30
100/0.10	PFIM-100/4/01	102824	1/30
100/0.30	PFIM-100/4/03	102825	1/30
100/0.50	PFIM-100/4/05	102826	1/30

$I_n/I_{\Delta n}$ (A)	Type Designation	Article No.	Units per package
---------------------------	---------------------	-------------	----------------------

Type A

Conditionally surge current-proof 250 A, sensitive to residual pulsating DC, type A



SG79511



2-pole

16/0.01	PFIM-16/2/001-A	235422	1/60
16/0.03	PFIM-16/2/003-A	235423	1/60
25/0.03	PFIM-25/2/003-A	235424	1/60
25/0.10	PFIM-25/2/01-A	235425	1/60
25/0.30	PFIM-25/2/03-A	235426	1/60
40/0.03	PFIM-40/2/003-A	235427	1/60
40/0.10	PFIM-40/2/01-A	235428	1/60
40/0.30	PFIM-40/2/03-A	235429	1/60
40/0.50	PFIM-40/2/05-A	235430	1/60
63/0.03	PFIM-63/2/003-A	235431	1/60
63/0.10	PFIM-63/2/01-A	235432	1/60
63/0.30	PFIM-63/2/03-A	235433	1/60
63/0.50	PFIM-63/2/05-A	235434	1/60
100/0.10	PFIM-100/2/01-A	102827	1/60
100/0.30	PFIM-100/2/03-A	102828	1/60

SG17011



4-pole

25/0.03	PFIM-25/4/003-A	235435	1/30
25/0.10	PFIM-25/4/01-A	235436	1/30
25/0.30	PFIM-25/4/03-A	235437	1/30
25/0.50	PFIM-25/4/05-A	235438	1/30
40/0.03	PFIM-40/4/003-A	235439	1/30
40/0.10	PFIM-40/4/01-A	235440	1/30
40/0.30	PFIM-40/4/03-A	235441	1/30
40/0.50	PFIM-40/4/05-A	235442	1/30
63/0.03	PFIM-63/4/003-A	235443	1/30
63/0.10	PFIM-63/4/01-A	235444	1/30
63/0.30	PFIM-63/4/03-A	235445	1/30
63/0.50	PFIM-63/4/05-A	235446	1/30
80/0.03	PFIM-80/4/003-A	235447	1/30
80/0.30	PFIM-80/4/03-A	235448	1/30
100/0.03	PFIM-100/4/003-A	102829	1/30
100/0.10	PFIM-100/4/01-A	102870	1/30
100/0.30	PFIM-100/4/03-A	102871	1/30
100/0.50	PFIM-100/4/05-A	102872	1/30

$I_n/I_{\Delta n}$ (A)	Type Designation	Article No.	Units per package
---------------------------	---------------------	-------------	----------------------

Type G

Surge current-proof 3 kA, type G (ÖVE E 8601) 

SG16611



2-pole

25/0.03	PFIM-25/2/003-G	235449	1/60
25/0.10	PFIM-25/2/01-G	235450	1/60
40/0.03	PFIM-40/2/003-G	235451	1/60
40/0.10	PFIM-40/2/01-G	235452	1/60
100/0.10	PFIM-100/2/01-G	110100	1/60

SG17011



4-pole

40/0.03	PFIM-40/4/003-G	235453	1/30
40/0.10	PFIM-40/4/01-G	235455	1/30
63/0.03	PFIM-63/4/003-G	235456	1/30
63/0.10	PFIM-63/4/01-G	235458	1/30
80/0.03	PFIM-80/4/003-G	104385	1/30
100/0.03	PFIM-100/4/003-G	104383	1/30
100/0.3	PFIM-100/4/03-G	104384	1/30

Type G/A

Surge current-proof 3 kA, sensitive to residual pulsating DC, type G/A (ÖVE E 8601) 

SG16611



2-pole

40/0.03	PFIM-40/2/003-G/A	108045	1/60
40/0.10	PFIM-40/2/01-G/A	109429	1/60
63/0.03	PFIM-63/2/003-G/A	108046	1/60
80/0.03	PFIM-80/2/003-G/A	108047	1/60
100/0.03	PFIM-100/2/003-G/A	108048	1/60

SG17011



4-pole

40/0.03	PFIM-40/4/003-G/A	235454	1/30
63/0.03	PFIM-63/4/003-G/A	235457	1/30
63/0.10	PFIM-63/4/01-G/A	109771	1/30
100/0.03	PFIM-100/4/003-G/A	102875	1/30
100/0.30	PFIM-100/4/03-G/A	102873	1/30

$I_n/I_{\Delta n}$ (A)	Type Designation	Article No.	Units per package
---------------------------	---------------------	-------------	----------------------

Type R

Surge current-proof 3 kA, X-ray application, type R

SG17011



4-pole

63/0.03	PFIM-63/4/003-R	235459	1/30
100/0.03	PFIM-100/4/003-R	102876	1/30

Type S

Selective + surge current-proof 5 kA, type S

SG16611



2-pole

40/0.10	PFIM-40/2/01-S	235460	1/60
40/0.30	PFIM-40/2/03-S	235461	1/60

SG17011



4-pole

25/0.30	PFIM-25/4/03-S	235463	1/30
80/0.10	PFIM-80/4/01-S	235473	1/30

Type S/A

Selective + surge current-proof 5 kA, sensitive to residual pulsating DC, type S/A

SG16611



2-pole

40/0.10	PFIM-40/2/01-S/A	109770	1/60
---------	------------------	--------	------

SG17011



4-pole

25/0.10	PFIM-25/4/01-S/A	235464	1/30
40/0.10	PFIM-40/4/01-S/A	235467	1/30
40/0.30	PFIM-40/4/03-S/A	235468	1/30
63/0.10	PFIM-63/4/01-S/A	235471	1/30
63/0.30	PFIM-63/4/03-S/A	235472	1/30
80/0.30	PFIM-80/4/03-S/A	235475	1/30
100/0.30	PFIM-100/4/03-S/A	290220	1/30

Type	Type Designation	Article No.	Units per package
------	------------------	-------------	-------------------

Sealing Cover Set Z-RC/AK

- for PFIM, PFR, PF6, PF7, dRCM

SG82011



2-pole	Z-RC/AK-2TE	285385	10/30
4-pole	Z-RC/AK-4 MU	101062	10/600

SG62111



Description

- Special residual current devices
 - for frequency converter applications
- Für Fehler- and Zusatzschutz
- Comprehensive range of accessories
- Real contact position indicator
- Selective or short-time delayed

$I_n/I_{\Delta n}$ (A)	Type Designation	Article No.	Units per package
---------------------------	---------------------	-------------	----------------------

Type U

Selective + surge current-proof 5 kA, frequency converter-proof, type U 

SG62111



4-pole

40/0.10	PFIM-40/4/01-U	235744	1/30
40/0.30	PFIM-40/4/03-U	235745	1/30
63/0.10	PFIM-63/4/01-U	235746	1/30
63/0.30	PFIM-63/4/03-U	235747	1/30
80/0.30	PFIM-80/4/03-U	290221	1/30
100/0.30	PFIM-100/4/03-U	290222	1/30

Type U

Short-time delayed + surge current-proof 3 kA, frequency converter-proof, type U 

SG62111



4-pole

63/0.03	PFIM-63/4/003-U	285465	1/30
---------	-----------------	--------	------

SG62011



Description

- Special residual current devices
 - back up protection with nominal value possible (overload protection)
- For fault current/residual current protection and additional protection
- Comprehensive range of accessories
- Real contact position indicator
- Automatic re-setting possible
- Special U-types available

$I_n/I_{\Delta n}$ (A)	Type Designation	Article No.	Units per package
---------------------------	---------------------	-------------	----------------------

Type AC, type A

Conditionally surge current-proof 250 A, type AC , type A 

SG16611











2-pole

40/0.03 	PFIM-40/2/003-X	110089	1/60
---	-----------------	--------	------

SG62011



4-pole

40/0.03 	PFIM-40/4/003-X	235737	1/30
40/0.10 	PFIM-40/4/01-X	235738	1/30
63/0.03 	PFIM-63/4/003-X	274293	1/30
63/0.10 	PFIM-63/4/01-X	274296	1/30
40/0.03 	PFIM-40/4/003-XA	235739	1/30
63/0.03 	PFIM-63/4/003-XA	294163	1/30
63/0.10 	PFIM-63/4/01-XA	293304	1/30
63/0.30 	PFIM-63/4/03-XA	293305	1/30





Type G, type G/A

Surge current-proof 3 kA, type G (ÖVE E 8601), type G , type G/A 

SG62011



4-pole

40/0.03 	PFIM-40/4/003-XG	235742	1/30
40/0.10 	PFIM-40/4/01-XG	274292	1/30
63/0.10 	PFIM-63/4/01-XG	293306	1/30
40/0.03 	PFIM-40/4/003-XG/A	235743	1/30
63/0.03 	PFIM-63/4/003-XG/A	103016	1/30





Type S/A

Selective + surge current-proof 5 kA, sensitive to residual pulsating DC, type S/A 

SG62011



4-pole

40/0.10 	PFIM-40/4/01-XS/A	235740	1/30
40/0.30 	PFIM-40/4/03-XS/A	235741	1/30
63/0.10 	PFIM-63/4/01-XS/A	274294	1/30
63/0.30 	PFIM-63/4/03-XS/A	274295	1/30

Type U

Selective + surge current-proof 5 kA, frequency converter-proof, type U 

SG62011



4-pole

40/0.10 	PFIM-40/4/01-XU	235748	1/30
40/0.30 	PFIM-40/4/03-XU	235749	1/30

Specifications | Residual Current Devices PFIM

Description

- Residual Current Devices
- Shape compatible with and suitable for standard busbar connection to other devices of the P-series
- Twin-purpose terminal (lift/open-mouthed) above and below
- Busbar positioning optionally above or below
- Free terminal space despite installed busbar
- Universal tripping signal switch, also suitable for PLS., PKN., Z-A. can be mounted subsequently
- Auxiliary switch Z-HK can be mounted subsequently
- Contact position indicator red - green
- Delayed types suitable for being used with standard fluorescent tubes with or without electronical ballast (30mA-RCD: 30 units per phase conductor, 100mA-RCD: 90 units per phase conductor).
Notes: Depending of the fluorescent lamp ballast manufacturer partly more possible. Symmetrical allocation of the fluorescent lamp ballasts on all phases favourably. Shifting references of the fluorescent lamp ballast manufacturer consider.
- The device functions irrespective of the position of installation
- Tripping is line voltage-independent. Consequently, the RCD is suitable for "fault current/residual current protection" and "additional protection" within the the meaning of the applicable installation rules
- Mains connection at either side
- The 4-pole device can also be used for 2- or 3-pole connection. See connection possibilities.
- The test key "T" must be pressed every 6 month. The system operator must be informed of this obligation and his responsibility in a way that can be proven (self-adhesive RCD-label enclosed). The test intervall of 6 month is valid for residential and similar applications. Under all other conditions (e.g. damply or dusty environments), it's recommended to test in shorter intervalls (e.g. monthly).
- Pressing the test key "T" serves the only purpose of function testing the residual current device (RCD). This test does not make earthing resistance measurement (R_E), or proper checking of the earth conductor condition redundant, which must be performed separately.
- **Type -A:** Protects against special forms of residual pulsating DC which have not been smoothed.
- **Type -G:** High reliability against not affected by smooth DC fault currents up to 6 mA unwanted tripping. Suitable for any circuit where personal injury or damage to property may occur in case of unwanted tripping.
- **Type -G/A:** Additionally protects against special forms of residual pulsating DC which have not been smoothed.
Special types for X-ray application PFIM-...-R.
- **Type -R:** To avoid unwanted tripping due to X-ray devices.
- **Type -S:** Selective residual current device sensitive to AC, type -S
Suitable for systems with surge arresters downstream of the RCD.
- **Type -S/A:** Additionally protects against special forms of residual pulsating DC which have not been smoothed.
- **Type -F:** Suitable for speed-controlled drives with frequency converters in household, trade, and industry.
Unwanted tripping is avoided thanks to a tripping characteristic designed particularly for frequency converters.

Accessories:

Auxiliary switch for subsequent installation to the left	Z-HK	248432
Tripping signal contact for subsequent installation to the right	Z-NHK	248434
Remote control and automatic switching device	Z-FW/LP	248296
Sealing cover set	Z-RC/AK-2TE	285385
	Z-RC/AK-4 MU	101062

Technical Data

		PFIM
Electrical		
Design according to		IEC/EN 61008 Type G according to ÖVE E 8601
Current test marks as printed onto the device		
Tripping		instantaneous
Type G, R		10 ms delay
Type S		40 ms delay - selective disconnecting function
Type U (only 30 mA)		10 ms delay
Type U (without 30 mA)		40 ms delay - selective disconnecting function
Rated voltage	U_n	230/400 V AC, 50 Hz
Rated tripping current	$I_{\Delta n}$	10, 30, 100, 300, 500 mA
Sensitivity		AC and pulsating DC
Rated insulation voltage	U_i	440 V
Rated impulse withstand voltage	U_{imp}	4 kV (1.2/50 μ s)
Rated short-circuit strength	I_{cn}	10 kA

Maximum back-up fuse PFIM

Rating	Fuses		MCB's (Characteristic B/C)	
I_n [A]	Short-circuit [A]	Overload [A]	Short-circuit [A]	Overload [A]
16	63 gG/gI	10 gG/gI	–	–
25	63 gG/gI	16 gG/gI	C20	C20
40	63 gG/gI	25 gG/gI	C25	C25
63	63 gG/gI	40 gG/gI	C40	C40
80	80 gG/gI	50 gG/gI	–	–
100	100 gG/gI	63 gG/gI	–	–
Type PFIM-X:				
40	63 gG/gI	40 gG/gI	C25	C25
63	63 gG/gI	63 gG/gI	C40	C40

Important: In the case that the maximal possible operating current of the electrical installation don't exceed the rated current of the RCD only short-circuit protection must be implemented. Overload protection must be implemented in the case if the maximal possible operating current of the electrical installation can exceed the rated current of the RCD.

Rated breaking capacity	I_m	
Rated fault breaking capacity	$I_{\Delta m}$	
$I_n = 16-40$ A		500 A
$I_n = 63$ A		630 A
$I_n = 80$ A		800 A
$I_n = 100$ A		1000 A

Voltage range of test button	
2-pole	196 - 264 V~
4-pole 30 mA	196 - 264 V~
4-pole 10, 100, 300, 500 mA	196 - 456 V~

Endurance	
electrical components	$\geq 4,000$ switching operations
mechanical components	$\geq 20,000$ switching operations

Mechanical

Frame size	45 mm
Device height	80 mm
Device width	35 mm (2 MU), 70 mm (4 MU)
Mounting	quick fastening with 2 lock-in positions on DIN rail IEC/EN 60715
Degree of protection, built-in	IP40
Degree of protection in moisture-proof enclosure	IP54
Upper and lower terminals	open-mouthed/lift terminals
Terminal protection	finger and hand touch safe, DGUV VS3, EN 50274
Terminal capacity	1.5 - 35 mm ² single wire 2 x 16 mm ² multi wire
Terminal screw	M5 (mit geschlitzter Schraube according to EN ISO 4757-Z2, Pozidriv PZ2)
Terminal torque	2 - 2.4 Nm
Busbar thickness	0.8 - 2 mm
Operating temperature	-25°C to +40°C
Storage- and transport temperature	-35°C to +60°C
Resistance to climatic conditions	25-55°C/90-95% relative humidity according to IEC 60068-2

Connection diagrams

2-pole

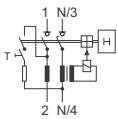

4-pole

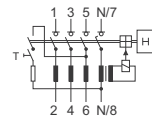

Dimensions (mm)

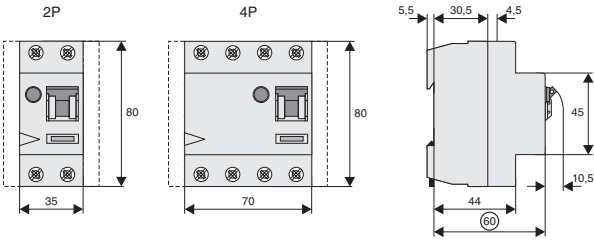

Correct connection

2-pole

30, 100, 300, 500 mA types:

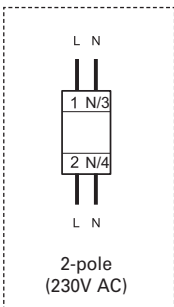

4-pole

30 mA types:

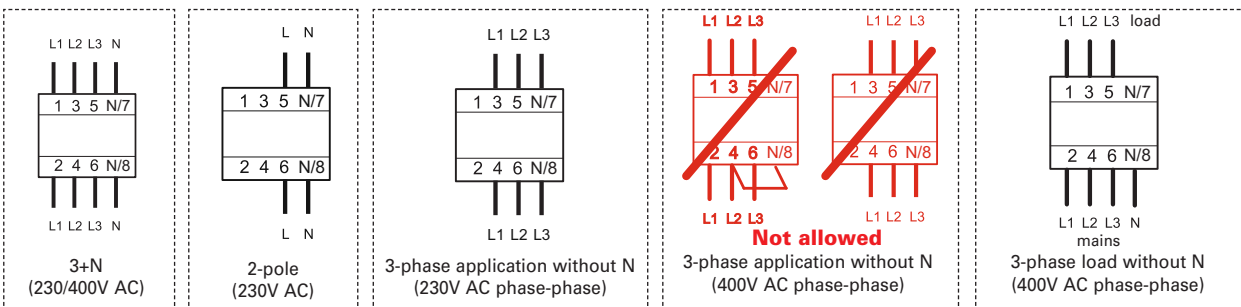

10, 100, 300, 500 mA types:

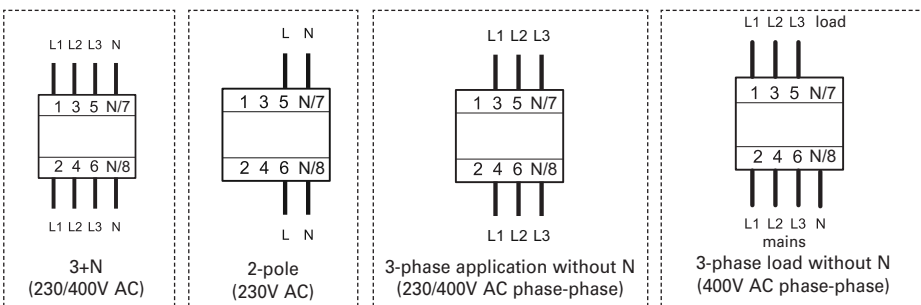

Influence of the ambient temperature to the maximum continuous current (A)

Ambient temperature	16A		25A		40A		63A		80A		100A	
	2p	4p	2p	4p	2p	4p	2p	4p	2p	4p	2p	4p
40°	16	16	25	25	40	40	63	63	80	80	100	100
45°	14	14	21	22	37	37	59	59	76	76	95	95
50°	11	11	18	19	33	34	55	55	72	72	90	90
55°	9	9	14	16	30	31	50	50	68	68	85	85
60°	– *)	–	–	–	26	27	45	45	64	64	80	80

Annotation: It has to be ensured that the values in the table are not exceeded and the back-up fuse/thermal protection works properly.

*) not applicable

wa_sg02716



Description

- Increased protection in applications with 1-phase frequency converter due to the detection of mixed frequencies
- Reduction of nuisance tripping thanks to
 - time delayed tripping
 - increased current withstand capability > 3 kA
- Higher load rating with DC residual currents up to 10 mA
- For fault current/residual current protection and additional protection
- Comprehensive range of accessories
- Real contact position indicator
- Automatic re-setting possible

$I_n/I_{\Delta n}$ (A)	Type Designation	Article No.	Units per package
---------------------------	---------------------	-------------	----------------------

Type G/F

Surge current-proof 3 kA, sensitive to residual pulsating DC, type G/F (ÖVE E 8601)  

wa_sg02816



2-pole

25/0.03	PFIM-25/2/003-G/F	187449	1/60
25/0.30	PFIM-25/2/03-G/F	187452	1/60
40/0.03	PFIM-40/2/003-G/F	187450	1/60
40/0.30	PFIM-40/2/03-G/F	187453	1/60
63/0.03	PFIM-63/2/003-G/F	187451	1/60
63/0.30	PFIM-63/2/03-G/F	187454	1/60

wa_sg02716



4-pole

25/0.03	PFIM-25/4/003-G/F	187455	1/30
25/0.30	PFIM-25/4/03-G/F	187359	1/30
40/0.03	PFIM-40/4/003-G/F	187456	1/30
40/0.30	PFIM-40/4/03-G/F	187360	1/30
63/0.03	PFIM-63/4/003-G/F	187358	1/30
63/0.30	PFIM-63/4/03-G/F	187361	1/30

Type S/F

Selective + surge current-proof 5 kA, sensitive to residual pulsating DC, type S/F  

wa_sg02716



4-pole

25/0.30	PFIM-25/4/03-S/F	187362	1/30
40/0.30	PFIM-40/4/03-S/F	187363	1/30
63/0.30	PFIM-63/4/03-S/F	187364	1/30

Specifications | Residual Current Devices PFIM-F

Description

- Residual Current Devices
- Shape compatible with and suitable for standard busbar connection to other devices of the P-series
- Twin-purpose terminal (lift/open-mouthed) above and below
- Busbar positioning optionally above or below
- Free terminal space despite installed busbar
- Universal tripping signal switch, also suitable for PLS., PKN., Z-A. can be mounted subsequently
- Auxiliary switch Z-HK can be mounted subsequently
- Contact position indicator red - green
- Delayed types suitable for being used with standard fluorescent tubes with or without electronical ballast (30mA-RCD: 30 units per phase conductor).
Notes: Depending of the fluorescent lamp ballast manufacturer partly more possible. Symmetrical allocation of the fluorescent lamp ballasts on all phases favourably. Shifting references of the fluorescent lamp ballast manufacturer consider.
- The device functions irrespective of the position of installation
- Tripping is line voltage-independent. Consequently, the RCD is suitable for "fault current/residual current protection" and "additional protection" within the the meaning of the applicable installation rules
- Mains connection at either side
- The 4-pole device can also be used for 2- or 3-pole connection. See connection possibilities.
- The test key "T" must be pressed every 6 month. The system operator must be informed of this obligation and his responsibility in a way that can be proven (self-adhesive RCD-label enclosed). The test intervall of 6 month is valid for residential and similar applications. Under all other conditions (e.g. damply or dusty environments), it's recommended to test in shorter intervalls (e.g. monthly).
- Pressing the test key "T" serves the only purpose of function testing the residual current device (RCD). This test does not make earthing resistance measurement (R_E), or proper checking of the earth conductor condition redundant, which must be performed separately.
- **Type -F:** Increased protection in applications with 1-phase frequency converter due to the detection of mixed frequencies, higher load capacity with smooth DC fault currents up to 10 mA.

Accessories:

Auxiliary switch for subsequent installation to the left	Z-HK	248432
Tripping signal contact for subsequent installation to the right	Z-NHK	248434
Remote control and automatic switching device	Z-FW/LP	248296
Sealing cover set	Z-RC/AK-2TE	285385
	Z-RC/AK-4 MU	101062

Technical Data

		PFIM-F
Electrical		
Design according to		IEC/EN 62423 Type G according to ÖVE E 8601
Current test marks as printed onto the device		
Tripping		instantaneous
Type G		10 ms delay
Type S		40 ms delay - selective disconnecting function
Rated voltage	U_n	230/400 V AC, 50 Hz
Rated tripping current	$I_{\Delta n}$	30, 300 mA
Sensitivity		AC and pulsating DC
Rated insulation voltage	U_i	440 V
Rated impulse withstand voltage	U_{imp}	4 kV (1.2/50 μ s)
Rated short-circuit strength	I_{cn}	10 kA
Maximum back-up fuse PFIM-F		
	Rating	Fuses
	I_n [A]	Short-circuit [A] Overload [A]
	25	63 gG/gI 16 gG/gI
	40	63 gG/gI 25 gG/gI
	63	63 gG/gI 40 gG/gI
		MCB's (Characteristic B/C)
		Short-circuit [A] Overload [A]
		C20 C20
		C25 C25
		C40 C40
Important: In the case that the maximal possible operating current of the electrical installation don't exceed the rated current of the RCD only short-circuit protection must be implemented. Overload protection must be implemented in the case if the maximal possible operating current of the electrical installation can exceed the rated current of the RCD.		
Rated breaking capacity	I_m	
Rated fault breaking capacity	$I_{\Delta m}$	
$I_n = 16-40$ A		500 A
$I_n = 63$ A		630 A
Voltage range of test button		
2-pole		196 - 264 V~
4-pole 30 mA		196 - 264 V~
4-pole 300 mA		196 - 456 V~
Endurance		
electrical components		$\geq 4,000$ switching operations
mechanical components		$\geq 20,000$ switching operations
Mechanical		
Frame size		45 mm
Device height		80 mm
Device width		35 mm (2 MU), 70 mm (4 MU)
Mounting		quick fastening with 2 lock-in positions on DIN rail IEC/EN 60715
Degree of protection, built-in		IP40
Degree of protection in moisture-proof enclosure		IP54
Upper and lower terminals		open-mouthed/lift terminals
Terminal protection		finger and hand touch safe, DGUV VS3, EN 50274
Terminal capacity		1.5 - 35 mm ² single wire 2 x 16 mm ² multi wire
Terminal screw		M5 (mit geschlitzter Schraube according to EN ISO 4757-Z2, Pozidriv PZ2)
Terminal torque		2 - 2.4 Nm
Busbar thickness		0.8 - 2 mm
Operating temperature		-25°C to +40°C
Storage- and transport temperature		-35°C to +60°C
Resistance to climatic conditions		25-55°C/90-95% relative humidity according to IEC 60068-2

Connection diagrams

2-pole

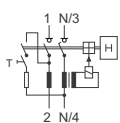

4-pole

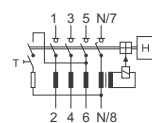

Dimensions (mm)

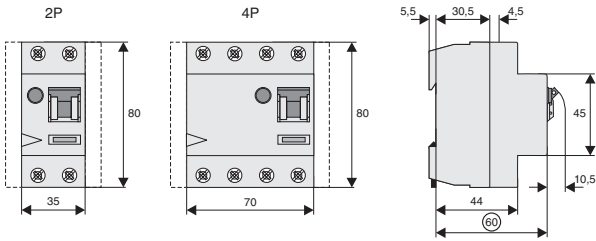

Correct connection

2-pole

30, 300 mA types:

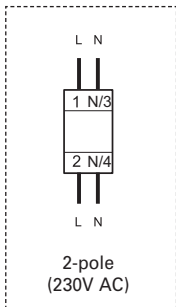

4-pole

30 mA types:

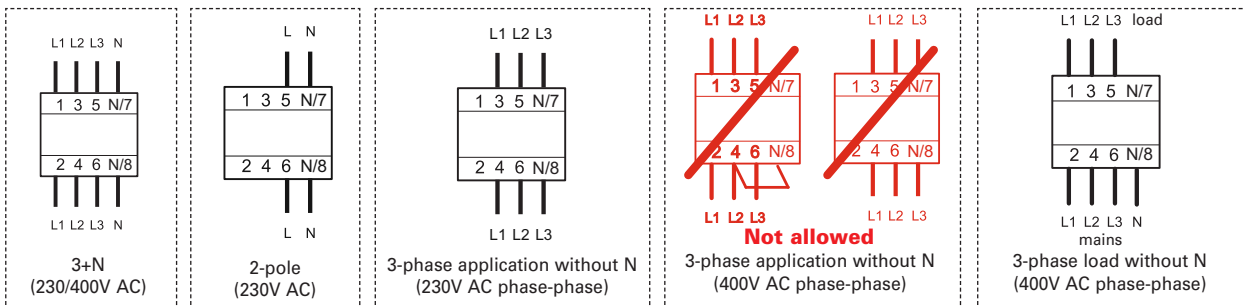

300 mA types:

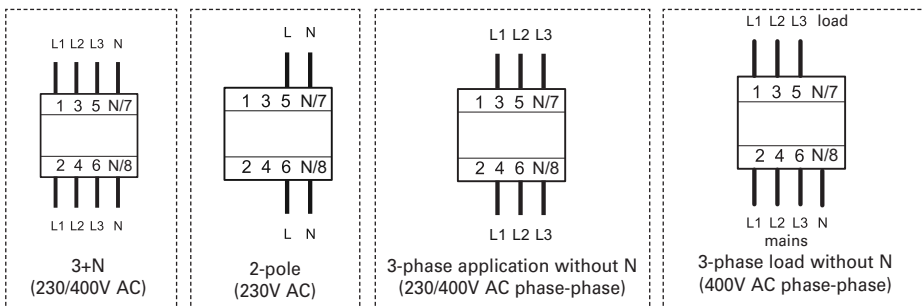

wa_ren_02619



Description

- All-current sensitive RCCB for fault or additional protection
- 4-pole types can also be used as 2-pole devices for photovoltaic / EV charging applications
- New level of accuracy -> reduced unwanted tripping
 - time delay tripping
 - increased current withstand capability
 - > 3 kA
 - handles all DC currents
 - handles mixed frequencies up to 1kHz (Bfq up to 50 kHz)
- Back up protection with nominal value possible (overload protection)
- Yearly test interval
- Real contact position indicator
- Automatic re-setting possible
- Transparent designation plate

$I_n/I_{\Delta n}$
(A)

Type
Designation

Article No. Units per
package

Type G/B

Surge current-proof 3 kA, AC-DC sensitive, Type G/B (ÖVE E 8601)



wa_ren_04320



2-pole (4 MU)

25/0.03	PFIM-25/2/003-XG/B	301751	1/30
40/0.03	PFIM-40/2/003-XG/B	301752	1/30
63/0.03	PFIM-63/2/003-XG/B	301803	1/30

wa_ren_02619



4-pole

40/0.03	PFIM-40/4/003-XG/B	300305	1/30
63/0.03	PFIM-63/4/003-XG/B	300306	1/30

Type S/B

Selective + surge current-proof 5 kA, Type S/B



wa_ren_04520



2-pole (4 MU)

25/0.30	PFIM-25/2/03-XS/B	301804	1/30
40/0.30	PFIM-40/2/03-XS/B	301809	1/30
63/0.30	PFIM-63/2/03-XS/B	301813	1/30

wa_ren_02719



4-pole

40/0.30	PFIM-40/4/03-XS/B	300307	1/30
63/0.30	PFIM-63/4/03-XS/B	300308	1/30

$I_n/I_{\Delta n}$
(A)

Type
Designation

Article No. Units per
package

Type G/Bfq

Surge current-proof 3 kA, AC-DC sensitive, Type G/Bfq (ÖVE E 8601)



wa_ren_02619



4-pole

40/0.03	PFIM-40/4/003-XG/Bfq	300984	1/30
63/0.03	PFIM-63/4/003-XG/Bfq	300985	1/30

Type S/Bfq

Selective + surge current-proof 5 kA, Type S/Bfq



wa_ren_02719



4-pole

40/0.30	PFIM-40/4/03-XS/Bfq	300987	1/30
63/0.30	PFIM-63/4/03-XS/Bfq	300988	1/30

Specifications | Residual Current Devices PFIM-B, Bfq

Description

- Residual Current Devices
- Shape compatible with and suitable for standard busbar connection to other devices of the P-series
- Twin-purpose terminal (lift/open-mouthed) above and below
- Busbar positioning optionally above or below
- Free terminal space despite installed busbar
- Universal tripping signal switch, also suitable for PLS., PKN., Z-A. can be mounted subsequently
- Auxiliary switch Z-HK can be mounted subsequently
- Contact position indicator red - green
- Delayed types suitable for being used with standard fluorescent tubes with or without electronical ballast (30mA-RCD: 30 units per phase conductor)
Notes: Depending of the fluorescent lamp ballast manufacturer partly more possible. Symmetrical allocation of the fluorescent lamp ballasts on all phases favourably. Shifting references of the fluorescent lamp ballast manufacturer consider.
- The device functions irrespective of the position of installation
- The RCD is suitable for "fault protection" and "additional protection" within the meaning of the applicable installation rules.
- The 4-pole device can also be used for 2- or 3-pole connection. See connection possibilities.
- The test key "T" must be pressed every year. The system operator must be informed of this obligation and his responsibility in a way that can be proven. Under special conditions (e.g. damply and/or dusty environments, environments with polluting and/or corroding conditions, environments with large temperature fluctuations, installations with a risk of overvoltages due to switching of equipment and/or atmospheric discharges, portable equipment ...), it's recommended to test in monthly intervals.
- Pressing the test key "T" serves the only purpose of function testing the residual current device (RCD). This test does not make earthing resistance measurement (R_E), or proper checking of the earth conductor condition redundant, which must be performed separately.
- **Type -G/B:** High reliability against unwanted tripping. Suitable for any circuit where personal injury or damage to property may occur in case of unwanted tripping. Protection against all types of fault currents.
- **Type -S/B:** Selective residual current device. Protection against all types of fault currents.
- **Type -G/Bfq and S/Bfq:** Suitable for speed-controlled drives with frequency converters inhousehold, trade, and industry. Unwanted tripping is avoided thanks to a tripping characteristic designed particularly for frequency converters. Protection against all types of fault currents.

Accessories:

Auxiliary switch for subsequent installation to the left	Z-HK	248432
Tripping signal contact for subsequent installation to the right	Z-NHK	248434
Remote control and automatic switching device	Z-FW/LP	248296
Sealing cover set	Z-RC/AK-2TE	285385
	Z-RC/AK-4 MU	101062

Technical Data

		PFIM-B, Bfq	
Electrical			
Design according to		acc. to IEC/EN 61008, IEC/EN 62423, Type G/B and G/Bfq - additional acc. to ÖVE E 8601.	
Current test marks as printed onto the device			
Tripping			
Type G		10 ms delay @ 50 Hz	
Type S		40 ms delay @ 50 Hz - with selective disconnecting function	
Rated voltage		U_n	230/400 V AC, 50 Hz
Limits operation voltage electronic		50 – 456V AC	
Limits operation voltage test circuit			
30 mA		196 - 253V AC	
300 mA		196 - 440V AC	
Rated tripping current		$I_{\Delta n}$	30, 300 mA
Sensitivity		All types of current	
Rated insulation voltage		U_i	440 V
Rated impulse withstand voltage		U_{imp}	4 kV (1.2/50 μ s)
Rated short-circuit capacity		I_{cn}	10 kA with back-up fuse
Maximum back-up fuse PFIM-B			
Rating	Fuses	MCB's (Characteristic B/C)	
I_n [A]	Short-circuit [A]	Overload [A]	Short-circuit [A]
25	63 gG/gl	25 gG/gl	FAZ-C40
40	63 gG/gl	40 gG/gl	FAZ-C40
63	63 gG/gl	63 gG/gl	FAZ-C40
Overload [A]		Overload [A]	
		FAZ-C25	
		FAZ-C40	
		FAZ-C40	
Important: In the case that the maximal possible operating current of the electrical installation don't exceed the rated current of the RCD only short-circuit protection must be implemented. Overload protection must be implemented in the case if the maximal possible operating current of the electrical installation can exceed the rated current of the RCD.			
Peak withstand current			
Type G/B, G/Bfq		3 kA (8/20 μ s) surge current-proof	
Type S/B, S/Bfq		5 kA (8/20 μ s) selective + surge current-proof	
Rated breaking capacity		I_m	
Rated fault breaking capacity		$I_{\Delta m}$	
$I_n = 25-40$ A		500 A	
$I_n = 63$ A		630 A	
Endurance			
electrical components		$\geq 4,000$ switching operations	
mechanical components		$\geq 20,000$ switching operations	
Mechanical			
Frame size		45 mm	
Device height		80 mm	
Device width		70 mm (4 MU)	
Mounting		quick fastening with 2 lock-in positions on DIN rail IEC/EN 60715	
Degree of protection, built-in		IP40	
Degree of protection in moisture-proof enclosure		IP54	
Upper and lower terminals		open-mouthed/lift terminals	
Terminal protection		finger and hand touch safe, DGUV VS3, EN 50274	
Terminal capacity		1.5 - 35 mm ² single wire	
		2 x 16 mm ² multi wire	
Terminal screw		M5 (with slotted screw acc. to EN ISO 4757-Z2, Pozidriv PZ2)	
Terminal torque		2 - 2.4 Nm	
Busbar thickness		0.8 - 2 mm	
Operation temperature		-25°C to +40°C (for higher values see table on ambient temperature)	
Storage- and transport temperature		-35°C to +60°C	
Resistance to climatic conditions		25-55°C/90-95% relative humidity according to IEC 60068-2	
Contact position indicator		red / green	

Power Loss at I_n PFIM-B, Bfq

(entire unit)			
I_n [A]	P^* [W]	2p	4p
25	3.1	4.6	
40	4.1	6.2	
63	6.7	10	

* 50Hz

Influence of the ambient temperature to the maximum continuous current (A)

Ambient temperature	25A	40A	63A
	2 & 4p	2 & 4p	2 & 4p
40°	25	40	63
45°	21	37	56
50°	18	34	50

Connection diagram

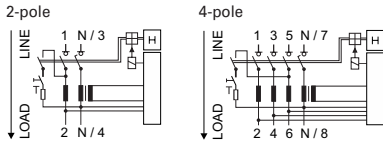

Dimensions (mm)

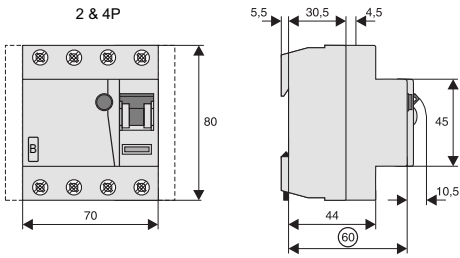

Correct connection

30 mA types:

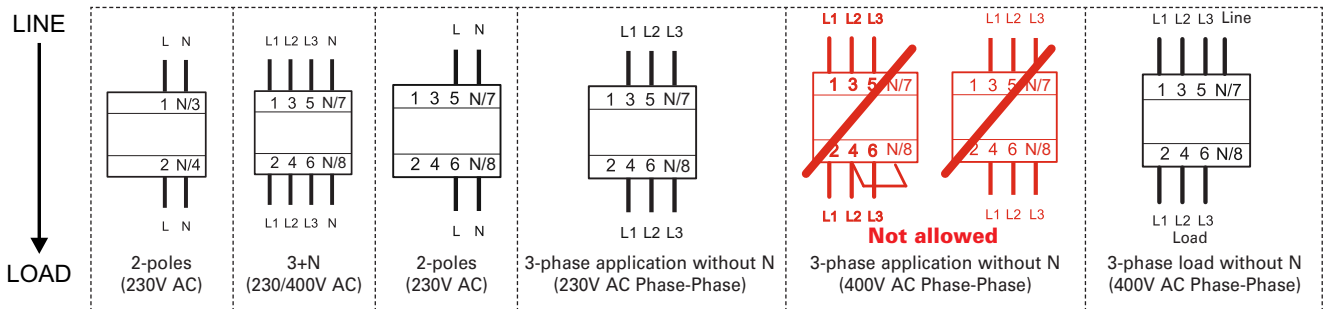

300 mA types:

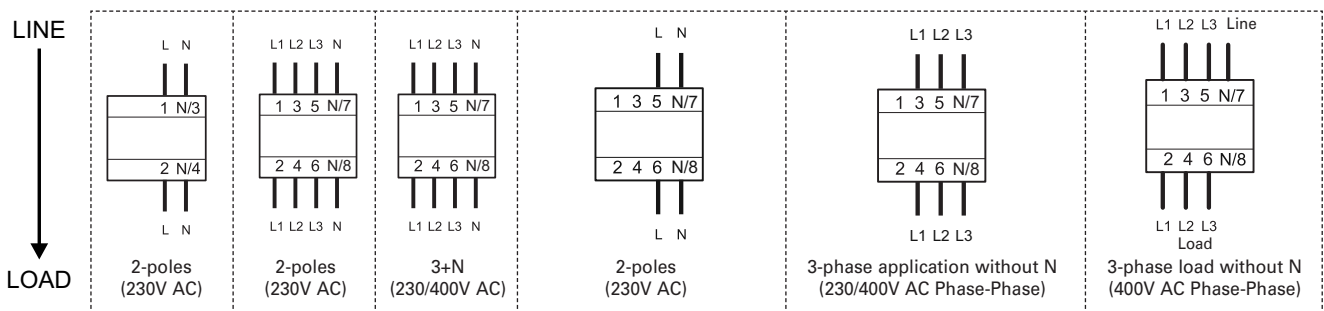

- Disconnect load side of the switch gear, if you make a insulation test of the installation!
- Please take care of supply side and load side!

Tripping current frequency response PFIM-B, Bfq

Type B 30mA

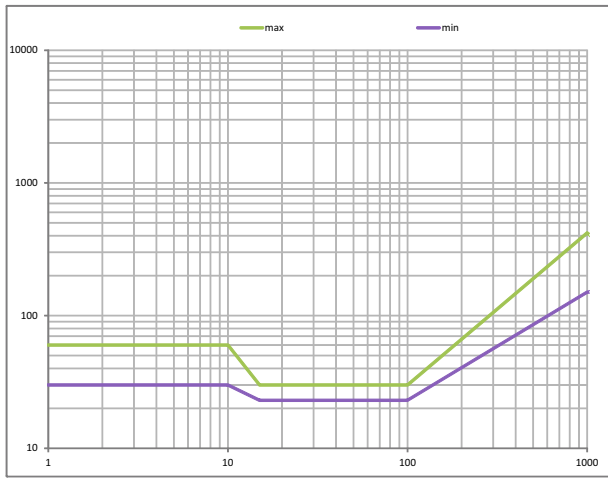

Type B 300mA

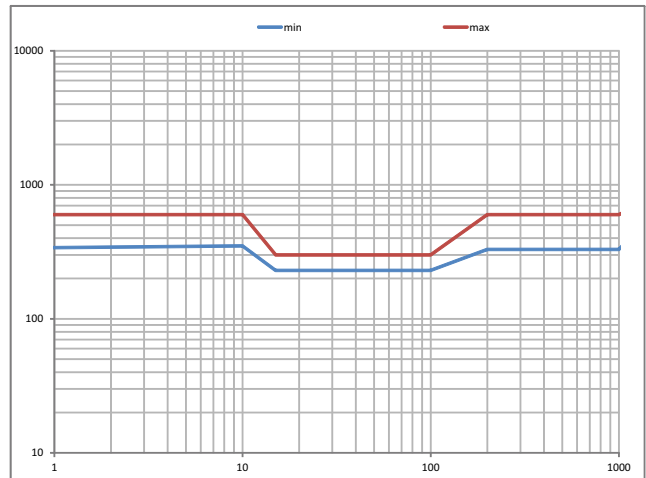

Type Bfq 30mA

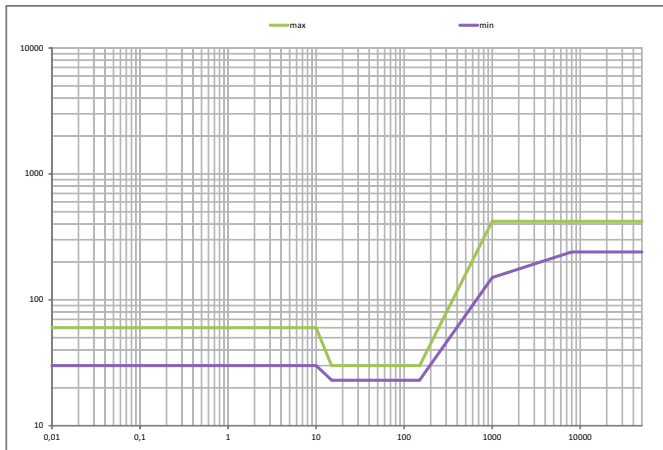

Type Bfq 300mA

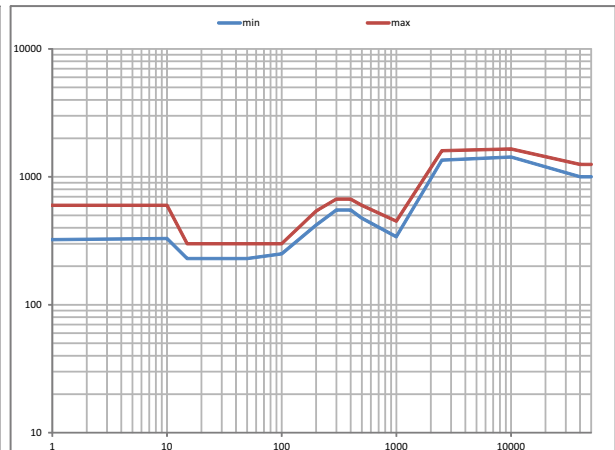

SG08211



Description

- A complete spectrum of compact residual current devices for a wide range of applications to 100 A
- Rated short-circuit strength 10 kA
- Especially for protection against accidents caused by current and property protection
- Wide variety of types (G, S, A, G/A, S/A, R, U, ...)
- Special type U for frequency converter applications with high surge current proof
- Comprehensive range of accessories can be mounted subsequently
- Frost resistance 

$I_n/I_{\Delta n}$ (A)	Type Designation	Article No.	Units per package
---------------------------	---------------------	-------------	----------------------

Type AC

Conditionally surge current-proof 250 A, type AC 

SG07411



2-pole

25/0.03	PF7-25/2/003	263577	1/60
25/0.10	PF7-25/2/01	263578	1/60
40/0.03	PF7-40/2/003	263579	1/60
40/0.10	PF7-40/2/01	263580	1/60
63/0.03	PF7-63/2/003	263581	1/60
63/0.10	PF7-63/2/01	263582	1/60
63/0.30	PF7-63/2/03	263583	1/60
100/0.03	PF7-100/2/003	166797	1/60
100/0.10	PF7-100/2/01	166799	1/60
100/0.30	PF7-100/2/03	166822	1/60

SG08211



4-pole

25/0.03	PF7-25/4/003	263584	1/30
25/0.10	PF7-25/4/01	263585	1/30
40/0.03	PF7-40/4/003	263586	1/30
40/0.10	PF7-40/4/01	263587	1/30
40/0.30	PF7-40/4/03	263588	1/30
40/0.50	PF7-40/4/05	263589	1/30
63/0.03	PF7-63/4/003	263590	1/30
63/0.10	PF7-63/4/01	263591	1/30
63/0.30	PF7-63/4/03	263592	1/30
63/0.50	PF7-63/4/05	263593	1/30
80/0.03	PF7-80/4/003	263594	1/30
80/0.10	PF7-80/4/01	263595	1/30
80/0.30	PF7-80/4/03	263596	1/30
80/0.50	PF7-80/4/05	263597	1/30
100/0.03	PF7-100/4/003	102925	1/30
100/0.10	PF7-100/4/01	102926	1/30
100/0.30	PF7-100/4/03	102927	1/30
100/0.50	PF7-100/4/05	102928	1/30

$I_n/I_{\Delta n}$ (A)	Type Designation	Article No.	Units per package
---------------------------	---------------------	-------------	----------------------

Type A

Conditionally surge current-proof 250 A, sensitive to residual pulsating DC, type A 

SG07411



2-pole

16/0.01	PF7-16/2/001-A	263598	1/60
25/0.03	PF7-25/2/003-A	263599	1/60
25/0.10	PF7-25/2/01-A	263600	1/60
25/0.30	PF7-25/2/03-A	263601	1/60
40/0.03	PF7-40/2/003-A	263602	1/60
40/0.10	PF7-40/2/01-A	263603	1/60
40/0.30	PF7-40/2/03-A	263604	1/60
63/0.03	PF7-63/2/003-A	263605	1/60
63/0.10	PF7-63/2/01-A	263606	1/60
63/0.30	PF7-63/2/03-A	263607	1/60
100/0.10	PF7-100/2/01-A	166820	1/60
100/0.30	PF7-100/2/03-A	166823	1/60

SG08211



4-pole

25/0.03	PF7-25/4/003-A	263608	1/30
25/0.10	PF7-25/4/01-A	263609	1/30
25/0.30	PF7-25/4/03-A	263610	1/30
40/0.03	PF7-40/4/003-A	263611	1/30
40/0.10	PF7-40/4/01-A	263612	1/30
40/0.30	PF7-40/4/03-A	263613	1/30
63/0.03	PF7-63/4/003-A	263614	1/30
63/0.10	PF7-63/4/01-A	263615	1/30
63/0.30	PF7-63/4/03-A	263616	1/30
80/0.03	PF7-80/4/003-A	263617	1/30
80/0.30	PF7-80/4/03-A	263618	1/30
100/0.03	PF7-100/4/003-A	102929	1/30
100/0.10	PF7-100/4/01-A	102930	1/30
100/0.30	PF7-100/4/03-A	102931	1/30
100/0.50	PF7-100/4/05-A	102932	1/30

$I_n/I_{\Delta n}$
(A)

Type
Designation

Article No. Units per
package









Type G, type G/A

Surge current-proof 3 kA, type G (ÖVE E 8601), type G  , type G/A 

SG07411









2-pole

25/0.03		PF7-25/2/003-G	263619	1/60
25/0.10		PF7-25/2/01-G	263620	1/60
40/0.03		PF7-40/2/003-G	263621	1/60
40/0.10		PF7-40/2/01-G	263622	1/60
40/0.03		PF7-40/2/003-G/A	166826	1/60
63/0.03		PF7-63/2/003-G/A	166827	1/60
80/0.03		PF7-80/2/003-G/A	166828	1/60
100/0.03		PF7-100/2/003-G/A	166798	1/60

SG08211



4-pole

40/0.03		PF7-40/4/003-G	263623	1/30
40/0.10		PF7-40/4/01-G	263624	1/30
63/0.03		PF7-63/4/003-G	263625	1/30
63/0.10		PF7-63/4/01-G	263627	1/30
80/0.03		PF7-80/4/003-G/A	166824	1/30
100/0.03		PF7-100/4/003-G/A	166829	1/30
100/0.3		PF7-100/4/03-G/A	166825	1/30

Type R

Surge current-proof 3 kA, X-ray application, type R 

SG08211



4-pole

63/0.03		PF7-63/4/003-R	263628	1/30
100/0.03		PF7-100/4/003-R	102935	1/30

Type S

Selective + surge current-proof 5 kA, type S 

SG07411



2-pole

40/0.10		PF7-40/2/01-S	263629	1/60
40/0.30		PF7-40/2/03-S	263630	1/60

SG08211



4-pole

80/0.10		PF7-80/4/01-S	263636	1/30
---------	--	---------------	--------	------

$I_n/I_{\Delta n}$ (A)	Type Designation	Article No.	Units per package
---------------------------	---------------------	-------------	----------------------

Type S/A

Selective + surge current-proof 5 kA, sensitive to residual pulsating DC, type S/A 

SG08211



4-pole

25/0.10	PF7-25/4/01-S/A	263631	1/30
40/0.10	PF7-40/4/01-S/A	263632	1/30
40/0.30	PF7-40/4/03-S/A	263633	1/30
63/0.10	PF7-63/4/01-S/A	263634	1/30
63/0.30	PF7-63/4/03-S/A	263635	1/30
80/0.30	PF7-80/4/03-S/A	263637	1/30
100/0.30	PF7-100/4/03-S/A	292494	1/30

SG08211



Description

- Special residual current devices
 - for frequency converter applications
- For fault current/residual current protection and additional protection
- Comprehensive range of accessories can be mounted subsequently
- Real contact position indicator
- Selective
- Frost resistance 

Residual Current Devices PF7-U

$I_n/I_{\Delta n}$ (A)	Type Designation	Article No.	Units per package
---------------------------	---------------------	-------------	----------------------

Type U

Selective + surge current-proof 5 kA, frequency converter-proof, type U

SG08211



4-pole

40/0.10	PF7-40/4/01-U	263638	1/30
40/0.30	PF7-40/4/03-U	263639	1/30
63/0.10	PF7-63/4/01-U	263640	1/30
63/0.30	PF7-63/4/03-U	263641	1/30
80/0.30	PF7-80/4/03-U	292495	1/30
100/0.30	PF7-100/4/03-U	292496	1/30

Type	Type Designation	Article No.	Units per package
------	---------------------	-------------	----------------------

Sealing Cover Set Z-RC/AK

- for PFIM, PFR, PF6, PF7, dRCM

SG82011



2-pole	Z-RC/AK-2TE	285385	10/30
4-pole	Z-RC/AK-4 MU	101062	10/600

Specifications | Residual Current Devices PF7

Description

- Residual Current Devices
- Shape compatible with and suitable for standard busbar connection to other devices of the P-series
- Twin-purpose terminal (lift/open-mouthed) above and below
- Busbar positioning optionally above or below
- Free terminal space despite installed busbar
- Universal tripping signal switch, also suitable for PL-, PFL-, Z-A. can be mounted subsequently
- Auxiliary switch Z-HK can be mounted subsequently
- Contact position indicator red - green
- Delayed types suitable for being used with standard fluorescent tubes with or without electronical ballast (30mA-RCD: 30 units per phase conductor, 100mA-RCD: 90 units per phase conductor).
Notes: Depending of the fluorescent lamp ballast manufacturer partly more possible. Symmetrical allocation of the fluorescent lamp ballasts on all phases favourably. Shifting references of the fluorescent lamp ballast manufacturer consider.
- The device functions irrespective of the position of installation
- Tripping is line voltage-independent. Consequently, the RCD is suitable for "fault current/residual current protection" and "additional protection" within the the meaning of the applicable installation rules
- Mains connection at either side
- Types with 80 and 100 A permissible short-circuit back-up fuse (PF7-80, PF7-100): Take into account overload protection
- The 4-pole device can also be used for 2- or 3-pole connection. See connection possibilities.
- The test key "T" must be pressed every 6 month. The system operator must be informed of this obligation and his responsibility in a way that can be proven (self-adhesive RCD-label enclosed). The test intervall of 6 month is valid for residential and similar applications. Under all other conditions (e.g. damply or dusty environments), it's recommended to test in shorter intervalls (e.g. monthly).
- Pressing the test key "T" serves the only purpose of function testing the residual current device (RCD). This test does not make earthing resistance measurement (R_E), or proper checking of the earth conductor condition redundant, which must be performed separately.
- **Type -A:** Protects against special forms of residual pulsating DC which have not been smoothed.
- **Type -G:** High reliability against unwanted tripping. Suitable for any circuit where personal injury or damage to property may occur in case of unwanted tripping.
- **Type -G/A:** Additionally protects against special forms of residual pulsating DC which have not been smoothed Special types for X-ray application PF7-...-R.
- **Type -S:** Selective residual current device sensitive to AC, type -S. Suitable for systems with surge arresters downstream of the RCD.
- **Type -S/A:** Additionally protects against special forms of residual pulsating DC which have not been smoothed.

Accessories:

Auxiliary switch for subsequent installation to the left	Z-HK	248432
Tripping signal contact for subsequent installation to the right	Z-NHK	248434
Remote control and automatic switching device	Z-FW/LP	248296
Sealing cover set	Z-RC/AK-2TE	285385
	Z-RC/AK-4 MU	101062

Technical Data

		PF7	
Electrical			
Design according to		IEC/EN 61008 Type G according to ÖVE E 8601	
Current test marks as printed onto the device			
Tripping		instantaneous	
Type G		10 ms delay	
Type S		40 ms delay - selective disconnecting function	
Rated voltage	U_n	230/400 V AC, 50 Hz	
Rated tripping current	$I_{\Delta n}$	10, 30, 100, 300, 500 mA	
Sensitivity		AC and pulsating DC	
Rated insulation voltage	U_i	440 V	
Rated impulse withstand voltage	U_{imp}	4 kV (1.2/50 μ s)	
Rated short-circuit strength	I_{cn}	10 kA	
Maximum back-up fuse PF7			
Rating	Fuses	MCB's (Characteristic B/C)	
I_n [A]	Short-circuit [A]	Overload [A]	Short-circuit [A]
16	63 gG/gI	10 gG/gI	–
25	63 gG/gI	16 gG/gI	C20
40	63 gG/gI	25 gG/gI	C25
63	63 gG/gI	40 gG/gI	C40
80	80 gG/gI	50 gG/gI	–
100	100 gG/gI	63 gG/gI	–
Rated breaking capacity		I_m	
Rated fault breaking capacity		$I_{\Delta m}$	
$I_n = 16-40$ A			500 A
$I_n = 63$ A			630 A
$I_n = 80$ A			800 A
$I_n = 100$ A			1000 A
Voltage range of test button			
2-pole			196 - 264 V~
4-pole 30 mA			196 - 264 V~
4-pole 10, 100, 300, 500 mA			196 - 456 V~
Endurance			
electrical components			$\geq 4,000$ switching operations
mechanical components			$\geq 20,000$ switching operations
Mechanical			
Frame size		45 mm	
Device height		80 mm	
Device width		35 mm (2 MU), 70 mm (4 MU)	
Mounting		quick fastening with 2 lock-in positions on DIN rail IEC/EN 60715	
Degree of protection, built-in		IP40	
Degree of protection in moisture-proof enclosure		IP54	
Upper and lower terminals		open-mouthed/lift terminals	
Terminal protection		finger and hand touch safe, DGUV VS3, EN 50274	
Terminal capacity		1x (1.5 - 35) mm ² single wire 2x (1.5 - 16) mm ² multi wire	
Busbar thickness		0.8 - 2 mm	
Operating temperature		-25°C to +40°C	
Storage- and transport temperature		-35°C to +60°C	
Resistance to climatic conditions		25-55°C/90-95% relative humidity according to IEC 60068-2	

Connection diagrams

2-pole

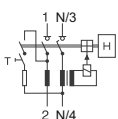

4-pole

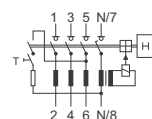

Dimensions (mm)

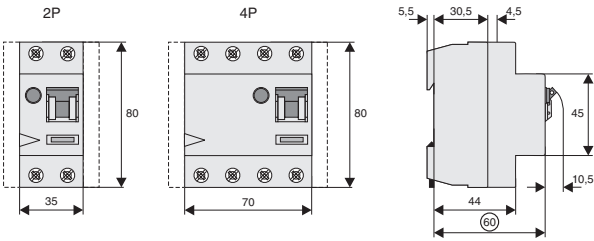

Correct connection

2-pole

30, 100, 300, 500 mA types:

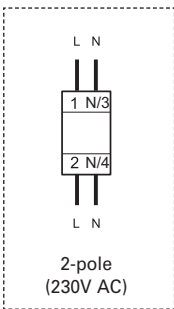

4-pole

30 mA types:

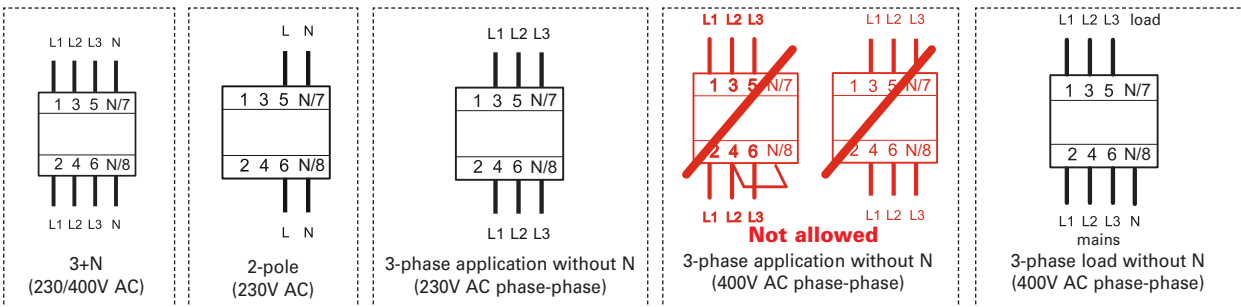

10, 100, 300, 500 mA types:

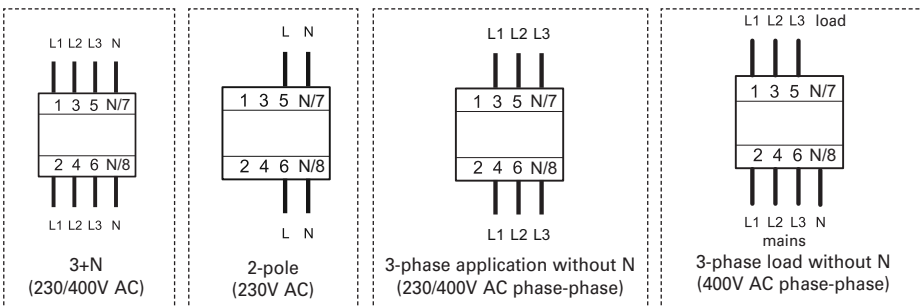

Influence of the ambient temperature to the maximum continuous current (A)

Ambient temperature	16A	25A	40A		63A		80A		100A
	2p	2p	4p	2p	4p	2p	4p	4p	4p
40°	16	25	25	40	40	63	63	80	100
45°	14	21	22	37	37	59	59	76	95
50°	11	18	19	33	34	55	55	72	90
55°	9	14	16	30	31	50	50	68	85
60°	—*)	—*)	—*)	26	27	45	45	64	80

Annotation: It has to be ensured that the values in the table are not exceeded and the back-up fuse/thermal protection works properly.

*) not applicable

SG80011



Description

- Economy series of RCD
- Rated short-circuit strength 6 kA
- For fault current/residual current protection and additional protection
- Comprehensive range of accessories can be mounted subsequently
- Frost resistance 

$I_n/I_{\Delta n}$ (A)	Type Designation	Article No.	Units per package
---------------------------	---------------------	-------------	----------------------

Type AC

Conditionally surge current-proof 250 A, type AC 

SG79411



2-pole

16/0.01	PF6-16/2/001	165756	1/60
16/0.03	PF6-16/2/003	119429	1/60
25/0.03	PF6-25/2/003	286492	1/60
25/0.10	PF6-25/2/01	286493	1/60
25/0.30	PF6-25/2/03	286494	1/60
25/0.50	PF6-25/2/05	286495	1/60
40/0.03	PF6-40/2/003	286496	1/60
40/0.10	PF6-40/2/01	286497	1/60
40/0.30	PF6-40/2/03	286498	1/60
40/0.50	PF6-40/2/05	286499	1/60
63/0.03	PF6-63/2/003	286500	1/60
63/0.10	PF6-63/2/01	286501	1/60
63/0.30	PF6-63/2/03	286502	1/60
63/0.50	PF6-63/2/05	286503	1/60
80/0.03	PF6-80/2/003	165790	1/60
80/0.10	PF6-80/2/01	165791	1/60
80/0.30	PF6-80/2/03	165792	1/60
80/0.50	PF6-80/2/05	165793	1/60

SG80011



4-pole

25/0.03	PF6-25/4/003	286504	1/30
25/0.10	PF6-25/4/01	286505	1/30
25/0.30	PF6-25/4/03	286506	1/30
25/0.50	PF6-25/4/05	286507	1/30
40/0.03	PF6-40/4/003	286508	1/30
40/0.10	PF6-40/4/01	286509	1/30
40/0.30	PF6-40/4/03	286510	1/30
40/0.50	PF6-40/4/05	286511	1/30
63/0.03	PF6-63/4/003	286512	1/30
63/0.10	PF6-63/4/01	286513	1/30
63/0.30	PF6-63/4/03	286514	1/30
63/0.50	PF6-63/4/05	286515	1/30
80/0.03	PF6-80/4/003	165795	1/30
80/0.10	PF6-80/4/01	165796	1/30
80/0.30	PF6-80/4/03	165799	1/30
80/0.50	PF6-80/4/05	165802	1/30

$I_n/I_{\Delta n}$ (A)	Type Designation	Article No.	Units per package
---------------------------	---------------------	-------------	----------------------

Type A

Conditionally surge current-proof 250 A, sensitive to residual pulsating DC, type A 

SG79411



2-pole

16/0.01	PF6-16/2/001-A	165755	1/60
16/0.03	PF6-16/2/003-A	165757	1/60
25/0.03	PF6-25/2/003-A	112921	1/60
25/0.10	PF6-25/2/01-A	112922	1/60
25/0.30	PF6-25/2/03-A	112923	1/60
40/0.03	PF6-40/2/003-A	112924	1/60
40/0.10	PF6-40/2/01-A	112925	1/60
40/0.30	PF6-40/2/03-A	112926	1/60
40/0.50	PF6-40/2/05-A	165770	1/60
63/0.03	PF6-63/2/003-A	112927	1/60
63/0.10	PF6-63/2/01-A	112928	1/60
63/0.30	PF6-63/2/03-A	112929	1/60
63/0.50	PF6-63/2/05-A	165779	1/60

SG80011



4-pole

25/0.03	PF6-25/4/003-A	112930	1/30
25/0.10	PF6-25/4/01-A	112931	1/30
25/0.30	PF6-25/4/03-A	112932	1/30
25/0.50	PF6-25/4/05-A	165763	1/30
40/0.03	PF6-40/4/003-A	112933	1/30
40/0.10	PF6-40/4/01-A	112934	1/30
40/0.30	PF6-40/4/03-A	112935	1/30
40/0.50	PF6-40/4/05-A	165778	1/30
63/0.03	PF6-63/4/003-A	112936	1/30
63/0.10	PF6-63/4/01-A	112937	1/30
63/0.30	PF6-63/4/03-A	112938	1/30
63/0.50	PF6-63/4/05-A	165789	1/30
80/0.03	PF6-80/4/003-A	165794	1/30
80/0.30	PF6-80/4/03-A	165798	1/30

$I_n/I_{\Delta n}$ (A)	Type Designation	Article No.	Units per package
---------------------------	---------------------	-------------	----------------------

Type G

Surge current-proof 3 kA, type G (ÖVE E 8601) 

SG79411



2-pole

25/0.03	PF6-25/2/003-G	165758	1/60
25/0.10	PF6-25/2/01-G	165759	1/60
40/0.03	PF6-40/2/003-G	165764	1/60
40/0.10	PF6-40/2/01-G	165766	1/60

SG80011



4-pole

40/0.03	PF6-40/4/003-G	165772	1/30
40/0.10	PF6-40/4/01-G	165773	1/30
63/0.03	PF6-63/4/003-G	165781	1/30
63/0.10	PF6-63/4/01-G	165784	1/30

Type G/A

Surge current-proof 3 kA, sensitive to residual pulsating DC, type G/A (ÖVE E 8601) 

SG79411



2-pole

40/0.10	PF6-40/2/01-G/A	165765	1/60
---------	-----------------	--------	------

SG80011



4-pole

40/0.03	PF6-40/4/003-G/A	165771	1/30
63/0.03	PF6-63/4/003-G/A	165780	1/30
63/0.10	PF6-63/4/01-G/A	165783	1/30

$I_n/\Delta n$ (A)	Type Designation	Article No.	Units per package
-----------------------	---------------------	-------------	----------------------

Type R

Surge current-proof 3 kA, X-ray application, type R

SG80011



4-pole

63/0.03	PF6-63/4/003-R	165782	1/30
---------	----------------	--------	------

Type S

Selective + surge current-proof 5 kA, type S

SG79411



2-pole

40/0.10	PF6-40/2/01-S	165768	1/60
40/0.30	PF6-40/2/03-S	165769	1/60

SG80011



4-pole

25/0.10	PF6-25/4/01-S	165761	1/30
25/0.30	PF6-25/4/03-S	165762	1/30
40/0.10	PF6-40/4/01-S	165775	1/30
40/0.30	PF6-40/4/03-S	165777	1/30
63/0.10	PF6-63/4/01-S	165786	1/30
63/0.30	PF6-63/4/03-S	165788	1/30
80/0.10	PF6-80/4/01-S	165797	1/30
80/0.30	PF6-80/4/03-S	165801	1/30

Type S/A

Selective + surge current-proof 5 kA, sensitive to residual pulsating DC, type S/A

SG79411



2-pole

40/0.10	PF6-40/2/01-S/A	165767	1/60
---------	-----------------	--------	------

SG80011



4-pole

25/0.10	PF6-25/4/01-S/A	165760	1/30
40/0.10	PF6-40/4/01-S/A	165774	1/30
40/0.30	PF6-40/4/03-S/A	165776	1/30
63/0.10	PF6-63/4/01-S/A	165785	1/30
63/0.30	PF6-63/4/03-S/A	165787	1/30
80/0.30	PF6-80/4/03-S/A	165800	1/30

Type	Type Designation	Article No.	Units per package
------	------------------	-------------	-------------------

Sealing Cover Set Z-RC/AK

- for PFIM, PFR, PF6, PF7, dRCM

SG82011



2-pole	Z-RC/AK-2TE	285385	10/30
4-pole	Z-RC/AK-4 MU	101062	10/600

Specifications | Residual Current Devices PF6

Description

- Twin-purpose terminal (lift/open-mouthed) above and below
- Busbar positioning optionally above or below
- Free terminal space despite installed busbar
- Universal tripping signal switch, also suitable for PLS., PKN., Z-A. can be mounted subsequently
- Auxiliary switch Z-HK can be mounted subsequently
- Contact position indicator red - green
- Delayed types suitable for being used with standard fluorescent tubes with or without electronical ballast (30mA-RCD: 30 units per phase conductor, 100mA-RCD: 90 units per phase conductor).
Notes: Depending of the fluorescent lamp ballast manufacturer partly more possible. Symmetrical allocation of the fluorescent lamp ballasts on all phases favourably. Shifting references of the fluorescent lamp ballast manufacturer consider.
- The device functions irrespective of the position of installation
- Tripping is line voltage-independent. Consequently, the RCD is suitable for "fault current/residual current protection" and "additional protection" within the the meaning of the applicable installation rules
- Mains connection at either side
- The 4-pole device can also be used for 2- or 3-pole connection. See connection possibilities.
- The test key "T" must be pressed every 6 month. The system operator must be informed of this obligation and his responsibility in a way that can be proven (self-adhesive RCD-label enclosed). The test intervall of 6 month is valid for residential and similar applications. Under all other conditions (e.g. damply or dusty environments), it's recommended to test in shorter intervalls (e.g. monthly).
- Pressing the test key "T" serves the only purpose of function testing the residual current device (RCD). This test does not make earthing resistance measurement (R_E), or proper checking of the earth conductor condition redundant, which must be performed separately.
- **Type -A:** Protects against special forms of residual pulsating DC which have not been smoothed.
- **Type -G:** High reliability against unwanted tripping. Suitable for any circuit where personal injury or damage to property may occur in case of unwanted tripping.
- **Type -G/A:** Additionally protects against special forms of residual pulsating DC which have not been smoothed. Special types for X-ray application PFIM-...-R.
- **Type -R:** To avoid unwanted tripping due to X-ray devices.
- **Type -S:** Selective residual current device sensitive to AC, type -S. Suitable for systems with surge arresters downstream of the RCD.
- **Type -S/A:** Additionally protects against special forms of residual pulsating DC which have not been smoothed.

Accessories:

Auxiliary switch for subsequent installation to the left	Z-HK	248432
Tripping signal contact for subsequent installation to the right	Z-NHK	248434
Remote control and automatic switching device	Z-FW/LP	248296
Sealing cover set	Z-RC/AK-2TE	285385
	Z-RC/AK-4 MU	101062

Technical Data

		PF6
Electrical		
Design according to		IEC/EN 61008 Type G according to ÖVE E 8601
Current test marks as printed onto the device		
Tripping		instantaneous
Type G, R		10 ms delay
Type S		40 ms delay - selective disconnecting function
Rated voltage	U_n	230/400 V AC, 50 Hz
Rated tripping current	$I_{\Delta n}$	10, 30, 100, 300, 500 mA
Sensitivity		AC and pulsating DC
Rated insulation voltage	U_i	440 V
Rated impulse withstand voltage	U_{imp}	4 kV (1.2/50 μ s)
Rated short-circuit strength	I_{cn}	10 kA
Maximum back-up fuse PF6		

Rating	Fuses		MCB's (Characteristic B/C)	
I_n [A]	Short-circuit [A]	Overload [A]	Short-circuit [A]	Overload [A]
16	63 gG/gI	10 gG/gI	–	–
25	63 gG/gI	16 gG/gI	C20	C20
40	63 gG/gI	25 gG/gI	C25	C25
63	63 gG/gI	40 gG/gI	C40	C40
80	80 gG/gI	50 gG/gI	–	–

Important: In the case that the maximal possible operating current of the electrical installation don't exceed the rated current of the RCD only short-circuit protection must be implemented. Overload protection must be implemented in the case if the maximal possible operating current of the electrical installation can exceed the rated current of the RCD.

Rated breaking capacity	I_m	
Rated fault breaking capacity	$I_{\Delta m}$	
$I_n = 16-40$ A		500 A
$I_n = 63$ A		630 A
$I_n = 80$ A		800 A

Voltage range of test button		
2-pole		196 - 264 V~
4-pole 30 mA		196 - 264 V~
4-pole 10, 100, 300, 500 mA		196 - 456 V~

Endurance	
electrical components	$\geq 4,000$ switching operations
mechanical components	$\geq 20,000$ switching operations

Mechanical

Frame size	45 mm
Device height	80 mm
Device width	35 mm (2 MU), 70 mm (4 MU)
Mounting	quick fastening with 2 lock-in positions on DIN rail IEC/EN 60715
Degree of protection, built-in	IP40
Degree of protection in moisture-proof enclosure	IP54
Upper and lower terminals	open-mouthed/lift terminals
Terminal protection	finger and hand touch safe, DGUV VS3, EN 50274
Terminal capacity	1x (1.5 - 35) mm ² single wire 2x (1.5 - 16) mm ² multi wire
Busbar thickness	0.8 - 2 mm
Operating temperature	-25°C to +40°C
Storage- and transport temperature	-35°C to +60°C
Resistance to climatic conditions	25-55°C/90-95% relative humidity according to IEC 60068-2

Connection diagrams

2-pole

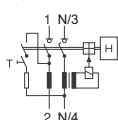

4-pole

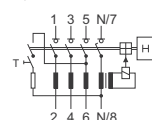

Dimensions (mm)

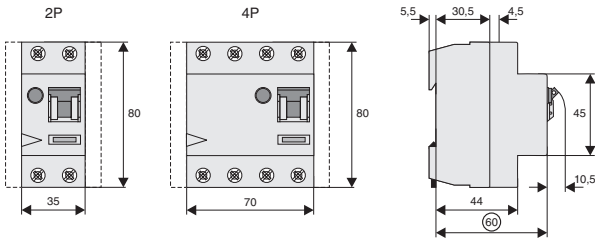

Correct connection

2-pole

30, 100, 300, 500 mA types:

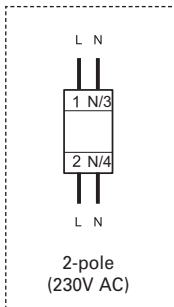

4-pole

30 mA types:

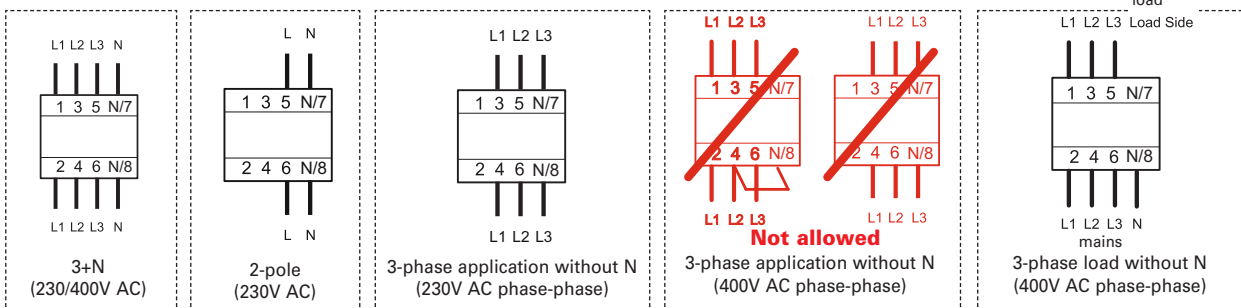

10, 100, 300, 500 mA types:

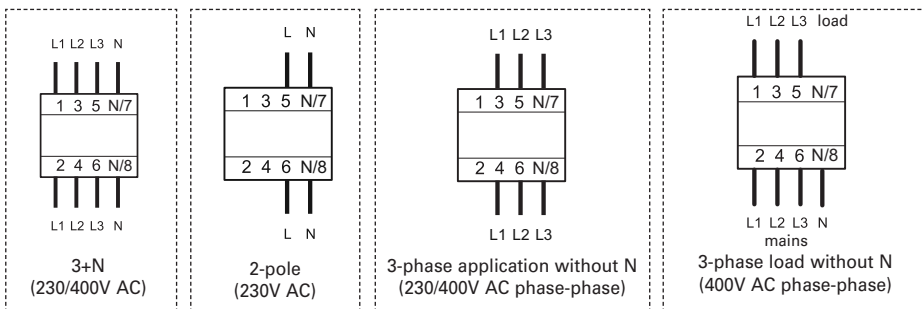

Influence of the ambient temperature to the maximum continuous current (A)

Ambient temperature	16A	25A	40A		63A		80A	
	2p	2p	4p	2p	4p	2p	4p	4p
40°	16	25	25	40	40	63	63	80
45°	14	21	22	37	37	59	59	76
50°	11	18	19	33	34	55	55	72
55°	9	14	16	30	31	50	50	68
60°	- *)	- *)	- *)	26	27	45	45	64

Annotation: It has to be ensured that the values in the table are not exceeded and the back-up fuse/thermal protection works properly.

*) not applicable

SG17311

SG47212

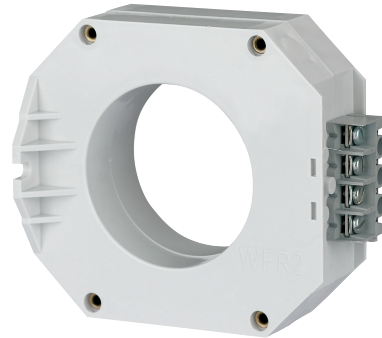

Description

- Especially matched residual current relays and core balance transformers
- Nominal fault currents 0.3 A and 1 A
- Standard (-S/A) and frequency converter-proof (-U) models
- Auxiliary switch can be mounted subsequently

$I_n/I_{\Delta n}$ (A)	Type Designation	Article No.	Units per package
---------------------------	---------------------	-------------	----------------------

Residual Current Relays PFR, type S/A

Selective + surge current-proof 5 kA, sensitive to residual pulsating DC, type S/A 

SG17311



0.30	PFR2-03-S/A	235864	1/30
0.30	PFR3-03-S/A	235865	1/30
1	PFR2-1-S/A	235866	1/30
1	PFR3-1-S/A	235867	1/30

Maximum cable lead-through diameter (mm)	Type Designation	Article No.	Units per package
---	---------------------	-------------	----------------------

Core Balance Transformers for PFR-S/A

SG47112



60	Z-WFR 2-S/A	236981	1
130	Z-WFR 3-S/A	236982	1

$I_n/I_{\Delta n}$ (A)	Type Designation	Article No.	Units per package
---------------------------	---------------------	-------------	----------------------

Residual Current Relays PFR, type U

Selective + surge current-proof 5 kA, frequency converter-proof, type U 

SG17211



0.30	PFR2-03-U	235868	1/30
0.30	PFR3-03-U	235869	1/30
1	PFR2-1-U	235870	1/30
1	PFR3-1-U	235871	1/30

Maximum cable lead-through diameter (mm)	Type Designation	Article No.	Units per package
---	---------------------	-------------	----------------------

Core Balance Transformers for PFR-U

SG47112



60	Z-WFR 2-U	104386	1
130	Z-WFR 3-U	104387	1

Type	Type Designation	Article No.	Units per package
------	---------------------	-------------	----------------------

Sealing Cover Set Z-RC/AK

- for PFIM, PFR, PF6, PF7, CF16, dRCM

SG82011



2-pole	Z-RC/AK-2TE	285385	10/30
4-pole	Z-RC/AK-4 MU	101062	10/600

Specifications | Residual Current Relays PFR, Core Balance Transformers Z-WFR

Description

- Residual Current Relays
- Shape compatible with and suitable for standard busbar connection to other devices of the P-series
- Universal tripping signal switch, also suitable for PLS., PKN., Z-A. can be mounted subsequently
- Auxiliary switch Z-HK can be mounted subsequently
- Contact position indicator red - green
- Delayed types suitable for being used with standard fluorescent tubes with or without electronic ballast (30mA-RCD: 30 units per phase conductor, 100mA-RCD: 90 units per phase conductor).
Notes: Depending of the fluorescent lamp ballast manufacturer partly more possible. Symmetrical allocation of the fluorescent lamp ballasts on all phases favourably. Shifting references of the fluorescent lamp ballast manufacturer consider.
- The test key "T" must be pressed every 6 month. The system operator must be informed of this obligation and his responsibility in a way that can be proven (self-adhesive RCD-label enclosed). The test intervall of 6 month is valid for residential and similar applications. Under all other conditions (e.g. damply or dusty environments), it's recommended to test in shorter intervalls (e.g. monthly).
- Type -U:** Suitable for speed-controlled drives with frequency converters in household, trade, and industry. Unwanted tripping is avoided thanks to a tripping characteristic designed particularly for frequency converters.

Accessories:

Auxiliary switch for subsequent installation to the left	Z-HK	248432
Tripping signal contact for subsequent installation to the right	Z-NHK	248434
Sealing cover set	Z-RC/AK-4 MU	101062

Technical Data

		PFR
Electrical		
Design according to		IEC/EN 61008
Current test marks as printed onto the device		
Tripping		40 ms delay - selective disconnecting function
Rated voltage	U_n	230/400 V AC, 50 Hz
Rated tripping current	$I_{\Delta n}$	(0.1) ¹⁾ , 0.3 and 1 A
Rated current of relay contacts		25 A / 400 V~, 16 A / 230 V AC 15
Max. Nennstrom		400 A
Sensitivity		pulsating DC
Rated impulse withstand voltage	U_{imp}	4 kV (1.2/50 μ s)
Voltage range of test button		184 - 440 V~
Endurance		
electrical components		$\geq 4,000$ switching operations
mechanical components		$\geq 20,000$ switching operations
Mechanical		
Frame size		45 mm
Device height		80 mm
Device width		70 mm (4 MU)
Mounting		quick fastening with 2 lock-in positions on DIN rail IEC/EN 60715
Degree of protection, built-in		IP40
Upper and lower terminals		open-mouthed/lift terminals
Terminal protection		finger and hand touch safe, DGUV VS3, EN 50274
Terminal capacity		1.5 - 35 mm ² single wire 2 x 16 mm ² multi wire
Busbar thickness		0.8 - 2 mm
Control line		1.5 - 2.5 mm ²
Operating temperature		-25°C to +40°C
Storage- and transport temperature		-35°C to +60°C
Resistance to climatic conditions		25-55°C/90-95% relative humidity according to IEC 60068-2

¹⁾ see Important Information for Installation

Connection diagrams

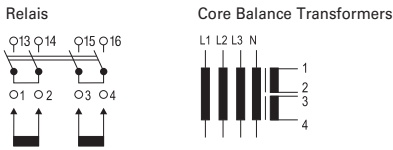

Dimensions (mm)

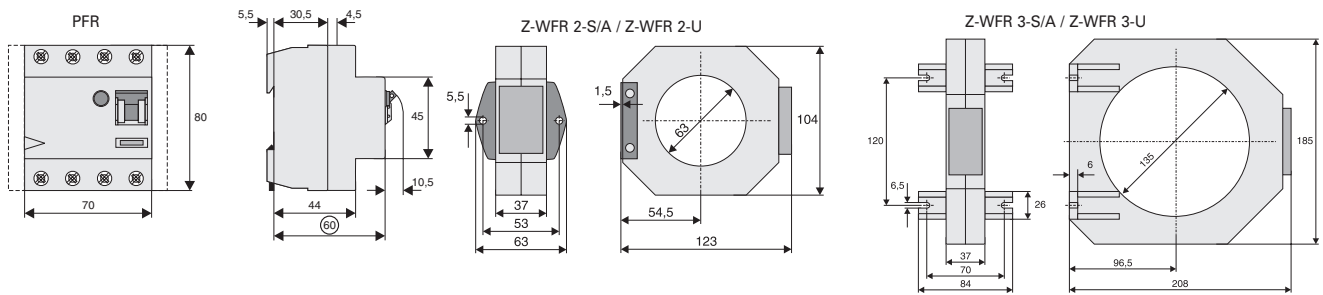

Important Information for Installation

All lines required for operation, L1, L2, and L3 including neutral N, must be routed through the transformer as follows:

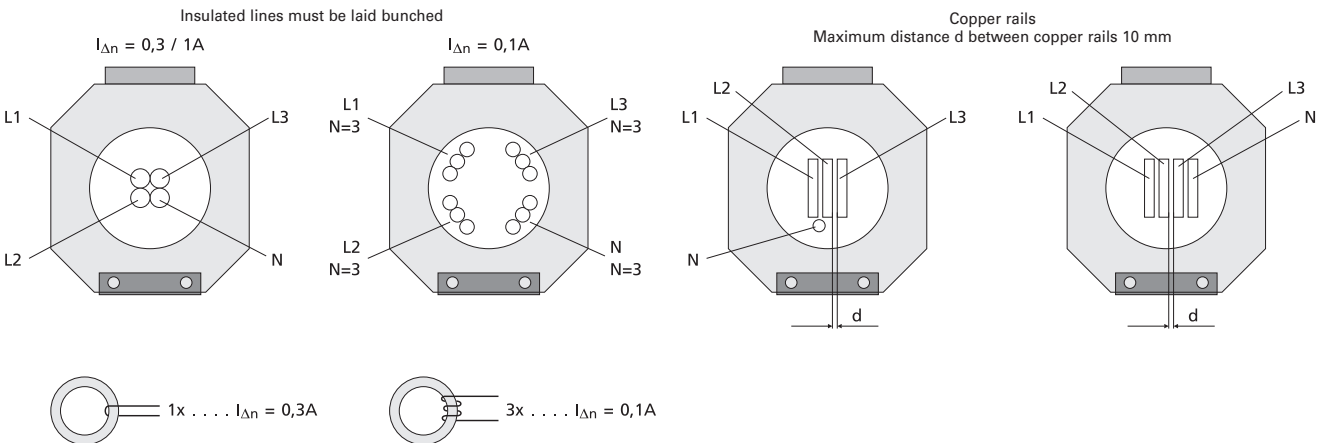

Impulse Contact Control

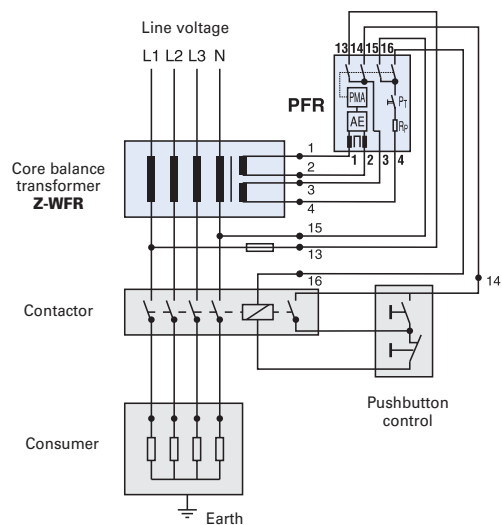

Continuous Contact Control

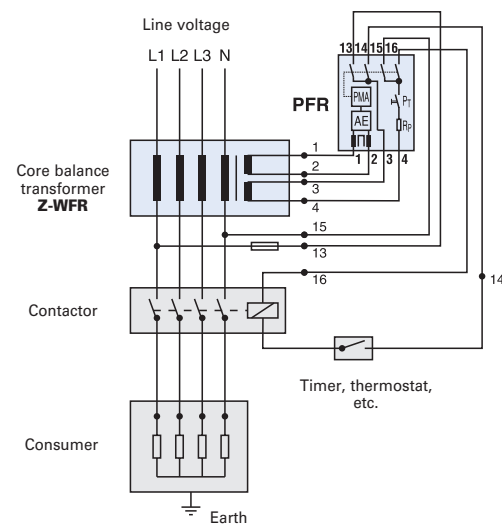

Two possible switching examples.

- Attention:**
- Connect terminals 1-4 of the relay to the terminals 1-4 of the transformer (see switching examples)!
 - 1+2: secondary winding; 3+4: test winding
 - Supply terminals 13 and 15 as shown, so that the test circuit can work correctly!

Rated Tripping Current Matching

Matching of the rated tripping current, 0.1 or 0.3 A, is achieved by the number of turns in the primary winding of the transformer (in PFR2-03-S/A, PFR3-03-S/A, PFR2-03-U and PFR3-03-U).

Residual Current Relays	Transformer	Rated tripping current $I_{\Delta N}$ (A)	Number of primary turns	Maximum cable diameter (mm)	Maximum primary current (A)
PFR2-03-U (S/A)	Z-WFR2	0.1	3	60	150
		0.3	1	60	400
PFR3-03-U (S/A)	Z-WFR3	0.1	3	130	100
		0.3	1	130	400
PFR2-1-U (S/A)	Z-WFR2	1.0	1	60	400
PFR3-1-U (S/A)	Z-WFR3	1.0	1	130	400

SG31211



Description

- Reliable, universal monitoring of residual current
- RCD characteristic and sensitivity are freely selectable
- Compact design, with integrated transformer
- DIN mounting, compatible with shapes and standard busbar connections of other Xpole devices
- Local status indication of residual current through 3 LEDs
- 2 potential-free signalling contacts

$I_n/I_{\Delta n}$
(A)

Type
Designation

Article No. Units per
package

Leakage Current Monitor PDIM

 , instantaneous, **G** , **S** => adjustable

4-pole

40/0.03; 0.1; 0.3; 0.5; 1	PDIM-40/4	111760	1/30
100/0.03; 0.1; 0.3; 0.5; 1	PDIM-100/4	111761	1/30

SG31211



Specifications | Leakage Current Monitor PDIM

Description

- Shape compatible with and suitable for standard busbar connection to other devices of the P-series
- Twin-purpose terminal (lift/open-mouthed) above and below
- Busbar positioning optionally above or below
- Free terminal space despite installed busbar
- Power supply via 'OR' disjunction of the 4 conductors
- Electronic functioning (line-voltage dependent)
- The device functions irrespective of the position of installation
- Mains connection at either side
- The 4-pole device can also be used for 3-pole connection.
For this purpose use terminals 1-2, 3-4, and 5-6.
- The 4-pole switch can also be used as a 2-pole switch
For this purpose use terminals 5-6 and N-N.
- 2 potential-free relays (make contact, in parallel with the yellow and red LED)
(up to 10 A / 230 V~)

Functioning

- The green LED becomes active at 0-30% of the preset $I_{\Delta n}$.
The yellow LED becomes active at 30-50% of the preset $I_{\Delta n}$.
The red LED becomes active at >50% of the preset $I_{\Delta n}$.
- The yellow LED turns off again when the identified residual current is <30% of the preset $I_{\Delta n}$.
- The red LED turns off again when the identified residual current is <50% of the preset $I_{\Delta n}$.
- Only one LED will be active at a time.
- An output relay will always be switched simultaneously with the yellow or red LED
- Depending on the setting of the type of RCD (instantaneous, G, S), the residual current needs to flow a sufficiently long time before an action is triggered.

Test function

- The rotary coding switch for the RCD switch function is to be set to "TEST".
The device then alternately simulates residual currents of 30% and 50% of the $I_{\Delta n}$. In this process, the yellow and red LED flash alternately (1 Hz), both output relays remain permanently energised.

Technical Data

		PDIM
Electrical		
Design similar to		DIN/EN 62020
Current test marks as printed onto the device		
Rated current	I_n	40 A, 100 A
Tripping behaviour (adjustable)		instantaneous
Type G		10 ms delay
Type S		40 ms delay - selective disconnecting function
Rated voltage	U_n	230/400 V, 50/60 Hz 240/415 V, 50/60 Hz
Rated tripping current (adjustable)	$I_{\Delta n}$	30, 100, 300, 500, 1000 mA
Sensitivity		AC and pulsating DC
Rated insulation voltage	U_i	440 V
Rated short-circuit strength	I_{cn}	10 kA
Maximum back-up fuse		Short-circuit Overload
$I_n = 40$ A		63 A gG/gL 40 A gG/gL
$I_n = 100$ A		100 A gG/gL 63 A gG/gL
In the case that the maximal possible operating current of the electrical installation don't exceed the rated current of the RCD only short-circuit protection must be implemented. Overload protection must be implemented in the case if the maximal possible operating current of the electrical installation can exceed the rated current of the RCD.		
Switching contacts		potential-free 10 A / 230 V~
ATripping behaviour of the contacts		
1		30-50% $I_{\Delta n}$
2		>50% $I_{\Delta n}$
Endurance		
electrical components		$\geq 4,000$ switching operations
mechanical components		$\geq 20,000$ switching operations
Mechanical		
Frame size		45 mm
Device height		80 mm
Device width		70 mm (4 MU)
Mounting		quick fastening with 2 lock-in positions on DIN rail IEC/EN 60715
Degree of protection, built-in		IP40
Degree of protection in moisture-proof enclosure		IP54
Upper and lower terminals		open-mouthed/lift terminals
Terminal protection		finger and hand touch safe, DGUV VS3, EN 50274
Terminal capacity (1, 2, 3, 4, 5, 6, N, N)		1.5 - 35 mm ² single wire 2 x 16 mm ² multi wire
Terminal capacity Switching contacts		0.25 - 1.5 mm ²
Busbar thickness		0.8 - 2 mm
Operating temperature		-25°C to +40°C
Storage- and transport temperature		-35°C to +60°C
Resistance to climatic conditions		25-55°C/90-95% relative humidity according to IEC 60068-2

Connection diagram

4-pole

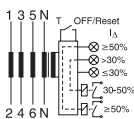

Dimensions (mm)

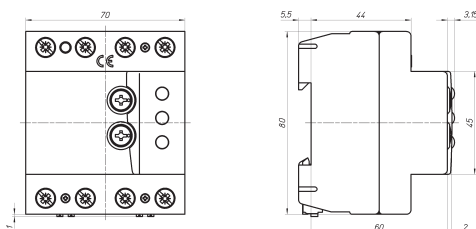

sg06416



Description

- Arc Fault Detection Device acc. to IEC/ EN-62606
- Detects and quenches arc faults in final circuits
- Fully combined with residual current circuit breaker (RCCB) and miniature circuit breaker (MCB)
- 2-pole: Both clearances between open contacts are protected
- Variable installation of N either to the left or right
- Rated currents from 6 to 40 A
- Contact position indicator red – green
- Tripped indication: MCB, RCCB or AFDD
- LED indication for arc faults
- Permanent self-monitoring
- Overvoltage and overheat monitoring
- Guide for secure terminal connection
- 3-position DIN rail clip, permits removal from existing busbar system
- Comprehensive range of accessories suitable for subsequent installation
- 10 and 30 mA rated residual currents
- Tripping characteristics B, C
- Rated breaking capacity up to 10 kA
- The -OL types are specifically designed to fulfill the tripping characteristic requirements of $I_2 \leq I_z$ in the Norwegian electrotechnical standard NEK 400-8-823.

$I_n/I_{\Delta n}$ (A)	Type Designation	Article No.	Units per package
---------------------------	---------------------	-------------	----------------------

Type F, 10 kA, 2-pole

Surge current-proof 3 kA, sensitive to residual pulsating DC, type F

Characteristic B

100L/0.03	AFDD-10/2/B/003-F-OL	MB-300184	1/40
130L/0.03	AFDD-13/2/B/003-F-OL	MB-300185	1/40
150L/0.03	AFDD-15/2/B/003-F-OL	MB-300186	1/40
200L/0.03	AFDD-20/2/B/003-F-OL	MB-300187	1/40
10/0.03	AFDD-10/2/B/003-F	187243	1/40
13/0.03	AFDD-13/2/B/003-F	187253	1/40
16/0.03	AFDD-16/2/B/003-F	187263	1/40
20/0.03	AFDD-20/2/B/003-F	187272	1/40
25/0.03	AFDD-25/2/B/003-F	187278	1/40

Characteristic C

100L/0.03	AFDD-10/2/C/003-F-OL	MB-300179	1/40
130L/0.03	AFDD-13/2/C/003-F-OL	MB-300180	1/40
150L/0.03	AFDD-15/2/C/003-F-OL	MB-300181	1/40
200L/0.03	AFDD-20/2/C/003-F-OL	MB-300182	1/40
6/0.03	AFDD-6/2/C/003-F	MB-300178	1/40
10/0.03	AFDD-10/2/C/003-F	187249	1/40
13/0.03	AFDD-13/2/C/003-F	187259	1/40
16/0.03	AFDD-16/2/C/003-F	187269	1/40
20/0.03	AFDD-20/2/C/003-F	187275	1/40
25/0.03	AFDD-25/2/C/003-F	187281	1/40

Type F, 6 kA, 2-pole

Surge current-proof 3 kA, sensitive to residual pulsating DC, type F

Characteristic B

32/0.03	AFDD-32/2/B/003-F	187284	1/40
40/0.03	AFDD-40/2/B/003-F	187290	1/40

Characteristic C

32/0.03	AFDD-32/2/C/003-F	187287	1/40
40/0.03	AFDD-40/2/C/003-F	187293	1/40

sg06416



sg06416



$I_n/I_{\Delta n}$ (A)	Type Designation	Article No.	Units per package
---------------------------	---------------------	-------------	----------------------

Type G/A, 10 kA, 2-pole

Surge current-proof 3 kA, sensitive to residual pulsating DC, type G/A

Characteristic B

10/0.01	AFDD-10/2/B/001-G/A	MB-300194	1/40
13/0.01	AFDD-13/2/B/001-G/A	MB-300195	1/40
16/0.01	AFDD-16/2/B/001-G/A	MB-300196	1/40
10/0.03	AFDD-10/2/B/003-G/A	MB-300162	1/40
13/0.03	AFDD-13/2/B/003-G/A	MB-300165	1/40
16/0.03	AFDD-16/2/B/003-G/A	MB-300168	1/40
20/0.03	AFDD-20/2/B/003-G/A	MB-300170	1/40
25/0.03	AFDD-25/2/B/003-G/A	MB-300173	1/40

Characteristic C

6/0.01	AFDD-6/2/C/001-G/A	MB-300188	1/40
10/0.01	AFDD-10/2/C/001-G/A	MB-300189	1/40
13/0.01	AFDD-13/2/C/001-G/A	MB-300191	1/40
16/0.01	AFDD-16/2/C/001-G/A	MB-300192	1/40
6/0.03	AFDD-6/2/C/003-G/A	MB-300138	1/40
10/0.03	AFDD-10/2/C/003-G/A	MB-300147	1/40
13/0.03	AFDD-13/2/C/003-G/A	MB-300149	1/40
16/0.03	AFDD-16/2/C/003-G/A	MB-300152	1/40
20/0.03	AFDD-20/2/C/003-G/A	MB-300153	1/40
25/0.03	AFDD-25/2/C/003-G/A	MB-300155	1/40

Type G/A, 6 kA, 2-pole

Surge current-proof 3 kA, sensitive to residual pulsating DC, type G/A

Characteristic B

32/0.03	AFDD-32/2/B/003-G/A	MB-300174	1/40
40/0.03	AFDD-40/2/B/003-G/A	MB-300222	1/40

Characteristic C

32/0.03	AFDD-32/2/C/003-G/A	MB-300158	1/40
40/0.03	AFDD-40/2/C/003-G/A	MB-300159	1/40

sg06416



sg06416



$I_n/I_{\Delta n}$ (A)	Type Designation	Article No.	Units per package
---------------------------	---------------------	-------------	----------------------

Type A, 10 kA, 2-pole

Non-delayed, sensitive to residual pulsating DC, type A

Characteristic B

10/0.01	AFDD-10/2/B/001-A	187165	1/40
100L/0.03	AFDD-10/2/B/003-A-OL	MB-300217	1/40
130L/0.03	AFDD-13/2/B/003-A-OL	MB-300221	1/40
13/0.01	AFDD-13/2/B/001-A	187177	1/40
16/0.01	AFDD-16/2/B/001-A	187201	1/40
10/0.03	AFDD-10/2/B/003-A	187168	1/40
13/0.03	AFDD-13/2/B/003-A	187180	1/40
150L/0.03	AFDD-15/2/B/003-A-OL	187192	1/40
16/0.03	AFDD-16/2/B/003-A	187204	1/40
200L/0.03	AFDD-20/2/B/003-A-OL	187213	1/40
20/0.03	AFDD-20/2/B/003-A	187219	1/40
25/0.03	AFDD-25/2/B/003-A	187225	1/40

Characteristic C

6/0.01	AFDD-6/2/C/001-A	MB-300206	1/40
10/0.01	AFDD-10/2/C/001-A	187171	1/40
100L/0.03	AFDD-10/2/C/003-A-OL	MB-300215	1/40
130L/0.03	AFDD-13/2/C/003-A-OL	MB-300216	1/40
13/0.01	AFDD-13/2/C/001-A	187183	1/40
16/0.01	AFDD-16/2/C/001-A	187207	1/40
6/0.03	AFDD-6/2/C/003-A	MB-300199	1/40
10/0.03	AFDD-10/2/C/003-A	187174	1/40
13/0.03	AFDD-13/2/C/003-A	187186	1/40
150L/0.03	AFDD-15/2/C/003-A-OL	187198	1/40
16/0.03	AFDD-16/2/C/003-A	187210	1/40
200L/0.03	AFDD-20/2/C/003-A-OL	187216	1/40
20/0.03	AFDD-20/2/C/003-A	187222	1/40
25/0.03	AFDD-25/2/C/003-A	187228	1/40

Type A, 6 kA, 2-pole

Non-delayed, sensitive to residual pulsating DC, type A

Characteristic B

32/0.03	AFDD-32/2/B/003-A	187231	1/40
40/0.03	AFDD-40/2/B/003-A	187237	1/40

Characteristic C

32/0.03	AFDD-32/2/C/003-A	187234	1/40
40/0.03	AFDD-40/2/C/003-A	187240	1/40

sg06416



sg06416



$I_n/I_{\Delta n}$ (A)	Type Designation	Article No.	Units per package
---------------------------	---------------------	-------------	----------------------

Type AC, 10 kA, 2-pole

Non-delayed, alternating-current-sensitive, type AC

Characteristic B

10/0.01	AFDD-10/2/B/001	187164	1/40
13/0.01	AFDD-13/2/B/001	187176	1/40
16/0.01	AFDD-16/2/B/001	187200	1/40
10/0.03	AFDD-10/2/B/003	187167	1/40
13/0.03	AFDD-13/2/B/003	187179	1/40
16/0.03	AFDD-16/2/B/003	187203	1/40
20/0.03	AFDD-20/2/B/003	187218	1/40
25/0.03	AFDD-25/2/B/003	187224	1/40

Characteristic C

6/0.01	AFDD-6/2/C/001	MB-300205	1/40
10/0.01	AFDD-10/2/C/001	187170	1/40
13/0.01	AFDD-13/2/C/001	187182	1/40
16/0.01	AFDD-16/2/C/001	187206	1/40
6/0.03	AFDD-6/2/C/003	MB-300197	1/40
10/0.03	AFDD-10/2/C/003	187173	1/40
13/0.03	AFDD-13/2/C/003	187185	1/40
16/0.03	AFDD-16/2/C/003	187209	1/40
20/0.03	AFDD-20/2/C/003	187221	1/40
25/0.03	AFDD-25/2/C/003	187227	1/40

Type AC, 6 kA, 2-pole

Non-delayed, alternating-current-sensitive, type AC

Characteristic B

32/0.03	AFDD-32/2/B/003	187230	1/40
40/0.03	AFDD-40/2/B/003	187236	1/40

Characteristic C

32/0.03	AFDD-32/2/C/003	187233	1/40
40/0.03	AFDD-40/2/C/003	187239	1/40

sg06416



sg06416



Specifications | Arc Fault Detection Device AFDD+, 2-pole

Description

- Arc Fault Detection Device acc. to IEC/EN-62606
- Line-voltage-independent RCBO (combined switch) acc. to IEC/EN 61009
- 2-pole: Both clearances between open contacts are protected
- Variable installation of N either to the left or the right
- Tripped indication: MCB, RCCB or AFDD
- LED indication for arc faults
- Compatible with standard busbar
- Twin-purpose terminal (lift/open-mouthed) above and below
- Busbar positioning optionally above or below
- Free terminal space despite installed busbar
- Guide for secure terminal connection
- Switching toggle (MCB component) in colour designating the rated current
- Contact position indicator red - green
- Comprehensive range of accessories can be mounted subsequently
- The test key "T" must be pressed every 6 months. The system operator must be informed of this obligation and their responsibility in a way that can be proven (self-adhesive RCD-label enclosed). The test interval of 6 months is valid for residential and similar applications. Under all other conditions (e.g. damp or dusty environments), it's recommended to test in shorter intervals (e.g. monthly).
- Pressing the test key "T" serves the only purpose of function testing the residual current device (RCD). This test does not perform an earthing resistance measurement (R_E), nor does it render the check of the earth conductor condition redundant, which means both tests must additionally be performed separately.
- The cable length (one-way) from the AFDD+ to the socket outlet should not exceed 70 m. This guarantees that arc faults can be detected reliably.
- **Type -A:** Protects against special forms of residual pulsating DC which have not been smoothed
- **Type -F:** Sensitive to pulsating DC residual current and detection of multi-frequency residual currents up to 1 kHz.
 - Increased protection due to the detection of mixed frequencies
 - Higher load rating with DC residual currents up to 10 mA
 - Reduction of nuisance tripping thanks to time delayed tripping and increased current withstand capability of 3 kA
 Recommended for washing machines, dish washers, or motor applications with single-phase drives.
- **Type -G/A:** Additionally protects against special forms of residual pulsating DC which have not been smoothed.
- **Type -G:** High reliability against unwanted tripping. Suitable for any circuit where personal injury or damage to property may occur in case of unwanted tripping. Additionally protects against special forms of residual pulsating DC which have not been smoothed.
- **OL types:** Specifically designed to fulfill the tripping characteristic requirements of $I_2 \leq I_z$ in the Norwegian electrotechnical standard NEK 400-8-823. 10:28.

Error memory:

The AFDD+ saves the last tripping reason/cause. If the device is in the open position (turned off), press and hold the test button "T" and simultaneously turn on the device. This causes the in-built LED to flash in a sequence that will reveal the tripping cause.

Accessories:

Auxiliary switch for subsequent installation	ZP-IHK	286052
Auxiliary switch	ZP-NHK	248437
	ZP-WHK	286053
Shunt trip release	ZP-ASA/..	248438, 248439
Busbars	EVG-2PHAS/4AFDD; ZV-SS; ZV-L1/N; ZV-L2/L3; ZV-ADP; ZV-AEK	

Technical Data

		AFDD+
Electrical		
Design according to		IEC/EN 62606
Relevant effective certification marks as printed onto the device		IEC/EN 61009 IEC/EN 62423 Type G acc. to ÖVE E 8601
Line voltage-independent tripping		instantaneous surge current proof 250 A (8/20 μ s) surge current proof 3 kA (F, -F-OL, -G/A, -G/A-OL) (8/20 μ s)
Rated voltage	U_n	240 V AC; 50 Hz
Operational voltage range		180-264 V
Self-consumption		< 0.8 W
Rated residual operating current	$I_{\Delta n}$	10, 30 mA
Rated residual non-operating current	$I_{\Delta no}$	0.5 $I_{\Delta n}$
Sensitivity		AC and pulsating DC, Type F
Selectivity class		3
Rated breaking capacity		
AFDD 6-25 A		10 kA
AFDD 32-40 A		6 kA
Rated current		6 - 40 A
Rated insulation voltage	U_i	440 V
Rated impulse withstand voltage	U_{imp}	4 kV (1.2/50 μ s)
Rated residual making and breaking capacity	$I_{\Delta m}$	
EN 61009		3 kA
IEC 61009		6-16 A: 3 kA 20-40 A: 500 A
Arc fault tripping times after load current (acc. to IEC/EN 62606)		
Load current (A)		Tripping time (s)
2,5		<1
5		<0.5
10		<0.25
16		<0.15
32		<0.12
40		<0.12
Characteristic		B, C, B(-OL), C(-OL)
Maximum back-up fuse (short-circuit)		100 A gL (>10 kA)
Endurance		
electrical components		$\geq 4,000$ switching operations
mechanical components		$\geq 20,000$ switching operations
Mechanical		
Frame size		45 mm
Device height		80 mm
Device width		54 mm (3 MU)
Mounting		3-position DIN rail clip, permits removal from existing busbar system
Degree of protection, switch		IP20
Degree of protection, built-in		IP40
Upper and lower terminals		open-mouthed/lift terminals
Terminal protection		finger and hand touch safe, EN 50274
Terminal cross section (capacity)		1 - 25 mm ²
Busbar thickness		0.8 - 2 mm
Operating temperature		-25° C to +40° C
Storage and transport temperature		-35° C to +60° C
Resistance to climatic conditions		according to IEC/EN 61009

Connection diagram

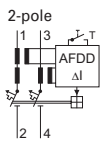

Dimensions (mm)

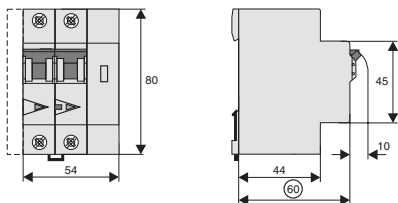

Tripping Characteristic AFDD+, Characteristics B and C

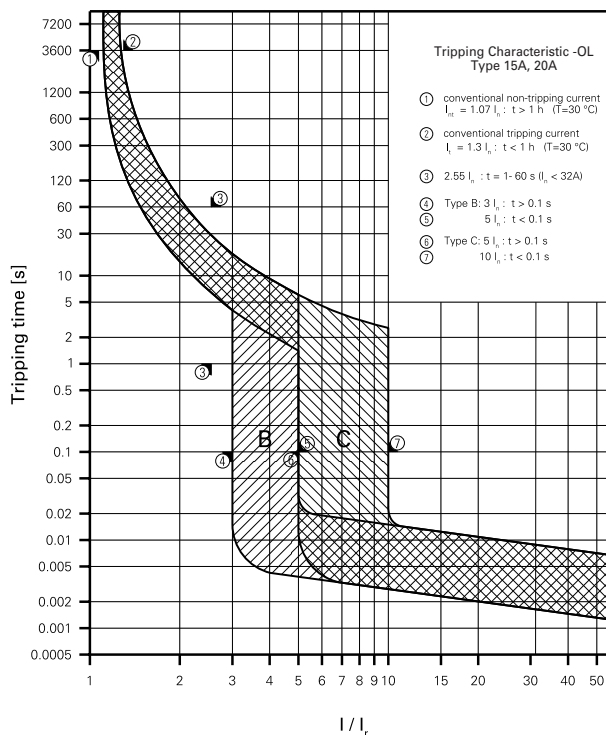
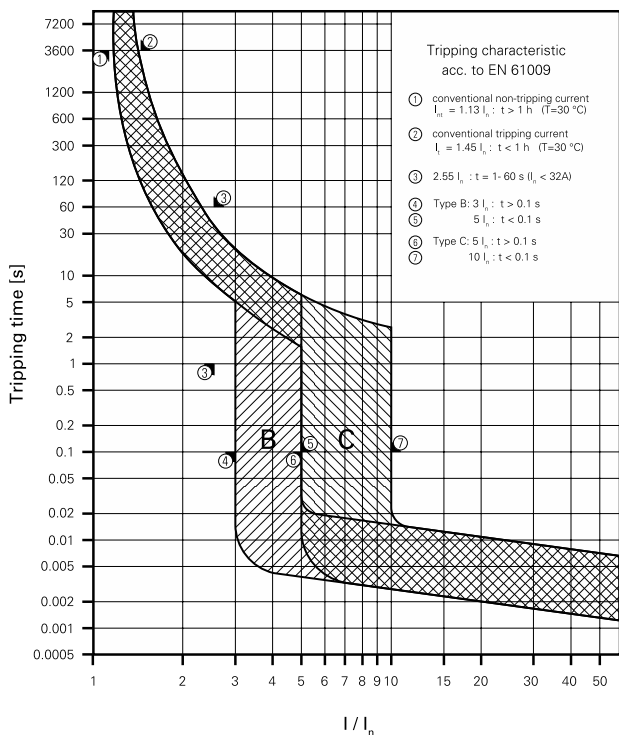

Declaration AFDD reason for tripping

After switching on the AFDD is initially a test LED (LED sequence red-yellow-green -> continuous green). Any previous arc tripping reasons are shown only one time after switching on again.

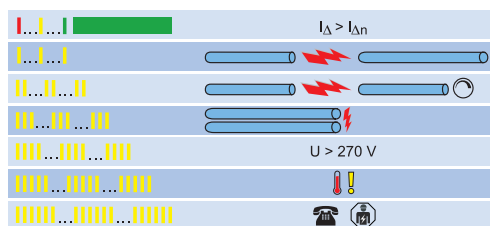

- Green, no arcing as tripping reason
- 1x yellow, serial arc
- 2x yellow, serial arc of a dimmed load
- 3x yellow, parallel arc
- 4x yellow, over voltage (about 270V) AFDD tripped for self protection
- 5x yellow, overtemperature in the device (about >115°C) AFDD tripped for self protection
- 6x yellow, device error, please check device by an expert

The last AFDD error can be reshown by pressing the test key while the device is switched on.

Short-circuit Selectivity AFDD+ 10-20 A towards Neozed¹⁾ / Diazed²⁾ / NH00³⁾

Short-circuit currents in kA, rated currents of fuses in A

Short-circuit selectivity **AFDD+** towards **Neozed¹⁾**

AFDD+	Neozed ¹⁾										
	I _n [A]	16	20	25	32	35	40	50	63	80	100
B10/B10-OL	<0.5	0.5	0.9	2	2.3	3.7	8	10	10	10	
B13/B13-OL	<0.5	0.5	0.8	1.7	1.9	3	6	10	10	10	
B16/B15-OL		0.5	0.7	1.5	1.7	2.4	4.4	6.8	10	10	
B20/B20-OL			0.7	1.4	1.5	2.2	3.9	6	9.2	10	
C10/C10-OL	<0.5	0.5	0.8	1.7	1.9	3	6.1	10	10	10	
C13/C13-OL	<0.5	0.5	0.7	1.6	1.8	2.8	5.5	9.5	10	10	
C16/B15-OL		<0.5	0.7	1.3	1.5	2.2	4	6.2	10	10	
C20/C20-OL			0.6	1.3	1.4	2.1	3.7	5.6	8.5	10	

Short-circuit selectivity **AFDD+** towards **Diazed²⁾**

AFDD+	Diazed ²⁾									
	I _n [A]	16	20	25	32	35	50	63	80	100
B10/B10-OL	<0.5	0.5	0.9	1.8	2.9	5.6	10	10	10	
B13/B13-OL	<0.5	0.5	0.8	1.5	2.4	4.5	10	10	10	
B16/B15-OL		0.5	0.8	1.3	2	3.4	8	10	10	
B20/B20-OL			0.7	1.3	1.9	3.1	7.1	10	10	
C10/C10-OL	<0.5	0.5	0.8	1.5	2.4	4.4	10	10	10	
C13/C13-OL	<0.5	0.5	0.8	1.4	2.3	4.2	10	10	10	
C16/B15-OL		<0.5	0.7	1.2	1.9	3.2	7.6	10	10	
C20/C20-OL			0.7	1.2	1.8	2.9	6.5	9.7	10	

Short-circuit selectivity **AFDD+** towards **NH00³⁾**

AFDD+	NH00 ³⁾												
	I _n [A]	16	20	25	32	35	40	50	63	80	100	125	160
B10/B10-OL	<0.5	<0.5	0.8	1.5	2.3	3.2	5.7	9.1	10	10	10	10	
B13/B13-OL	<0.5	<0.5	0.8	1.3	1.9	2.7	4.4	6.5	10	10	10	10	
B16/B15-OL		<0.5	0.7	1.1	1.6	2.2	3.4	4.8	8	10	10	10	
B20/B20-OL			0.6	1	1.4	2	3.1	4.3	7	10	10	10	
C10/C10-OL	<0.5	<0.5	0.7	1.3	1.9	2.7	4.5	6.9	10	10	10	10	
C13/C13-OL	<0.5	<0.5	0.7	1.2	1.8	2.5	4.1	6.1	10	10	10	10	
C16/B15-OL		<0.5	0.6	1	1.5	2	3.1	4.4	7.5	10	10	10	
C20/C20-OL			0.6	0.9	1.4	1.9	2.9	4.1	6.5	10	10	10	

Darker areas: no selectivity

¹⁾ SIEMENS Type 5SE2; Size: D01, D02, D03; Operating class gG; Rated voltage: AC 400 V/DC 250 V

²⁾ SIEMENS Type 5SB2, 5SB4, 5SC2; Size: DII, DIII, DIV; Operating class gG; Rated voltage: AC 500 V/DC 500 V

³⁾ SIEMENS Type 3NA3 8, 3NA6 8, 3NA7 8; Size: 000, 00; Operating class gG; Rated voltage: AC 500 V/DC 250 V

Short-circuit Selectivity AFDD+ 25-40 A towards Neozed¹⁾ / Diazed²⁾ / NH00³⁾

Short-circuit currents in kA, rated currents of fuses in A

Short-circuit selectivity **AFDD+** towards **Neozed¹⁾**

AFDD+	Neozed ¹⁾										
	I _n [A]	16	20	25	32	35	40	50	63	80	100
B25				1.2	1.3	1.8	3.1	4.7	6	6	
B32					1.2	1.7	2.7	3.8	5.5	6	
B40						1.3	1.7	2.2	2.7	4.2	
C25				1.1	1.3	1.8	2.8	3.9	5.6	6	
C32					1.2	1.7	2.6	3.6	5.1	6	
C40						1.3	1.9	3.3	3.2	5.8	

Short-circuit selectivity **AFDD+** towards **Diazed¹⁾**

AFDD+	Diazed ²⁾									
	I _n [A]	16	20	25	32	35	50	63	80	100
B25					1.1	1.5	2.4	5.5	6	6
B32						1.4	2.1	4.3	6	6
B40							1.4	2.4	2.9	5.1
C25						1.1	1.5	2.3	4.4	6
C32							1.4	2.2	4.1	5.6
C40								1.6	2.8	3.6

Short-circuit selectivity **AFDD+** towards **NH00³⁾**

AFDD+	NH00 ³⁾												
	I _n [A]	16	20	25	32	35	40	50	63	80	100	125	160
B25					0.9	1.2	1.6	2.4	3.4	5.5	6	6	6
B32						1.1	1.4	2.1	2.9	4.3	6	6	6
B40							1.4	1.9	2.8	4.1	6	6	6
C25					0.9	1.2	1.6	2.3	3	4.6	6	6	6
C32						1.1	1.5	2.1	2.8	4.3	6	6	6
C40							1.5	2.1	3.1	5.4	6	6	6

Darker areas: no selectivity

¹⁾ SIEMENS Type 5SE2; Size: D01, D02, D03; Operating class gG; Rated voltage: AC 400 V/DC 250 V

²⁾ SIEMENS Type 5SB2, 5SB4, 5SC2; Size: DII, DIII, DIV; Operating class gG; Rated voltage: AC 500 V/DC 500 V

³⁾ SIEMENS Type 3NA3 8, 3NA6 8, 3NA7 8; Size: 000, 00; Operating class gG; Rated voltage: AC 500 V/DC 250 V

Let-through Energy AFDD+

Let-through Energy AFDD+, Characteristic B, 2-pole, 10-20 A

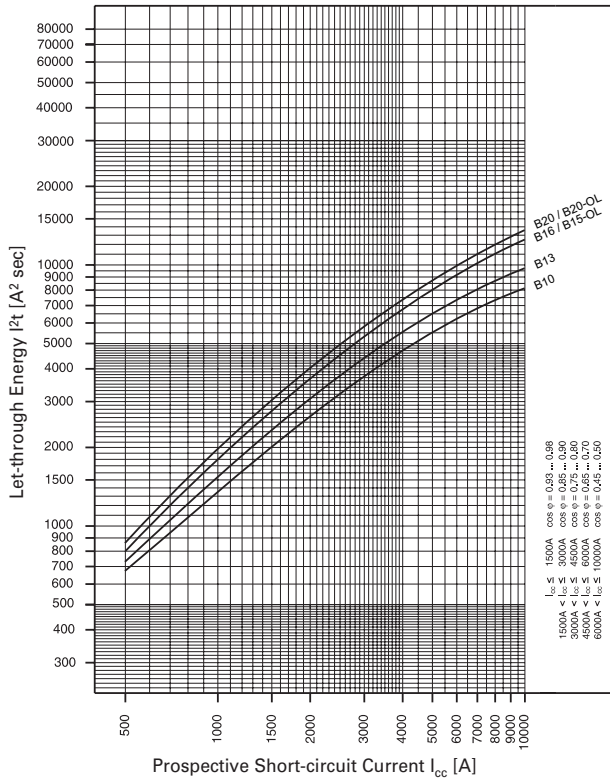

Let-through Energy AFDD+, Characteristic C, 2-pole, 6-20 A

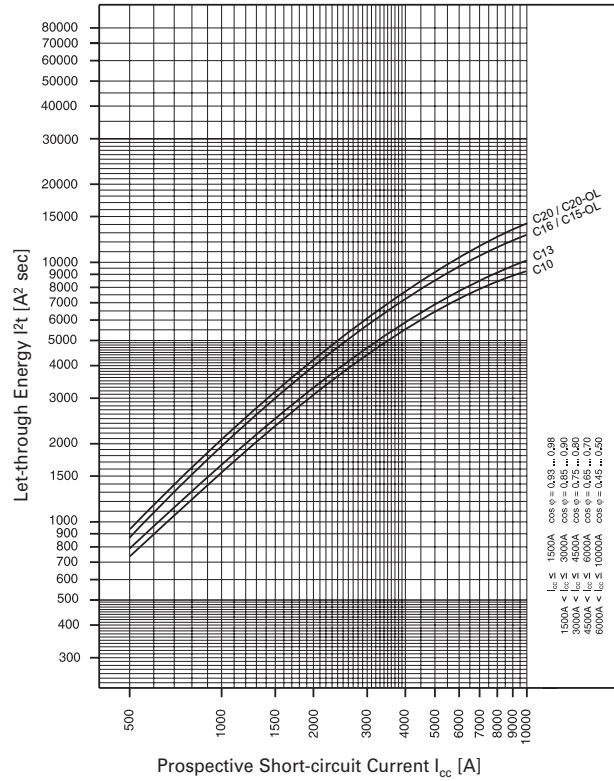

Let-through Energy AFDD+, Characteristic B, 2-pole, 25-40 A

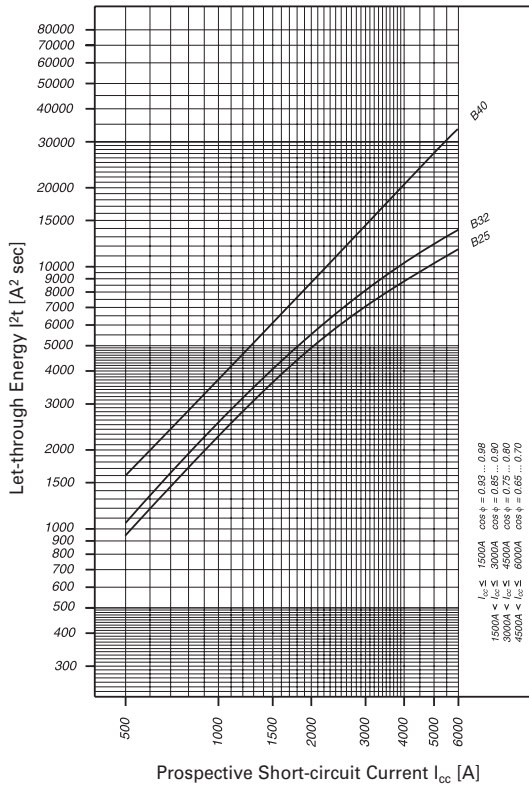

Let-through Energy AFDD+, Characteristic C, 2-pole, 25-40 A

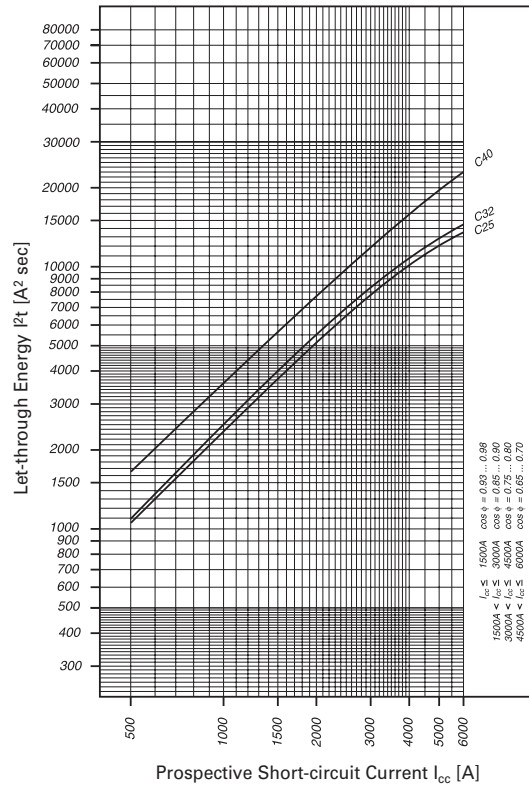

SG13711



Description

- High-quality residual current device / miniature circuit breaker combination, line voltage-independent
- Increased protection in applications with 1-phase frequency converter due to the detection of mixed frequencies (type F)
- Reduction of nuisance tripping (type F, G, or G/A) thanks to
 - time delayed tripping
 - increased current withstand capability > 3 kA
- Higher load rating with DC residual currents up to 10 mA (type F)
- Contact position indicator red - green
- Guide for secure terminal connection
- 3-position DIN rail clip, permits removal from existing busbar system
- Comprehensive range of accessories can be mounted subsequently
- Wide variety of rated tripping currents
- Rated currents up to 40 A
- Tripping characteristics B, C
- Rated breaking capacity 10 kA

1.4

Combined RCD/MCB Devices

xPole

Combined RCD/MCB Devices PKNM, 1+N-pole (MW)

$I_n/I_{\Delta n}$ (A)	Type Designation	Article No.	Units per package
---------------------------	---------------------	-------------	----------------------

Type F

10 kA, 1+N-pole

Short-time delayed + surge current-proof 3 kA, sensitive to residual pulsating DC and mixed frequencies, type F

SG13711



Characteristic B

13/003	PKNM-13/1N/B/003-F	193572	1/60
16/003	PKNM-16/1N/B/003-F	193573	1/60
20/003	PKNM-20/1N/B/003-F	193574	1/60
25/003	PKNM-25/1N/B/003-F	193581	1/60
32/003	PKNM-32/1N/B/003-F	193582	1/60
40/003	PKNM-40/1N/B/003-F	193583	1/60
13/03	PKNM-13/1N/B/03-F	193587	1/60
16/03	PKNM-16/1N/B/03-F	193588	1/60
20/03	PKNM-20/1N/B/03-F	193589	1/60
25/03	PKNM-25/1N/B/03-F	193596	1/60
32/03	PKNM-32/1N/B/03-F	193597	1/60
40/03	PKNM-40/1N/B/03-F	193598	1/60
13/01	PKNM-13/1N/B/01-F	193602	1/60
16/01	PKNM-16/1N/B/01-F	193603	1/60
20/01	PKNM-20/1N/B/01-F	193604	1/60
25/01	PKNM-25/1N/B/01-F	193611	1/60
32/01	PKNM-32/1N/B/01-F	193612	1/60
40/01	PKNM-40/1N/B/01-F	193613	1/60

SG13711



Characteristic C

13/003	PKNM-13/1N/C/003-F	193575	1/60
16/003	PKNM-16/1N/C/003-F	193576	1/60
20/003	PKNM-20/1N/C/003-F	193577	1/60
25/003	PKNM-25/1N/C/003-F	193584	1/60
32/003	PKNM-32/1N/C/003-F	193585	1/60
40/003	PKNM-40/1N/C/003-F	193586	1/60
13/03	PKNM-13/1N/C/03-F	193590	1/60
16/03	PKNM-16/1N/C/03-F	193591	1/60
20/03	PKNM-20/1N/C/03-F	193592	1/60
25/03	PKNM-25/1N/C/03-F	193599	1/60
32/03	PKNM-32/1N/C/03-F	193600	1/60
40/03	PKNM-40/1N/C/03-F	193601	1/60
13/01	PKNM-13/1N/C/01-F	193605	1/60
16/01	PKNM-16/1N/C/01-F	193606	1/60
20/01	PKNM-20/1N/C/01-F	193607	1/60
25/01	PKNM-25/1N/C/01-F	193614	1/60
32/01	PKNM-32/1N/C/01-F	193615	1/60
40/01	PKNM-40/1N/C/01-F	193616	1/60

SG13711



Characteristic D

13/003	PKNM-13/1N/D/003-F	193578	1/60
16/003	PKNM-16/1N/D/003-F	193579	1/60
20/003	PKNM-20/1N/D/003-F	193580	1/60
13/03	PKNM-13/1N/D/03-F	193593	1/60
16/03	PKNM-16/1N/D/03-F	193594	1/60
20/03	PKNM-20/1N/D/03-F	193595	1/60
13/01	PKNM-13/1N/D/01-F	193608	1/60
16/01	PKNM-16/1N/D/01-F	193609	1/60
20/01	PKNM-20/1N/D/01-F	193610	1/60

$I_n/I_{\Delta n}$ (A)	Type Designation	Article No.	Units per package
---------------------------	---------------------	-------------	----------------------

Type G/A

10 kA, 1+N-pole

Short-time delayed 3 kA, sensitive to residual pulsating DC, type G/A

Characteristic B

13/003	PKNM-13/1N/B/003-G/A	182886	1/60
16/003	PKNM-16/1N/B/003-G/A	182887	1/60
20/003	PKNM-20/1N/B/003-G/A	182888	1/60
25/003	PKNM-25/1N/B/003-G/A	182889	1/60
32/003	PKNM-32/1N/B/003-G/A	182890	1/60

SG13711



Characteristic C

13/003	PKNM-13/1N/C/003-G/A	182891	1/60
16/003	PKNM-16/1N/C/003-G/A	182892	1/60
20/003	PKNM-20/1N/C/003-G/A	182893	1/60
25/003	PKNM-25/1N/C/003-G/A	182894	1/60
32/003	PKNM-32/1N/C/003-G/A	182895	1/60

SG13711



1.4

Combined RCD/MCB Devices

xPole

Combined RCD/MCB Devices PKNM, 1+N-pole (MW)

$I_n/I_{\Delta n}$ (A)	Type Designation	Article No.	Units per package
---------------------------	---------------------	-------------	----------------------

Type A

10 kA, 1+N-pole

Conditionally surge current-proof 250 A, sensitive to residual pulsating DC, type A

SG13711



Characteristic B

6/0.03	PKNM-6/1N/B/003-A	236012	1/60
10/0.03	PKNM-10/1N/B/003-A	236072	1/60
13/0.03	PKNM-13/1N/B/003-A	236133	1/60
16/0.03	PKNM-16/1N/B/003-A	236205	1/60
20/0.03	PKNM-20/1N/B/003-A	236239	1/60
25/0.03	PKNM-25/1N/B/003-A	236269	1/60
32/0.03	PKNM-32/1N/B/003-A	236299	1/60
40/0.03	PKNM-40/1N/B/003-A	236328	1/60
6/0.3	PKNM-6/1N/B/03-A	236014	1/60
10/0.3	PKNM-10/1N/B/03-A	236074	1/60
13/0.3	PKNM-13/1N/B/03-A	236135	1/60
16/0.3	PKNM-16/1N/B/03-A	236207	1/60
20/0.3	PKNM-20/1N/B/03-A	236241	1/60
25/0.3	PKNM-25/1N/B/03-A	236271	1/60
32/0.3	PKNM-32/1N/B/03-A	236301	1/60
40/0.3	PKNM-40/1N/B/03-A	236330	1/60

SG13711



Characteristic C

6/0.03	PKNM-6/1N/C/003-A	236022	1/60
10/0.03	PKNM-10/1N/C/003-A	236082	1/60
13/0.03	PKNM-13/1N/C/003-A	236145	1/60
16/0.03	PKNM-16/1N/C/003-A	236217	1/60
20/0.03	PKNM-20/1N/C/003-A	236249	1/60
25/0.03	PKNM-25/1N/C/003-A	236279	1/60
32/0.03	PKNM-32/1N/C/003-A	236309	1/60
40/0.03	PKNM-40/1N/C/003-A	236338	1/60
6/0.3	PKNM-6/1N/C/03-A	236024	1/60
10/0.3	PKNM-10/1N/C/03-A	236084	1/60
13/0.3	PKNM-13/1N/C/03-A	236147	1/60
16/0.3	PKNM-16/1N/C/03-A	236219	1/60
20/0.3	PKNM-20/1N/C/03-A	236251	1/60
25/0.3	PKNM-25/1N/C/03-A	236281	1/60
32/0.3	PKNM-32/1N/C/03-A	236311	1/60
40/0.3	PKNM-40/1N/C/03-A	236340	1/60

$I_n/I_{\Delta n}$ (A)	Type Designation	Article No.	Units per package
---------------------------	---------------------	-------------	----------------------

Type AC

**10 kA, 1+N-pole
Conditionally surge current-proof 250 A, type AC**

SG13711



Characteristic B

6/0.03	PKNM-6/1N/B/003	236007	1/60
10/0.03	PKNM-10/1N/B/003	236067	1/60
13/0.03	PKNM-13/1N/B/003	236128	1/60
16/0.03	PKNM-16/1N/B/003	236200	1/60
20/0.03	PKNM-20/1N/B/003	236235	1/60
25/0.03	PKNM-25/1N/B/003	236265	1/60
32/0.03	PKNM-32/1N/B/003	236295	1/60
40/0.03	PKNM-40/1N/B/003	236324	1/60
6/0.3	PKNM-6/1N/B/03	236009	1/60
10/0.3	PKNM-10/1N/B/03	236069	1/60
13/0.3	PKNM-13/1N/B/03	236130	1/60
16/0.3	PKNM-16/1N/B/03	236202	1/60
20/0.3	PKNM-20/1N/B/03	236237	1/60
25/0.3	PKNM-25/1N/B/03	236267	1/60
32/0.3	PKNM-32/1N/B/03	236297	1/60
40/0.3	PKNM-40/1N/B/03	236326	1/60

SG13711



Characteristic C

6/0.03	PKNM-6/1N/C/003	236017	1/60
10/0.03	PKNM-10/1N/C/003	236077	1/60
13/0.03	PKNM-13/1N/C/003	236140	1/60
16/0.03	PKNM-16/1N/C/003	236212	1/60
20/0.03	PKNM-20/1N/C/003	236245	1/60
25/0.03	PKNM-25/1N/C/003	236275	1/60
32/0.03	PKNM-32/1N/C/003	236305	1/60
40/0.03	PKNM-40/1N/C/003	236334	1/60
16/0.1	PKNM-16/1N/C/01	236213	1/60
6/0.3	PKNM-6/1N/C/03	236019	1/60
10/0.3	PKNM-10/1N/C/03	236079	1/60
13/0.3	PKNM-13/1N/C/03	236142	1/60
16/0.3	PKNM-16/1N/C/03	236214	1/60
20/0.3	PKNM-20/1N/C/03	236247	1/60
25/0.3	PKNM-25/1N/C/03	236277	1/60
32/0.3	PKNM-32/1N/C/03	236307	1/60
40/0.3	PKNM-40/1N/C/03	236336	1/60

Specifications | Combined RCD/MCB Devices PKNM, 1+N-pole

Description

- Combined RCD/MCB Devices
- Line voltage-independent tripping
- Compatible with standard busbar
- Twin-purpose terminal (lift/open-mouthed) above and below
- Busbar positioning optionally above or below
- Free terminal space despite installed busbar
- Guide for secure terminal connection
- Switching toggle (MCB component) in colour designating the rated current
- Contact position indicator red - green
- Comprehensive range of accessories can be mounted subsequently
- The test key "T" must be pressed every 6 month. The system operator must be informed of this obligation and his responsibility in a way that can be proven (self-adhesive RCD-label enclosed). The test interval of 6 month is valid for residential and similar applications. Under all other conditions (e.g. damply or dusty environments), it's recommended to test in shorter intervals (e.g. monthly).
- Pressing the test key "T" serves the only purpose of function testing the residual current device (RCD). This test does not make earthing resistance measurement (R_E), or proper checking of the earth conductor condition redundant, which must be performed separately.
- **Type -A:** Protects against special forms of residual pulsating DC which have not been smoothed.
- **Type -G:** 10 ms time delay in order to avoid unwanted tripping (e.g. during thunderstorms). Suitable for any circuit where personal injury or damage to property may occur in case of unwanted tripping.
- **Type -F:** Increased protection in applications with 1-phase frequency converter due to the detection of mixed frequencies, higher load capacity with smooth DC fault currents up to 10 mA.

Accessories:

Auxiliary switch for subsequent installation	ZP-IHK	286052
	ZP-WHK	286053
Tripping signal switch for subsequent installation	ZP-NHK	248437
Shunt trip release	ZP-ASA/..	248438, 248439
Additional terminal 35 mm ²	BB-UL-TEPA/35	169823

Technical Data

		PKNM, 1+N-pole
Electrical		
Design according to		IEC/EN 61009
Current test marks as printed onto the device		
Line voltage-independent tripping	Type AC, A Type G, F	instantaneous 250 A (8/20 μs), surge current proof 10 ms delay 3 kA (8/20 μs), surge current proof
Rated voltage	U_e	230 V AC, 50 Hz
Operational voltage range		196-253 V
Rated tripping current	$I_{\Delta n}$	10, 30, 100, 300 mA
Rated non-tripping current	$I_{\Delta no}$	0.5 $I_{\Delta n}$
Rated insulation voltage	U_i	440 VAC
Sensitivity		AC and pulsating DC
Selectivity class		3
Rated breaking capacity	I_{cn}	10 kA
Rated current		2 - 40 A
Rated impulse withstand voltage	U_{imp}	4 kV (1.2/50 μs)
Characteristic		B, C
Maximum back-up fuse (short-circuit)		100 A gL (>10 kA)
Endurance		
electrical components		≥ 4,000 switching operations
mechanical components		≥ 20,000 switching operations
Mechanical		
Frame size		45 mm
Device height		80 mm
Device width		35 mm (2 MU)
Mounting		3-position DIN rail clip, permits removal from existing busbar system
Degree of protection, switch		IP20
Degree of protection, built-in		IP40
Upper and lower terminals		open-mouthed/lift terminals
Terminal protection		finger and hand touch safe, DGUV VS3, EN 50274
Terminal capacity		1 - 25 mm ²
Terminal torque		2 - 2.4 Nm
Busbar thickness		0.8 - 2 mm
Operating temperature		-25°C to +55°C
Storage- and transport temperature		-35°C to +60°C
Resistance to climatic conditions		according to IEC/EN 61009

Connection diagram

1+N-pole

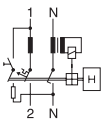

Dimensions (mm)

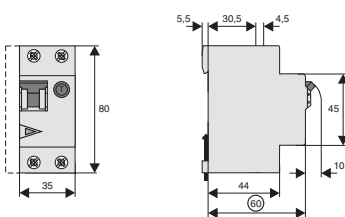

Load Capacity PKNM-../1N/

Effect of ambient temperature (MCB component)

I _n [A]	Ambient temperature T [°C]							
	-25	-15	-5	10	30	40	45	55
6	7	6.8	6.6	6.4	6	5.7	5.6	5.3
10	12.3	11.9	11.4	10.8	10	9.5	9.3	8.8
13	15.1	14.7	14.3	13.7	13	12.5	12.3	11.8
16	19.1	18.6	18	17.1	16	15.2	14.9	14.1
20	24.8	23.9	23	21.7	20	19	18.5	17.5
25	31.4	30.2	29.1	27.3	25	23.9	23.3	22.1
32	40.1	38.6	37.1	34.9	32	30.4	29.6	28
40	51	49	47	44	40	38.1	37.1	35.1

Tripping Characteristic PKNM-../1N/, Characteristics B and C

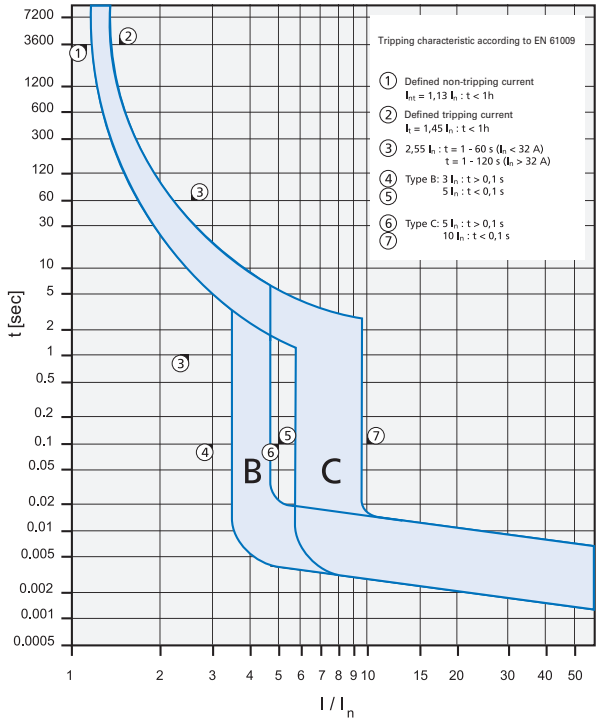

Short-circuit Selectivity PKNM-../1N/ towards DII-DIV fuse link

In case of short-circuit, there is selectivity between the combined RCD/MCB devices PKNM-../1N/ and the upstream fuses up to the specified values of the selectivity limit current I_s [kA] (i. e. in case of short-circuit currents I_{ks} under I_s, only the MCB will trip, in case of short-circuit currents above this value both protective devices will respond).

*) basically in accordance with EN 60898-1 D.5.2.b

Short-circuit selectivity **Characteristic B** towards fuse link **DII-DIV***

PKNM I _n [A]	DII-DIV gL/gG								
	10	16	20	25	35	50	63	80	100
2	<0.5 ¹⁾	<0.5 ¹⁾	2.2	8.5	10.0 ²⁾	10.0 ²⁾	10.0 ²⁾	10.0 ²⁾	10.0 ²⁾
4	<0.5 ¹⁾	<0.5 ¹⁾	0.7	1.2	3.7	10.0	10.0 ²⁾	10.0 ²⁾	10.0 ²⁾
6		<0.5 ¹⁾	0.7	1.0	2.9	6.9	10.0 ²⁾	10.0 ²⁾	10.0 ²⁾
8		<0.5 ¹⁾	0.6	1.0	2.4	5.1	10.0 ²⁾	10.0 ²⁾	10.0 ²⁾
10			0.6	0.9	1.9	3.3	7.0	10.0 ²⁾	10.0 ²⁾
13			0.5	0.7	1.6	2.8	5.7	9.0	10.0 ²⁾
16				0.7	1.4	2.4	4.4	7.0	10.0 ²⁾
20					1.3	2.2	4.0	6.3	10.0 ²⁾
25						1.3	2.1	3.8	5.8
32							2.0	3.5	5.2
40								3.1	4.5

Short-circuit selectivity **Characteristic C** towards fuse link **DII-DIV***

PKNM I _n [A]	DII-DIV gL/gG								
	10	16	20	25	35	50	63	80	100
2	<0.5 ¹⁾	<0.5 ¹⁾	1.7	6.0	10.0 ²⁾	10.0 ²⁾	10.0 ²⁾	10.0 ²⁾	10.0 ²⁾
4	<0.5 ¹⁾	<0.5 ¹⁾	0.7	1.3	4.2	8.5	10.0 ²⁾	10.0 ²⁾	10.0 ²⁾
5	<0.5 ¹⁾	<0.5 ¹⁾	0.6	1.1	3.6	7.0	10.0 ²⁾	10.0 ²⁾	10.0 ²⁾
6		<0.5 ¹⁾	0.6	1.0	2.9	5.8	10.0 ²⁾	10.0 ²⁾	10.0 ²⁾
8		<0.5 ¹⁾	<0.5	0.9	2.5	4.8	10.0 ²⁾	10.0 ²⁾	10.0 ²⁾
10			<0.5	0.7	1.5	2.6	5.3	9.0	10.0 ²⁾
13					1.4	2.3	4.6	7.6	10.0 ²⁾
16					1.2	1.8	3.4	5.5	10.0 ²⁾
20					1.2	1.7	3.1	5.0	10.0 ²⁾
25						1.6	2.9	4.6	10.0 ²⁾
32							2.3	3.4	7.7
40								2.9	6.2

¹⁾ Selectivity limit current I_s under 0.5 kA.

²⁾ Selectivity limit current I_s = rated breaking capacity I_{cn} of the RCD/MCB device
Darker areas: no selectivity



Short-circuit Selectivity PKNM-./1N/ towards D01-D03 fuse link

In case of short-circuit, there is selectivity between the combined RCD/MCB devices PKNM-./1N/ and the upstream fuses up to the specified values of the selectivity limit current I_s [kA] (i. e. in case of short-circuit currents I_{ks} under I_s , only the MCB will trip, in case of short-circuit currents above this value both protective devices will respond).

*) basically in accordance with EN 60898-1 D.5.2.b

Short-circuit selectivity **Characteristic B** towards fuse link **D01-D03***

PKNM	D01-D03 gL/gG									
	I_n [A]	10	16	20	25	35	50	63	80	100
2	<0.5 ¹⁾	0.7	1.6	3.3	10.0 ²⁾	10.0 ²⁾	10.0 ²⁾	10.0 ²⁾	10.0 ²⁾	10.0 ²⁾
4	<0.5 ¹⁾	<0.5 ¹⁾	0.6	0.9	2.9	10.0	10.0 ²⁾	10.0 ²⁾	10.0 ²⁾	10.0 ²⁾
6		<0.5 ¹⁾	0.5	0.8	2.4	8.2	10.0 ²⁾	10.0 ²⁾	10.0 ²⁾	10.0 ²⁾
8			0.6	0.8	2.0	6.0	10.0 ²⁾	10.0 ²⁾	10.0 ²⁾	10.0 ²⁾
10			0.5	0.8	1.6	3.7	6.0	10.0 ²⁾	10.0 ²⁾	10.0 ²⁾
13			0.6	0.7	1.4	3.0	4.7	9.0	10.0 ²⁾	10.0 ²⁾
16				0.6	1.2	2.6	3.9	7.0	10.0 ²⁾	10.0 ²⁾
20					1.2	2.5	3.6	6.2	10.0 ²⁾	10.0 ²⁾
25					1.2	2.3	3.3	5.7	10.0 ²⁾	10.0 ²⁾
32						2.3	3.1	5.1	10.0 ²⁾	10.0 ²⁾
40							2.8	4.5	9.5	10.0 ²⁾

Short-circuit selectivity **Characteristic C** towards fuse link **D01-D03***

PKNM	D01-D03 gL/gG									
	I_n [A]	10	16	20	25	35	50	63	80	100
2	<0.5 ¹⁾	0.5	0.5	2.4	10.0 ²⁾	10.0 ²⁾	10.0 ²⁾	10.0 ²⁾	10.0 ²⁾	10.0 ²⁾
4	<0.5 ¹⁾	<0.5 ¹⁾	<0.5 ¹⁾	0.9	3.4	9.5	10.0 ²⁾	10.0 ²⁾	10.0 ²⁾	10.0 ²⁾
5	<0.5 ¹⁾	<0.5 ¹⁾	<0.5 ¹⁾	0.9	2.9	8.0	10.0 ²⁾	10.0 ²⁾	10.0 ²⁾	10.0 ²⁾
6		<0.5 ¹⁾	<0.5 ¹⁾	0.8	2.3	6.5	10.0 ²⁾	10.0 ²⁾	10.0 ²⁾	10.0 ²⁾
8			<0.5	0.7	2.1	5.5	9.5	10.0 ²⁾	10.0 ²⁾	10.0 ²⁾
10			<0.5	0.6	1.3	2.9	4.5	8.9	10.0 ²⁾	10.0 ²⁾
13					1.2	2.5	3.9	7.6	10.0 ²⁾	10.0 ²⁾
16					1.0	2.1	3.0	5.5	10.0 ²⁾	10.0 ²⁾
20					1.0	2.0	2.7	5.0	10.0 ²⁾	10.0 ²⁾
25						1.9	2.6	4.5	10.0 ²⁾	10.0 ²⁾
32							2.1	3.4	10.0 ²⁾	10.0 ²⁾
40								3.0	8.7	10.0 ²⁾

Short-circuit Selectivity PKNM-./1N/ towards NH-00 fuse link

In case of short-circuit, there is selectivity between the combined RCD/MCB devices PKNM-./1N/ and the upstream fuses up to the specified values of the selectivity limit current I_s [kA] (i. e. in case of short-circuit currents I_{ks} under I_s , only the MCB will trip, in case of short-circuit currents above this value both protective devices will respond).

*) basically in accordance with EN 60898-1 D.5.2.b

Short-circuit selectivity **Characteristic B** towards fuse link **NH-00***

PKNM	D01-D03 gL/gG												
	I_n [A]	16	20	25	32	35	40	50	63	80	100	125	160
2	<0.5 ¹⁾	1.1	3.6	10.0 ²⁾	10.0 ²⁾	10.0 ²⁾	10.0 ²⁾	10.0 ²⁾	10.0 ²⁾	10.0 ²⁾	10.0 ²⁾	10.0 ²⁾	10.0 ²⁾
4	<0.5 ¹⁾	0.5	0.9	1.6	2.8	4.4	10.0 ²⁾	10.0 ²⁾	10.0 ²⁾	10.0 ²⁾	10.0 ²⁾	10.0 ²⁾	10.0 ²⁾
6	<0.5 ¹⁾	0.5	0.8	1.4	2.2	3.3	7.0	10.0 ²⁾	10.0 ²⁾	10.0 ²⁾	10.0 ²⁾	10.0 ²⁾	10.0 ²⁾
8	<0.5 ¹⁾	<0.5 ¹⁾	0.7	1.0	1.9	2.8	5.3	7.8	10.0 ²⁾	10.0 ²⁾	10.0 ²⁾	10.0 ²⁾	10.0 ²⁾
10		<0.5 ¹⁾	0.7	0.9	1.5	2.1	3.4	4.3	7.3	10.0 ²⁾	10.0 ²⁾	10.0 ²⁾	10.0 ²⁾
13		<0.5 ¹⁾	0.6	0.8	1.4	1.8	2.8	3.6	5.7	10.0 ²⁾	10.0 ²⁾	10.0 ²⁾	10.0 ²⁾
16			0.6	0.7	1.2	1.5	2.4	3.0	4.5	10.0 ²⁾	10.0 ²⁾	10.0 ²⁾	10.0 ²⁾
20				0.7	1.1	1.5	2.2	2.8	4.2	9.2	10.0 ²⁾	10.0 ²⁾	10.0 ²⁾
25					0.7	1.1	1.4	2.1	2.6	4.0	8.2	10.0 ²⁾	10.0 ²⁾
32						1.0	1.4	2.0	2.5	3.7	7.1	10.0 ²⁾	10.0 ²⁾
40								2.3	3.4	6.2	8.8	10.0 ²⁾	10.0 ²⁾

Short-circuit selectivity **Characteristic C** towards fuse link **NH-00***

PKNM	D01-D03 gL/gG												
	I_n [A]	16	20	25	32	35	40	50	63	80	100	125	160
2	<0.5 ¹⁾	0.6	2.6	10.0 ²⁾	10.0 ²⁾	10.0 ²⁾	10.0 ²⁾	10.0 ²⁾	10.0 ²⁾	10.0 ²⁾	10.0 ²⁾	10.0 ²⁾	10.0 ²⁾
4	<0.5 ¹⁾	<0.5 ¹⁾	0.9	1.8	3.2	4.8	8.7	10.0 ²⁾	10.0 ²⁾	10.0 ²⁾	10.0 ²⁾	10.0 ²⁾	10.0 ²⁾
5	<0.5 ¹⁾	<0.5 ¹⁾	0.8	1.6	2.7	4.1	7.2	9.7	10.0 ²⁾	10.0 ²⁾	10.0 ²⁾	10.0 ²⁾	10.0 ²⁾
6	<0.5 ¹⁾	<0.5 ¹⁾	0.7	1.3	2.2	3.3	5.9	8.0	10.0 ²⁾	10.0 ²⁾	10.0 ²⁾	10.0 ²⁾	10.0 ²⁾
8	<0.5 ¹⁾	<0.5 ¹⁾	0.6	1.1	1.9	2.8	5.0	6.7	10.0 ²⁾	10.0 ²⁾	10.0 ²⁾	10.0 ²⁾	10.0 ²⁾
10			0.5	0.8	1.2	1.7	2.7	3.4	5.5	10.0 ²⁾	10.0 ²⁾	10.0 ²⁾	10.0 ²⁾
13					1.1	1.5	2.3	2.9	4.7	10.0 ²⁾	10.0 ²⁾	10.0 ²⁾	10.0 ²⁾
16					1.0	1.3	1.8	2.3	3.7	8.7	10.0 ²⁾	10.0 ²⁾	10.0 ²⁾
20						0.9	1.1	1.7	2.2	3.4	8.0	10.0 ²⁾	10.0 ²⁾
25							1.6	2.1	3.2	7.2	10.0 ²⁾	10.0 ²⁾	10.0 ²⁾
32								1.7	2.6	5.3	9.0	10.0 ²⁾	10.0 ²⁾
40									2.4	4.5	7.5	10.0	10.0

¹⁾ Selectivity limit current I_s under 0.5 kA.

²⁾ Selectivity limit current I_s = rated breaking capacity I_{cn} of the RCD/MCB device

Darker areas: no selectivity



Let-through Energy PKNM-../1N/

Let-through Energy PKNM, Characteristic B, 1+N-pole

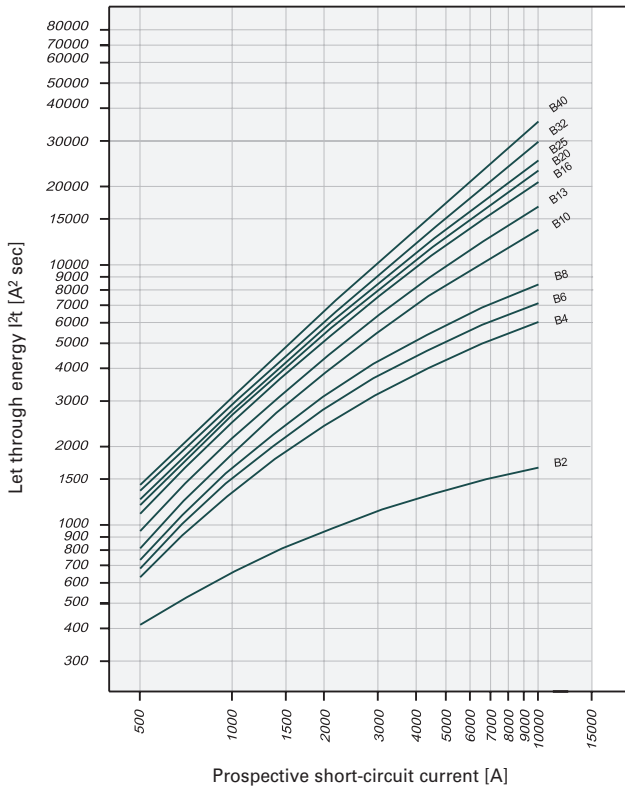

Let-through Energy PKNM, Characteristic C, 1+N-pole

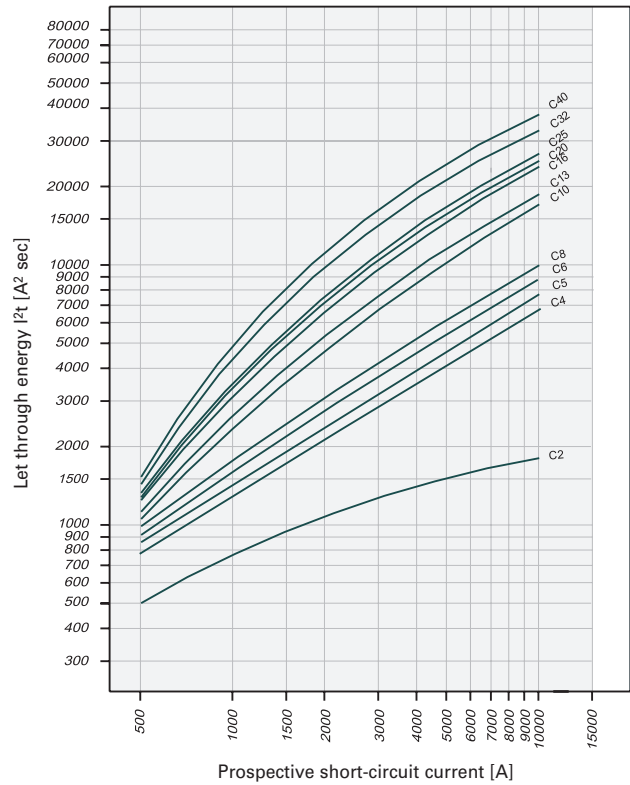

SG14111



Description

- High-quality residual current device / miniature circuit breaker combination, line voltage-independent
- Contact position indicator red - green
- Guide for secure terminal connection
- 3-position DIN rail clip, permits removal from existing busbar system
- Comprehensive range of accessories can be mounted subsequently
- Wide variety of rated tripping currents
- Rated currents up to 40 A
- Tripping characteristics B, C
- Rated breaking capacity 6 kA

$I_n/I_{\Delta n}$ (A)	Type Designation	Article No.	Units per package
---------------------------	---------------------	-------------	----------------------

Type A

6 kA, 1+N-pole

Conditionally surge current-proof 250 A, sensitive to residual pulsating DC, type A

SG14111



Characteristic B

6/0.03	PKN6-6/1N/B/003-A	236440	1/60
10/0.03	PKN6-10/1N/B/003-A	236500	1/60
13/0.03	PKN6-13/1N/B/003-A	236561	1/60
16/0.03	PKN6-16/1N/B/003-A	236633	1/60
20/0.03	PKN6-20/1N/B/003-A	236667	1/60
25/0.03	PKN6-25/1N/B/003-A	236697	1/60
32/0.03	PKN6-32/1N/B/003-A	236727	1/60
40/0.03	PKN6-40/1N/B/003-A	236756	1/60
6/0.3	PKN6-6/1N/B/03-A	236442	1/60
10/0.3	PKN6-10/1N/B/03-A	236502	1/60
13/0.3	PKN6-13/1N/B/03-A	236563	1/60
16/0.3	PKN6-16/1N/B/03-A	236635	1/60
20/0.3	PKN6-20/1N/B/03-A	236669	1/60
25/0.3	PKN6-25/1N/B/03-A	236699	1/60
32/0.3	PKN6-32/1N/B/03-A	236729	1/60
40/0.3	PKN6-40/1N/B/03-A	236758	1/60

SG14111



Characteristic C

6/0.03	PKN6-6/1N/C/003-A	236450	1/60
10/0.03	PKN6-10/1N/C/003-A	236510	1/60
13/0.03	PKN6-13/1N/C/003-A	236573	1/60
16/0.03	PKN6-16/1N/C/003-A	236645	1/60
20/0.03	PKN6-20/1N/C/003-A	236677	1/60
25/0.03	PKN6-25/1N/C/003-A	236707	1/60
32/0.03	PKN6-32/1N/C/003-A	236737	1/60
40/0.03	PKN6-40/1N/C/003-A	236766	1/60
6/0.3	PKN6-6/1N/C/03-A	236452	1/60
10/0.3	PKN6-10/1N/C/03-A	236512	1/60
13/0.3	PKN6-13/1N/C/03-A	236575	1/60
16/0.3	PKN6-16/1N/C/03-A	236647	1/60
20/0.3	PKN6-20/1N/C/03-A	236679	1/60
25/0.3	PKN6-25/1N/C/03-A	236709	1/60
32/0.3	PKN6-32/1N/C/03-A	236739	1/60
40/0.3	PKN6-40/1N/C/03-A	236768	1/60

$I_n/I_{\Delta n}$ (A)	Type Designation	Article No.	Units per package
---------------------------	---------------------	-------------	----------------------

Type AC

**6 kA, 1+N-pole
 Conditionally surge current-proof 250 A, type AC**

SG14111



Characteristic B

6/0.03	PKN6-6/1N/B/003	236435	1/60
10/0.03	PKN6-10/1N/B/003	236495	1/60
13/0.03	PKN6-13/1N/B/003	236556	1/60
16/0.03	PKN6-16/1N/B/003	236628	1/60
20/0.03	PKN6-20/1N/B/003	236663	1/60
25/0.03	PKN6-25/1N/B/003	236693	1/60
32/0.03	PKN6-32/1N/B/003	236723	1/60
40/0.03	PKN6-40/1N/B/003	236752	1/60
6/0.3	PKN6-6/1N/B/03	236437	1/60
10/0.3	PKN6-10/1N/B/03	236497	1/60
13/0.3	PKN6-13/1N/B/03	236558	1/60
16/0.3	PKN6-16/1N/B/03	236630	1/60
20/0.3	PKN6-20/1N/B/03	236665	1/60
25/0.3	PKN6-25/1N/B/03	236695	1/60
32/0.3	PKN6-32/1N/B/03	236725	1/60
40/0.3	PKN6-40/1N/B/03	236754	1/60

SG14111



Characteristic C

6/0.03	PKN6-6/1N/C/003	236445	1/60
10/0.03	PKN6-10/1N/C/003	236505	1/60
13/0.03	PKN6-13/1N/C/003	236568	1/60
16/0.03	PKN6-16/1N/C/003	236640	1/60
20/0.03	PKN6-20/1N/C/003	236673	1/60
25/0.03	PKN6-25/1N/C/003	236703	1/60
32/0.03	PKN6-32/1N/C/003	236733	1/60
40/0.03	PKN6-40/1N/C/003	236762	1/60
6/0.3	PKN6-6/1N/C/03	236447	1/60
10/0.3	PKN6-10/1N/C/03	236507	1/60
13/0.3	PKN6-13/1N/C/03	236570	1/60
16/0.3	PKN6-16/1N/C/03	236642	1/60
20/0.3	PKN6-20/1N/C/03	236675	1/60
25/0.3	PKN6-25/1N/C/03	236705	1/60
32/0.3	PKN6-32/1N/C/03	236735	1/60
40/0.3	PKN6-40/1N/C/03	236764	1/60

Specifications | Combined RCD/MCB Devices PKN6, 1+N-pole

Description

- Combined RCD/MCB Devices
- Line voltage-independent tripping
- Compatible with standard busbar
- Twin-purpose terminal (lift/open-mouthed) above and below
- Busbar positioning optionally above or below
- Free terminal space despite installed busbar
- Guide for secure terminal connection
- Switching toggle (MCB component) in colour designating the rated current
- Contact position indicator red - green
- Comprehensive range of accessories can be mounted subsequently
- The test key "T" must be pressed every 6 month. The system operator must be informed of this obligation and his responsibility in a way that can be proven (self-adhesive RCD-label enclosed). The test intervall of 6 month is valid for residential and similar applications. Under all other conditions (e.g. damply or dusty environments), it's recommended to test in shorter intervalls (e.g. monthly).
- Pressing the test key "T" serves the only purpose of function testing the residual current device (RCD). This test does not make earthing resistance measurement (R_E), or proper checking of the earth conductor condition redundant, which must be performed separately.
- **Type -A:** Protects against special forms of residual pulsating DC which have not been smoothed.
- **Type -G:** 10 ms time delay in order to avoid unwanted tripping (e.g. during thunderstorms). Suitable for any circuit where personal injury or damage to property may occur in case of unwanted tripping.

Accessories:

Auxiliary switch for subsequent installation	ZP-IHK	286052
	ZP-WHK	286053
Tripping signal switch for subsequent installation	ZP-NHK	248437
Shunt trip release	ZP-ASA/..	248438, 248439
Additional terminal 35 mm ²	BB-UL-TEPA/35	169823

Technical Data

		PKN6, 1+N-pole
Electrical		
Design according to		IEC/EN 61009
Current test marks as printed onto the device		
Line voltage-independent tripping		instantaneous 250 A (8/20 μs), surge current proof
Type G		10 ms delay 3 kA (8/20 μs), surge current proof
Rated voltage	U_e	230 V AC; 50 Hz
Operational voltage range		196-253 V
Rated tripping current	$I_{\Delta n}$	10, 30, 100, 300 mA
Rated non-tripping current	$I_{\Delta no}$	0.5 $I_{\Delta n}$
Rated insulation voltage	U_i	440 VAC
Sensitivity		AC and pulsating DC
Selectivity class		3
Rated breaking capacity	I_{cn}	6 kA
Rated current		2 - 40 A
Rated impulse withstand voltage	U_{imp}	4 kV (1.2/50 μs)
Characteristic		B, C
Maximum back-up fuse (short-circuit)		100 A gL (>6 kA)
Endurance		
electrical components		≥ 4,000 switching operations
mechanical components		≥ 20,000 switching operations
Mechanical		
Frame size		45 mm
Device height		80 mm
Device width		35 mm (2 MU)
Mounting		3-position DIN rail clip, permits removal from existing busbar system
Degree of protection, switch		IP20
Degree of protection, built-in		IP40
Upper and lower terminals		open-mouthed/lift terminals
Terminal protection		finger and hand touch safe, DGUV VS3, EN 50274
Terminal capacity		1 - 25 mm ²
Terminal torque		2 - 2.4 Nm
Busbar thickness		0.8 - 2 mm
Operating temperature		-25°C to +55°C
Storage- and transport temperature		-35°C to +60°C
Resistance to climatic conditions		according to IEC/EN 61009

Connection diagram

1+N-pole

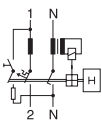

Dimensions (mm)

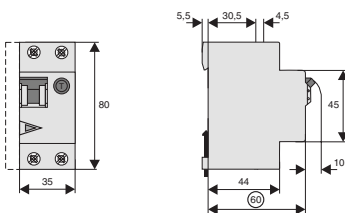

Load Capacity PKN6-../1N/

Effect of ambient temperature (MCB component)

I _n [A]	Ambient temperature T [°C]							
	-25	-15	-5	10	30	40	45	55
6	7	6.8	6.6	6.4	6	5.7	5.6	5.3
10	12.3	11.9	11.4	10.8	10	9.5	9.3	8.8
13	15.1	14.7	14.3	13.7	13	12.5	12.3	11.8
16	19.1	18.6	18	17.1	16	15.2	14.9	14.1
20	24.8	23.9	23	21.7	20	19	18.5	17.5
25	31.4	30.2	29.1	27.3	25	23.9	23.3	22.1
32	40.1	38.6	37.1	34.9	32	30.4	29.6	28
40	51	49	47	44	40	38.1	37.1	35.1

Tripping Characteristic PKN6-../1N/, Characteristics B and C

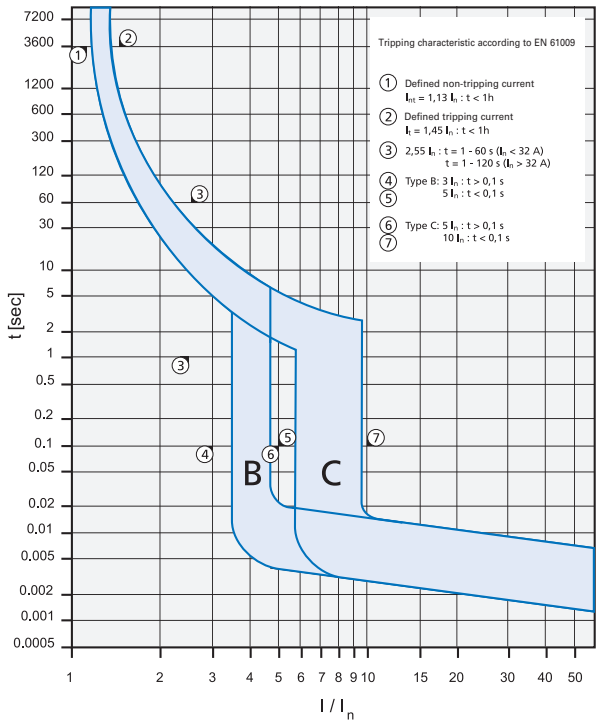

Short-circuit Selectivity PKN6-../1N/ towards DII-DIV fuse link

In case of short-circuit, there is selectivity between the combined RCD/MCB devices PKN6-../1N/ and the upstream fuses up to the specified values of the selectivity limit current I_s [kA] (i. e. in case of short-circuit currents I_{ks} under I_s, only the MCB will trip, in case of short-circuit currents above this value both protective devices will respond).

*) basically in accordance with EN 60898-1 D.5.2.b

Short-circuit selectivity **Characteristic B** towards fuse link **DII-DIV***

PKN6 I _n [A]	DII-DIV gL/gG								
	10	16	20	25	35	50	63	80	100
2	<0.5 ¹⁾	<0.5 ¹⁾	2.2	6.0 ²⁾	6.0 ²⁾	6.0 ²⁾	6.0 ²⁾	6.0 ²⁾	6.0 ²⁾
4	<0.5 ¹⁾	<0.5 ¹⁾	0.7	1.2	3.7	6.0 ²⁾	6.0 ²⁾	6.0 ²⁾	6.0 ²⁾
6		<0.5 ¹⁾	0.7	1.0	2.9	6.0 ²⁾	6.0 ²⁾	6.0 ²⁾	6.0 ²⁾
8		<0.5 ¹⁾	0.6	1.0	2.4	5.1	6.0 ²⁾	6.0 ²⁾	6.0 ²⁾
10			0.6	0.9	1.9	3.3	6.0 ²⁾	6.0 ²⁾	6.0 ²⁾
13			0.5	0.7	1.6	2.8	5.7	6.0 ²⁾	6.0 ²⁾
16				0.7	1.4	2.4	4.4	6.0 ²⁾	6.0 ²⁾
20					1.3	2.2	4.0	6.0 ²⁾	6.0 ²⁾
25					1.3	2.1	3.8	5.8	6.0 ²⁾
32						2.0	3.5	5.2	6.0 ²⁾
40							3.1	4.5	6.0 ²⁾

Short-circuit selectivity **Characteristic C** towards fuse link **DII-DIV***

PKN6 I _n [A]	DII-DIV gL/gG								
	10	16	20	25	35	50	63	80	100
2	<0.5 ¹⁾	<0.5 ¹⁾	1.7	6.0 ²⁾	6.0 ²⁾	6.0 ²⁾	6.0 ²⁾	6.0 ²⁾	6.0 ²⁾
4	<0.5 ¹⁾	<0.5 ¹⁾	0.7	1.3	4.2	6.0 ²⁾	6.0 ²⁾	6.0 ²⁾	6.0 ²⁾
5	<0.5 ¹⁾	<0.5 ¹⁾	0.6	1.1	3.6	6.0 ²⁾	6.0 ²⁾	6.0 ²⁾	6.0 ²⁾
6		<0.5 ¹⁾	0.6	1.0	2.9	5.8	6.0 ²⁾	6.0 ²⁾	6.0 ²⁾
8		<0.5 ¹⁾	<0.5	0.9	2.5	4.8	6.0 ²⁾	6.0 ²⁾	6.0 ²⁾
10			<0.5	0.7	1.5	2.6	5.3	6.0 ²⁾	6.0 ²⁾
13					1.4	2.3	4.6	6.0 ²⁾	6.0 ²⁾
16					1.2	1.8	3.4	5.5	6.0 ²⁾
20					1.2	1.7	3.1	5.0	6.0 ²⁾
25						1.6	2.9	4.6	6.0 ²⁾
32							2.3	3.4	6.0 ²⁾
40								2.9	6.0 ²⁾

¹⁾ Selectivity limit current I_s under 0.5 kA.

²⁾ Selectivity limit current I_s = rated breaking capacity I_{cn} of the RCD/MCB device

Darker areas: no selectivity



Short-circuit Selectivity PKN6-./1N/ towards D01-D03 fuse link

In case of short-circuit, there is selectivity between the combined RCD/MCB devices PKN6-./1N/ and the upstream fuses up to the specified values of the selectivity limit current I_s [kA] (i. e. in case of short-circuit currents I_{ks} under I_s , only the MCB will trip, in case of short-circuit currents above this value both protective devices will respond).

*) basically in accordance with EN 60898-1 D.5.2.b

Short-circuit selectivity **Characteristic B** towards fuse link **D01-D03***

PKN6	D01-D03 gL/gG									
	I_n [A]	10	16	20	25	35	50	63	80	100
2	<0.5 ¹⁾	0.7	1.6	3.3	6.0 ²⁾	6.0 ²⁾	6.0 ²⁾	6.0 ²⁾	6.0 ²⁾	6.0 ²⁾
4	<0.5 ¹⁾	<0.5 ¹⁾	0.6	0.9	2.9	6.0 ²⁾	6.0 ²⁾	6.0 ²⁾	6.0 ²⁾	6.0 ²⁾
6		<0.5 ¹⁾	0.5	0.8	2.4	6.0 ²⁾	6.0 ²⁾	6.0 ²⁾	6.0 ²⁾	6.0 ²⁾
8			0.6	0.8	2.0	6.0 ²⁾	6.0 ²⁾	6.0 ²⁾	6.0 ²⁾	6.0 ²⁾
10			0.5	0.8	1.6	3.7	6.0 ²⁾	6.0 ²⁾	6.0 ²⁾	6.0 ²⁾
13			0.6	0.7	1.4	3.0	4.7	6.0 ²⁾	6.0 ²⁾	6.0 ²⁾
16				0.6	1.2	2.6	3.9	6.0 ²⁾	6.0 ²⁾	6.0 ²⁾
20					1.2	2.5	3.6	6.0 ²⁾	6.0 ²⁾	6.0 ²⁾
25					1.2	2.3	3.3	5.7	6.0 ²⁾	6.0 ²⁾
32						2.3	3.1	5.1	6.0 ²⁾	6.0 ²⁾
40							2.8	4.5	6.0 ²⁾	6.0 ²⁾

Short-circuit selectivity **Characteristic C** towards fuse link **D01-D03***

PKN6	D01-D03 gL/gG									
	I_n [A]	10	16	20	25	35	50	63	80	100
2	<0.5 ¹⁾	0.5	0.5	2.4	6.0 ²⁾	6.0 ²⁾	6.0 ²⁾	6.0 ²⁾	6.0 ²⁾	6.0 ²⁾
4	<0.5 ¹⁾	<0.5 ¹⁾	<0.5 ¹⁾	0.9	3.4	6.0 ²⁾	6.0 ²⁾	6.0 ²⁾	6.0 ²⁾	6.0 ²⁾
5	<0.5 ¹⁾	<0.5 ¹⁾	<0.5 ¹⁾	0.9	2.9	6.0 ²⁾	6.0 ²⁾	6.0 ²⁾	6.0 ²⁾	6.0 ²⁾
6		<0.5 ¹⁾	<0.5 ¹⁾	0.8	2.3	6.0 ²⁾	6.0 ²⁾	6.0 ²⁾	6.0 ²⁾	6.0 ²⁾
8			<0.5	0.7	2.1	5.5	6.0 ²⁾	6.0 ²⁾	6.0 ²⁾	6.0 ²⁾
10			<0.5	0.6	1.3	2.9	4.5	6.0 ²⁾	6.0 ²⁾	6.0 ²⁾
13					1.2	2.5	3.9	6.0 ²⁾	6.0 ²⁾	6.0 ²⁾
16					1.0	2.1	3.0	5.5	6.0 ²⁾	6.0 ²⁾
20					1.0	2.0	2.7	5.0	6.0 ²⁾	6.0 ²⁾
25						1.9	2.6	4.5	6.0 ²⁾	6.0 ²⁾
32							2.1	3.4	6.0 ²⁾	6.0 ²⁾
40								3.0	6.0 ²⁾	6.0 ²⁾

Short-circuit Selectivity PKN6-./1N/ towards NH-00 fuse link

In case of short-circuit, there is selectivity between the combined RCD/MCB devices PKN6-./1N/ and the upstream fuses up to the specified values of the selectivity limit current I_s [kA] (i. e. in case of short-circuit currents I_{ks} under I_s , only the MCB will trip, in case of short-circuit currents above this value both protective devices will respond).

*) basically in accordance with EN 60898-1 D.5.2.b

Short-circuit selectivity **Characteristic B** towards fuse link **NH-00***

PKN6	NH-00 gL/gG												
	I_n [A]	16	20	25	32	35	40	50	63	80	100	125	160
2	<0.5 ¹⁾	1.1	3.6	6.0 ²⁾	6.0 ²⁾	6.0 ²⁾	6.0 ²⁾	6.0 ²⁾	6.0 ²⁾	6.0 ²⁾	6.0 ²⁾	6.0 ²⁾	6.0 ²⁾
4	<0.5 ¹⁾	0.5	0.9	1.6	2.8	4.4	6.0 ²⁾	6.0 ²⁾	6.0 ²⁾	6.0 ²⁾	6.0 ²⁾	6.0 ²⁾	6.0 ²⁾
6	<0.5 ¹⁾	0.5	0.8	1.4	2.2	3.3	6.0 ²⁾	6.0 ²⁾	6.0 ²⁾	6.0 ²⁾	6.0 ²⁾	6.0 ²⁾	6.0 ²⁾
8	<0.5 ¹⁾	<0.5 ¹⁾	0.7	1.0	1.9	2.8	5.3	6.0 ²⁾	6.0 ²⁾	6.0 ²⁾	6.0 ²⁾	6.0 ²⁾	6.0 ²⁾
10		<0.5 ¹⁾	0.7	0.9	1.5	2.1	3.4	4.3	6.0 ²⁾	6.0 ²⁾	6.0 ²⁾	6.0 ²⁾	6.0 ²⁾
13		<0.5 ¹⁾	0.6	0.8	1.4	1.8	2.8	3.6	5.7	6.0 ²⁾	6.0 ²⁾	6.0 ²⁾	6.0 ²⁾
16			0.6	0.7	1.2	1.5	2.4	3.0	4.5	6.0 ²⁾	6.0 ²⁾	6.0 ²⁾	6.0 ²⁾
20				0.7	1.1	1.5	2.2	2.8	4.2	6.0 ²⁾	6.0 ²⁾	6.0 ²⁾	6.0 ²⁾
25					0.7	1.1	1.4	2.1	2.6	4.0	6.0 ²⁾	6.0 ²⁾	6.0 ²⁾
32						1.0	1.4	2.0	2.5	3.7	6.0 ²⁾	6.0 ²⁾	6.0 ²⁾
40								2.3	3.4	6.0 ²⁾	6.0 ²⁾	6.0 ²⁾	6.0 ²⁾

Short-circuit selectivity **Characteristic C** towards fuse link **NH-00***

PKN6	NH-00 gL/gG												
	I_n [A]	16	20	25	32	35	40	50	63	80	100	125	160
2	<0.5 ¹⁾	0.6	2.6	6.0 ²⁾	6.0 ²⁾	6.0 ²⁾	6.0 ²⁾	6.0 ²⁾	6.0 ²⁾	6.0 ²⁾	6.0 ²⁾	6.0 ²⁾	6.0 ²⁾
4	<0.5 ¹⁾	<0.5 ¹⁾	0.9	1.8	3.2	4.8	6.0 ²⁾	6.0 ²⁾	6.0 ²⁾	6.0 ²⁾	6.0 ²⁾	6.0 ²⁾	6.0 ²⁾
5	<0.5 ¹⁾	<0.5 ¹⁾	0.8	1.6	2.7	4.1	6.0 ²⁾	6.0 ²⁾	6.0 ²⁾	6.0 ²⁾	6.0 ²⁾	6.0 ²⁾	6.0 ²⁾
6	<0.5 ¹⁾	<0.5 ¹⁾	0.7	1.3	2.2	3.3	5.9	6.0 ²⁾	6.0 ²⁾	6.0 ²⁾	6.0 ²⁾	6.0 ²⁾	6.0 ²⁾
8	<0.5 ¹⁾	<0.5 ¹⁾	0.6	1.1	1.9	2.8	5.0	6.0 ²⁾	6.0 ²⁾	6.0 ²⁾	6.0 ²⁾	6.0 ²⁾	6.0 ²⁾
10			0.5	0.8	1.2	1.7	2.7	3.4	5.5	6.0 ²⁾	6.0 ²⁾	6.0 ²⁾	6.0 ²⁾
13					1.1	1.5	2.3	2.9	4.7	6.0 ²⁾	6.0 ²⁾	6.0 ²⁾	6.0 ²⁾
16					1.0	1.3	1.8	2.3	3.7	6.0 ²⁾	6.0 ²⁾	6.0 ²⁾	6.0 ²⁾
20						0.9	1.1	1.7	2.2	3.4	6.0 ²⁾	6.0 ²⁾	6.0 ²⁾
25							1.6	2.1	3.2	6.0 ²⁾	6.0 ²⁾	6.0 ²⁾	6.0 ²⁾
32								1.7	2.6	5.3	6.0 ²⁾	6.0 ²⁾	6.0 ²⁾
40									2.4	4.5	6.0 ²⁾	6.0 ²⁾	6.0 ²⁾

1) Selectivity limit current I_s under 0.5 kA.

2) Selectivity limit current I_s = rated breaking capacity I_{cn} of the RCD/MCB device

Darker areas: no selectivity



Let-through Energy PKN6-../1N/

Let-through Energy PKN6, Characteristic B, 1+N-pole

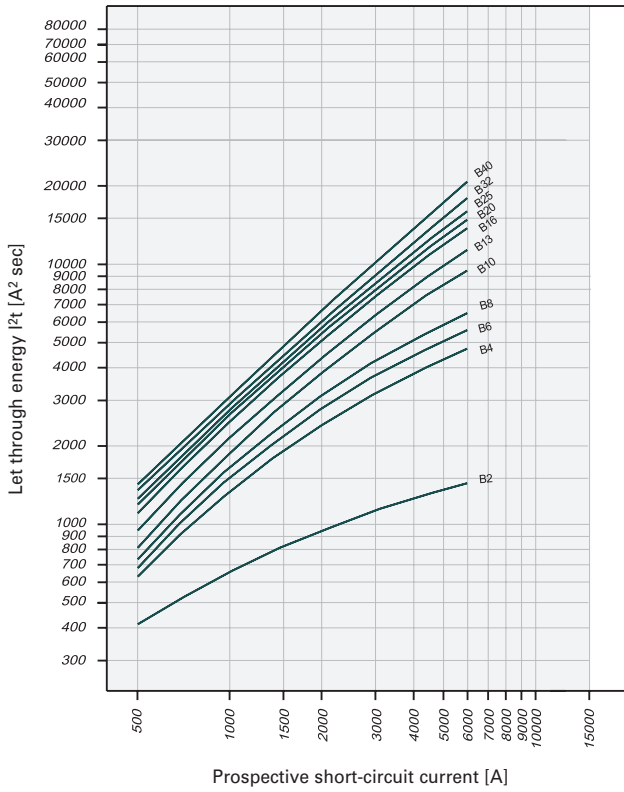

Let-through Energy PKN6, Characteristic C, 1+N-pole

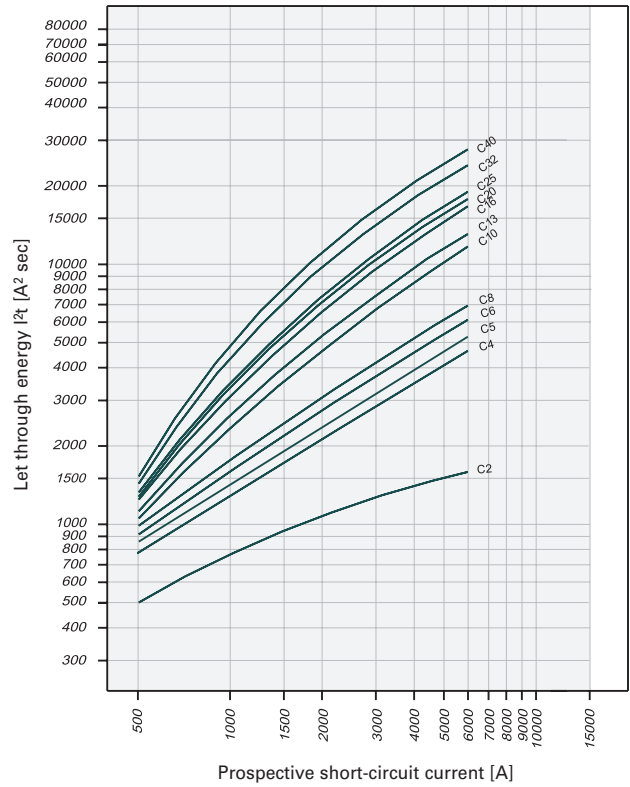

SG13911



Description

- High-quality residual current device / miniature circuit breaker combination, line voltage-independent
- Contact position indicator red - green
- Guide for secure terminal connection
- 3-position DIN rail clip, permits removal from existing busbar system
- Comprehensive range of accessories can be mounted subsequently
- Wide variety of rated tripping currents
- Rated currents up to 40 A
- Tripping characteristics B, C
- Rated breaking capacity 4.5 kA

$I_n/I_{\Delta n}$ (A)	Type Designation	Article No.	Units per package
---------------------------	---------------------	-------------	----------------------

Type A

4.5 kA, 1+N-pole

Conditionally surge current-proof 250 A, sensitive to residual pulsating DC, type A

SG13911



Characteristic B

6/0.03	PKN4-6/1N/B/003-A	236868	1/60
10/0.03	PKN4-10/1N/B/003-A	236928	1/60
13/0.03	PKN4-13/1N/B/003-A	236989	1/60
16/0.03	PKN4-16/1N/B/003-A	237061	1/60
20/0.03	PKN4-20/1N/B/003-A	237095	1/60
25/0.03	PKN4-25/1N/B/003-A	237125	1/60
32/0.03	PKN4-32/1N/B/003-A	237155	1/60
40/0.03	PKN4-40/1N/B/003-A	237184	1/60
6/0.3	PKN4-6/1N/B/03-A	236870	1/60
10/0.3	PKN4-10/1N/B/03-A	236930	1/60
13/0.3	PKN4-13/1N/B/03-A	236991	1/60
16/0.3	PKN4-16/1N/B/03-A	237063	1/60
20/0.3	PKN4-20/1N/B/03-A	237097	1/60
25/0.3	PKN4-25/1N/B/03-A	237127	1/60
32/0.3	PKN4-32/1N/B/03-A	237157	1/60
40/0.3	PKN4-40/1N/B/03-A	237186	1/60

SG13911



Characteristic C

6/0.03	PKN4-6/1N/C/003-A	236878	1/60
10/0.03	PKN4-10/1N/C/003-A	236938	1/60
13/0.03	PKN4-13/1N/C/003-A	237001	1/60
16/0.03	PKN4-16/1N/C/003-A	237073	1/60
20/0.03	PKN4-20/1N/C/003-A	237105	1/60
25/0.03	PKN4-25/1N/C/003-A	237135	1/60
32/0.03	PKN4-32/1N/C/003-A	237165	1/60
40/0.03	PKN4-40/1N/C/003-A	237194	1/60
6/0.3	PKN4-6/1N/C/03-A	236880	1/60
10/0.3	PKN4-10/1N/C/03-A	236940	1/60
13/0.3	PKN4-13/1N/C/03-A	237003	1/60
16/0.3	PKN4-16/1N/C/03-A	237075	1/60
20/0.3	PKN4-20/1N/C/03-A	237107	1/60
25/0.3	PKN4-25/1N/C/03-A	237137	1/60
32/0.3	PKN4-32/1N/C/03-A	237167	1/60
40/0.3	PKN4-40/1N/C/03-A	237196	1/60

$I_n/I_{\Delta n}$ (A)	Type Designation	Article No.	Units per package
---------------------------	---------------------	-------------	----------------------

Type AC

4.5 kA, 1+N-pole
Conditionally surge current-proof 250 A, type AC

SG13911



Characteristic B

6/0.03	PKN4-6/1N/B/003	236863	1/60
10/0.03	PKN4-10/1N/B/003	236923	1/60
13/0.03	PKN4-13/1N/B/003	236984	1/60
16/0.03	PKN4-16/1N/B/003	237056	1/60
20/0.03	PKN4-20/1N/B/003	237091	1/60
25/0.03	PKN4-25/1N/B/003	237121	1/60
32/0.03	PKN4-32/1N/B/003	237151	1/60
40/0.03	PKN4-40/1N/B/003	237180	1/60
6/0.3	PKN4-6/1N/B/03	236865	1/60
10/0.3	PKN4-10/1N/B/03	236925	1/60
13/0.3	PKN4-13/1N/B/03	236986	1/60
16/0.3	PKN4-16/1N/B/03	237058	1/60
20/0.3	PKN4-20/1N/B/03	237093	1/60
25/0.3	PKN4-25/1N/B/03	237123	1/60
32/0.3	PKN4-32/1N/B/03	237153	1/60
40/0.3	PKN4-40/1N/B/03	237182	1/60

SG13911



Characteristic C

6/0.03	PKN4-6/1N/C/003	236873	1/60
10/0.03	PKN4-10/1N/C/003	236933	1/60
13/0.03	PKN4-13/1N/C/003	236996	1/60
16/0.03	PKN4-16/1N/C/003	237068	1/60
20/0.03	PKN4-20/1N/C/003	237101	1/60
25/0.03	PKN4-25/1N/C/003	237131	1/60
32/0.03	PKN4-32/1N/C/003	237161	1/60
40/0.03	PKN4-40/1N/C/003	237190	1/60
6/0.3	PKN4-6/1N/C/03	236875	1/60
10/0.3	PKN4-10/1N/C/03	236935	1/60
13/0.3	PKN4-13/1N/C/03	236998	1/60
16/0.3	PKN4-16/1N/C/03	237070	1/60
20/0.3	PKN4-20/1N/C/03	237103	1/60
25/0.3	PKN4-25/1N/C/03	237133	1/60
32/0.3	PKN4-32/1N/C/03	237163	1/60
40/0.3	PKN4-40/1N/C/03	237192	1/60

Specifications | Combined RCD/MCB Devices PKN4, 1+N-pole

Description

- Combined RCD/MCB Devices
- Line voltage-independent tripping
- Compatible with standard busbar
- Twin-purpose terminal (lift/open-mouthed) above and below
- Busbar positioning optionally above or below
- Free terminal space despite installed busbar
- Guide for secure terminal connection
- Switching toggle (MCB component) in colour designating the rated current
- Contact position indicator red - green
- Comprehensive range of accessories can be mounted subsequently
- The test key "T" must be pressed every 6 month. The system operator must be informed of this obligation and his responsibility in a way that can be proven (self-adhesive RCD-label enclosed). The test interval of 6 month is valid for residential and similar applications. Under all other conditions (e.g. damply or dusty environments), it's recommended to test in shorter intervals (e.g. monthly).
- Pressing the test key "T" serves the only purpose of function testing the residual current device (RCD). This test does not make earthing resistance measurement (R_E), or proper checking of the earth conductor condition redundant, which must be performed separately.
- **Type -A:** Protects against special forms of residual pulsating DC which have not been smoothed.
- **Type -G:** 10 ms time delay in order to avoid unwanted tripping (e.g. during thunderstorms). Suitable for any circuit where personal injury or damage to property may occur in case of unwanted tripping.

Accessories:

Auxiliary switch for subsequent installation	ZP-IHK	286052
	ZP-WHK	286053
Tripping signal switch for subsequent installation	ZP-NHK	248437
Shunt trip release	ZP-ASA/..	248438, 248439
Additional terminal 35 mm ²	BB-UL-TEPA/35	169823

Technical Data

		PKN4, 1+N-pole
Electrical		
Design according to		IEC/EN 61009
Current test marks as printed onto the device		
Line voltage-independent tripping		instantaneous 250 A (8/20 μs), surge current proof
Type G		10 ms delay 3 kA (8/20 μs), surge current proof
Rated voltage	U_e	230 V AC; 50 Hz
Operational voltage range		196-253 V
Rated tripping current	$I_{\Delta n}$	10, 30, 100, 300 mA
Rated non-tripping current	$I_{\Delta no}$	0.5 $I_{\Delta n}$
Rated insulation voltage	U_i	440 VAC
Sensitivity		AC and pulsating DC
Selectivity class		3
Rated breaking capacity	I_{cn}	4.5 kA
Rated current		2 - 40 A
Rated impulse withstand voltage	U_{imp}	4 kV (1.2/50 μs)
Characteristic		B, C
Maximum back-up fuse (short-circuit)		100 A gL (>4.5 kA)
Endurance		
electrical components		≥ 4,000 switching operations
mechanical components		≥ 20,000 switching operations
Mechanical		
Frame size		45 mm
Device height		80 mm
Device width		35 mm (2 MU)
Mounting		3-position DIN rail clip, permits removal from existing busbar system
Degree of protection, switch		IP20
Degree of protection, built-in		IP40
Upper and lower terminals		open-mouthed/lift terminals
Terminal protection		finger and hand touch safe, DGUV VS3, EN 50274
Terminal capacity		1 - 25 mm ²
Terminal torque		2 - 2.4 Nm
Busbar thickness		0.8 - 2 mm
Operating temperature		-25°C to +55°C
Storage- and transport temperature		-35°C to +60°C
Resistance to climatic conditions		according to IEC/EN 61009

Connection diagram

1+N-pole

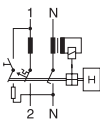

Dimensions (mm)

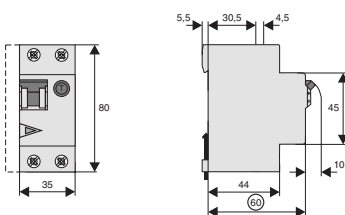

Load Capacity PKN4-../1N/

Effect of ambient temperature (MCB component)

I _n [A]	Ambient temperature T [°C]							
	-25	-15	-5	10	30	40	45	55
6	7	6.8	6.6	6.4	6	5.7	5.6	5.3
10	12.3	11.9	11.4	10.8	10	9.5	9.3	8.8
13	15.1	14.7	14.3	13.7	13	12.5	12.3	11.8
16	19.1	18.6	18	17.1	16	15.2	14.9	14.1
20	24.8	23.9	23	21.7	20	19	18.5	17.5
25	31.4	30.2	29.1	27.3	25	23.9	23.3	22.1
32	40.1	38.6	37.1	34.9	32	30.4	29.6	28
40	51	49	47	44	40	38.1	37.1	35.1

Tripping Characteristic PKN4-../1N/, Characteristics B and C

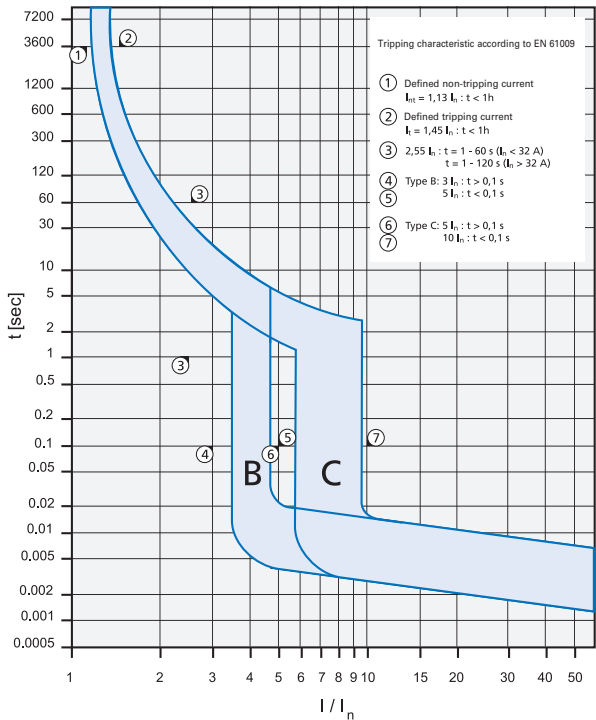

Short-circuit Selectivity PKN4-../1N/ towards DII-DIV fuse link

In case of short-circuit, there is selectivity between the combined RCD/MCB devices PKN4-../1N/ and the upstream fuses up to the specified values of the selectivity limit current I_s [kA] (i. e. in case of short-circuit currents I_{ks} under I_s , only the MCB will trip, in case of short-circuit currents above this value both protective devices will respond).

*) basically in accordance with EN 60898-1 D.5.2.b

Short-circuit selectivity **Characteristic B** towards fuse link **DII-DIV***

PKN4 I _n [A]	DII-DIV gL/gG								
	10	16	20	25	35	50	63	80	100
2	<0.5 ¹⁾	<0.5 ¹⁾	2.2	4.5 ²⁾	4.5 ²⁾	4.5 ²⁾	4.5 ²⁾	4.5 ²⁾	4.5 ²⁾
4	<0.5 ¹⁾	<0.5 ¹⁾	0.7	1.2	3.7	4.5 ²⁾	4.5 ²⁾	4.5 ²⁾	4.5 ²⁾
6		<0.5 ¹⁾	0.7	1.0	2.9	4.5 ²⁾	4.5 ²⁾	4.5 ²⁾	4.5 ²⁾
8		<0.5 ¹⁾	0.6	1.0	2.4	4.5 ²⁾	4.5 ²⁾	4.5 ²⁾	4.5 ²⁾
10			0.6	0.9	1.9	3.3	4.5 ²⁾	4.5 ²⁾	4.5 ²⁾
13			0.5	0.7	1.6	2.8	4.5 ²⁾	4.5 ²⁾	4.5 ²⁾
16				0.7	1.4	2.4	4.4	4.5 ²⁾	4.5 ²⁾
20					1.3	2.2	4.0	4.5 ²⁾	4.5 ²⁾
25						1.3	2.1	3.8	4.5 ²⁾
32							2.0	3.5	4.5 ²⁾
40								3.1	4.5 ²⁾

Short-circuit selectivity **Characteristic C** towards fuse link **DII-DIV***

PKN4 I _n [A]	DII-DIV gL/gG								
	10	16	20	25	35	50	63	80	100
2	<0.5 ¹⁾	<0.5 ¹⁾	1.7	4.5 ²⁾	4.5 ²⁾	4.5 ²⁾	4.5 ²⁾	4.5 ²⁾	4.5 ²⁾
4	<0.5 ¹⁾	<0.5 ¹⁾	0.7	1.3	4.2	4.5 ²⁾	4.5 ²⁾	4.5 ²⁾	4.5 ²⁾
5	<0.5 ¹⁾	<0.5 ¹⁾	0.6	1.1	3.6	4.5 ²⁾	4.5 ²⁾	4.5 ²⁾	4.5 ²⁾
6		<0.5 ¹⁾	0.6	1.0	2.9	4.5 ²⁾	4.5 ²⁾	4.5 ²⁾	4.5 ²⁾
8		<0.5 ¹⁾	<0.5	0.9	2.5	4.5 ²⁾	4.5 ²⁾	4.5 ²⁾	4.5 ²⁾
10			<0.5	0.7	1.5	2.6	4.5 ²⁾	4.5 ²⁾	4.5 ²⁾
13					1.4	2.3	4.5 ²⁾	4.5 ²⁾	4.5 ²⁾
16						1.2	1.8	3.4	4.5 ²⁾
20							1.2	1.7	3.1
25								1.6	2.9
32									2.3
40									2.9

1) Selectivity limit current I_s under 0.5 kA.

2) Selectivity limit current I_s = rated breaking capacity I_{cn} of the RCD/MCB device

Darker areas: no selectivity



Short-circuit Selectivity PKN4-./1N/ towards D01-D03 fuse link

In case of short-circuit, there is selectivity between the combined RCD/MCB devices PKN4-./1N/ and the upstream fuses up to the specified values of the selectivity limit current I_s [kA] (i. e. in case of short-circuit currents I_{ks} under I_s , only the MCB will trip, in case of short-circuit currents above this value both protective devices will respond).

*) basically in accordance with EN 60898-1 D.5.2.b

Short-circuit selectivity **Characteristic B** towards fuse link **D01-D03***

PKN4	D01-D03 gL/gG									
I_n [A]	10	16	20	25	35	50	63	80	100	
2	<0.5 ¹⁾	0.7	1.6	3.3	4.5 ²⁾	4.5 ²⁾	4.5 ²⁾	4.5 ²⁾	4.5 ²⁾	4.5 ²⁾
4	<0.5 ¹⁾	<0.5 ¹⁾	0.6	0.9	2.9	4.5 ²⁾	4.5 ²⁾	4.5 ²⁾	4.5 ²⁾	4.5 ²⁾
6		<0.5 ¹⁾	0.5	0.8	2.4	4.5 ²⁾	4.5 ²⁾	4.5 ²⁾	4.5 ²⁾	4.5 ²⁾
8			0.6	0.8	2.0	4.5 ²⁾	4.5 ²⁾	4.5 ²⁾	4.5 ²⁾	4.5 ²⁾
10			0.5	0.8	1.6	3.7	4.5 ²⁾	4.5 ²⁾	4.5 ²⁾	4.5 ²⁾
13			0.6	0.7	1.4	3.0	4.5 ²⁾	4.5 ²⁾	4.5 ²⁾	4.5 ²⁾
16				0.6	1.2	2.6	3.9	4.5 ²⁾	4.5 ²⁾	4.5 ²⁾
20					1.2	2.5	3.6	4.5 ²⁾	4.5 ²⁾	4.5 ²⁾
25					1.2	2.3	3.3	4.5 ²⁾	4.5 ²⁾	4.5 ²⁾
32						2.3	3.1	4.5 ²⁾	4.5 ²⁾	4.5 ²⁾
40							2.8	4.5 ²⁾	4.5 ²⁾	4.5 ²⁾

Short-circuit selectivity **Characteristic C** towards fuse link **D01-D03***

PKN4	D01-D03 gL/gG									
I_n [A]	10	16	20	25	35	50	63	80	100	
2	<0.5 ¹⁾	0.5	0.5	2.4	4.5 ²⁾	4.5 ²⁾	4.5 ²⁾	4.5 ²⁾	4.5 ²⁾	4.5 ²⁾
4	<0.5 ¹⁾	<0.5 ¹⁾	<0.5 ¹⁾	0.9	3.4	4.5 ²⁾	4.5 ²⁾	4.5 ²⁾	4.5 ²⁾	4.5 ²⁾
5	<0.5 ¹⁾	<0.5 ¹⁾	<0.5 ¹⁾	0.9	2.9	4.5 ²⁾	4.5 ²⁾	4.5 ²⁾	4.5 ²⁾	4.5 ²⁾
6		<0.5 ¹⁾	<0.5 ¹⁾	0.8	2.3	4.5 ²⁾	4.5 ²⁾	4.5 ²⁾	4.5 ²⁾	4.5 ²⁾
8			<0.5	0.7	2.1	4.5 ²⁾	4.5 ²⁾	4.5 ²⁾	4.5 ²⁾	4.5 ²⁾
10			<0.5	0.6	1.3	2.9	4.5 ²⁾	4.5 ²⁾	4.5 ²⁾	4.5 ²⁾
13					1.2	2.5	3.9	4.5 ²⁾	4.5 ²⁾	4.5 ²⁾
16					1.0	2.1	3.0	4.5 ²⁾	4.5 ²⁾	4.5 ²⁾
20					1.0	2.0	2.7	4.5 ²⁾	4.5 ²⁾	4.5 ²⁾
25						1.9	2.6	4.5 ²⁾	4.5 ²⁾	4.5 ²⁾
32							2.1	3.4	4.5 ²⁾	4.5 ²⁾
40								3.0	4.5 ²⁾	4.5 ²⁾

Short-circuit Selectivity PKN4-./1N/ towards NH-00 fuse link

In case of short-circuit, there is selectivity between the combined RCD/MCB devices PKN4-./1N/ and the upstream fuses up to the specified values of the selectivity limit current I_s [kA] (i. e. in case of short-circuit currents I_{ks} under I_s , only the MCB will trip, in case of short-circuit currents above this value both protective devices will respond).

*) basically in accordance with EN 60898-1 D.5.2.b

Short-circuit selectivity **Characteristic B** towards fuse link **NH-00***

PKN4	NH-00 gL/gG											
I_n [A]	16	20	25	32	35	40	50	63	80	100	125	160
2	<0.5 ¹⁾	1.1	3.6	4.5 ²⁾	4.5 ²⁾	4.5 ²⁾	4.5 ²⁾	4.5 ²⁾	4.5 ²⁾	4.5 ²⁾	4.5 ²⁾	4.5 ²⁾
4	<0.5 ¹⁾	0.5	0.9	1.6	2.8	4.4	4.5 ²⁾	4.5 ²⁾	4.5 ²⁾	4.5 ²⁾	4.5 ²⁾	4.5 ²⁾
6	<0.5 ¹⁾	0.5	0.8	1.4	2.2	3.3	4.5 ²⁾	4.5 ²⁾	4.5 ²⁾	4.5 ²⁾	4.5 ²⁾	4.5 ²⁾
8	<0.5 ¹⁾	<0.5 ¹⁾	0.7	1.0	1.9	2.8	4.5 ²⁾	4.5 ²⁾	4.5 ²⁾	4.5 ²⁾	4.5 ²⁾	4.5 ²⁾
10		<0.5 ¹⁾	0.7	0.9	1.5	2.1	3.4	4.3	4.5 ²⁾	4.5 ²⁾	4.5 ²⁾	4.5 ²⁾
13		<0.5 ¹⁾	0.6	0.8	1.4	1.8	2.8	3.6	4.5 ²⁾	4.5 ²⁾	4.5 ²⁾	4.5 ²⁾
16			0.6	0.7	1.2	1.5	2.4	3.0	4.5 ²⁾	4.5 ²⁾	4.5 ²⁾	4.5 ²⁾
20				0.7	1.1	1.5	2.2	2.8	4.2	4.5 ²⁾	4.5 ²⁾	4.5 ²⁾
25				0.7	1.1	1.4	2.1	2.6	4.0	4.5 ²⁾	4.5 ²⁾	4.5 ²⁾
32					1.0	1.4	2.0	2.5	3.7	4.5 ²⁾	4.5 ²⁾	4.5 ²⁾
40							2.3	3.4	4.5 ²⁾	4.5 ²⁾	4.5 ²⁾	4.5 ²⁾

Short-circuit selectivity **Characteristic C** towards fuse link **NH-00***

PKN4	NH-00 gL/gG											
I_n [A]	16	20	25	32	35	40	50	63	80	100	125	160
2	<0.5 ¹⁾	0.6	2.6	4.5 ²⁾	4.5 ²⁾	4.5 ²⁾	4.5 ²⁾	4.5 ²⁾	4.5 ²⁾	4.5 ²⁾	4.5 ²⁾	4.5 ²⁾
4	<0.5 ¹⁾	<0.5 ¹⁾	0.9	1.8	3.2	4.5 ²⁾	4.5 ²⁾	4.5 ²⁾	4.5 ²⁾	4.5 ²⁾	4.5 ²⁾	4.5 ²⁾
5	<0.5 ¹⁾	<0.5 ¹⁾	0.8	1.6	2.7	4.1	4.5 ²⁾	4.5 ²⁾	4.5 ²⁾	4.5 ²⁾	4.5 ²⁾	4.5 ²⁾
6	<0.5 ¹⁾	<0.5 ¹⁾	0.7	1.3	2.2	3.3	4.5 ²⁾	4.5 ²⁾	4.5 ²⁾	4.5 ²⁾	4.5 ²⁾	4.5 ²⁾
8	<0.5 ¹⁾	<0.5 ¹⁾	0.6	1.1	1.9	2.8	4.5 ²⁾	4.5 ²⁾	4.5 ²⁾	4.5 ²⁾	4.5 ²⁾	4.5 ²⁾
10			0.5	0.8	1.2	1.7	2.7	3.4	4.5 ²⁾	4.5 ²⁾	4.5 ²⁾	4.5 ²⁾
13					1.1	1.5	2.3	2.9	4.5 ²⁾	4.5 ²⁾	4.5 ²⁾	4.5 ²⁾
16					1.0	1.3	1.8	2.3	3.7	4.5 ²⁾	4.5 ²⁾	4.5 ²⁾
20					0.9	1.1	1.7	2.2	3.4	4.5 ²⁾	4.5 ²⁾	4.5 ²⁾
25						1.6	2.1	3.2	4.5 ²⁾	4.5 ²⁾	4.5 ²⁾	4.5 ²⁾
32							1.7	2.6	4.5 ²⁾	4.5 ²⁾	4.5 ²⁾	4.5 ²⁾
40								2.4	4.5 ²⁾	4.5 ²⁾	4.5 ²⁾	4.5 ²⁾

¹⁾ Selectivity limit current I_s under 0.5 kA.
²⁾ Selectivity limit current I_s = rated breaking capacity I_{cn} of the RCD/MCB device
 Darker areas: no selectivity

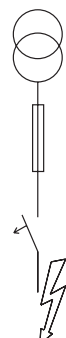

Let-through Energy PKN4-../1N/

Let-through Energy PKN4, Characteristic B, 1+N-pole

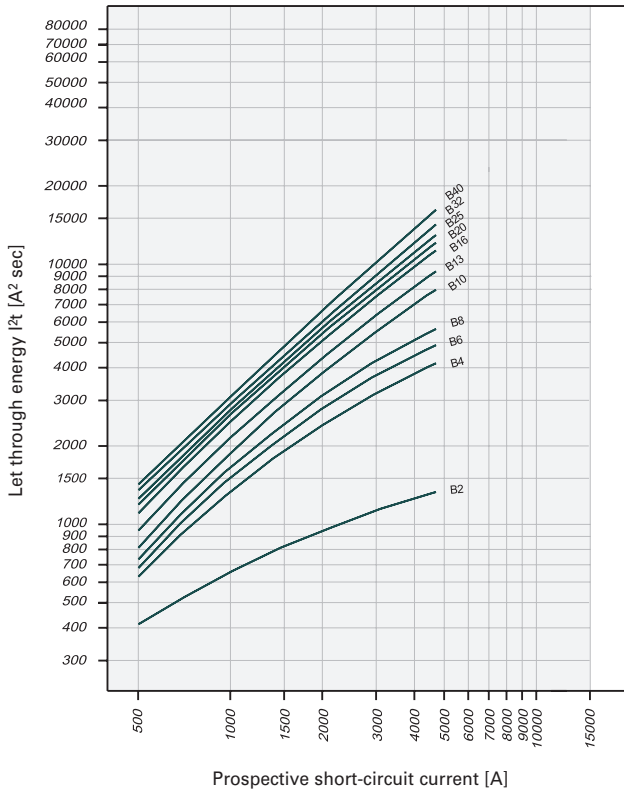

Let-through Energy PKN4, Characteristic C, 1+N-pole

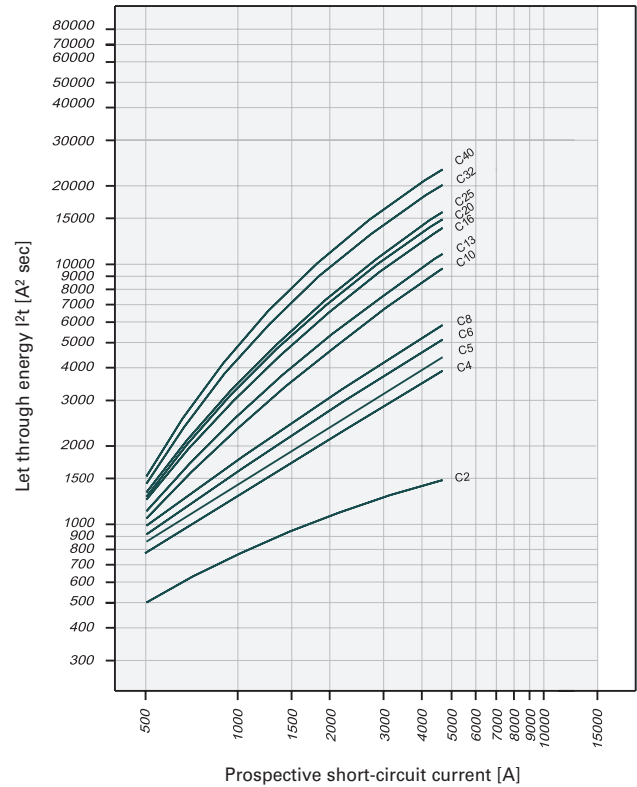

SG61711



Description

- Residual current device / miniature circuit breaker combination, line voltage-independent
- Contact position indicator red - green
- Guide for secure terminal connection
- 3-position DIN rail clip, permits removal from existing busbar system
- Comprehensive range of accessories can be mounted subsequently
- Rated currents up to 40 A
- Tripping characteristics B, C
- Rated breaking capacity 10 kA
- Frost resistance 

$I_n/I_{\Delta n}$ (A)	Type Designation	Article No.	Units per package
---------------------------	---------------------	-------------	----------------------

Type A

10 kA, 1+N-pole

Conditionally surge current-proof 250 A, sensitive to residual pulsating DC, type A

SG61711



Characteristic B

6/0.03	PFL7-6/1N/B/003-A	263431	1/60
10/0.03	PFL7-10/1N/B/003-A	263435	1/60
13/0.03	PFL7-13/1N/B/003-A	263519	1/60
16/0.03	PFL7-16/1N/B/003-A	263535	1/60
20/0.03	PFL7-20/1N/B/003-A	263541	1/60
25/0.03	PFL7-25/1N/B/003-A	263547	1/60
32/0.03	PFL7-32/1N/B/003-A	263553	1/60
40/0.03	PFL7-40/1N/B/003-A	263559	1/60
6/0.3	PFL7-6/1N/B/03-A	165704	1/60
10/0.3	PFL7-10/1N/B/03-A	165591	1/60
13/0.3	PFL7-13/1N/B/03-A	165603	1/60
16/0.3	PFL7-16/1N/B/03-A	165617	1/60
20/0.3	PFL7-20/1N/B/03-A	165645	1/60
25/0.3	PFL7-25/1N/B/03-A	165655	1/60
32/0.3	PFL7-32/1N/B/03-A	165666	1/60
40/0.3	PFL7-40/1N/B/03-A	165691	1/60

SG61711



Characteristic C

6/0.03	PFL7-6/1N/C/003-A	263515	1/60
10/0.03	PFL7-10/1N/C/003-A	263517	1/60
13/0.03	PFL7-13/1N/C/003-A	263532	1/60
16/0.03	PFL7-16/1N/C/003-A	263538	1/60
20/0.03	PFL7-20/1N/C/003-A	263544	1/60
25/0.03	PFL7-25/1N/C/003-A	263550	1/60
32/0.03	PFL7-32/1N/C/003-A	263556	1/60
40/0.03	PFL7-40/1N/C/003-A	263562	1/60
6/0.3	PFL7-6/1N/C/03-A	165710	1/60
10/0.3	PFL7-10/1N/C/03-A	165597	1/60
13/0.3	PFL7-13/1N/C/03-A	165610	1/60
16/0.3	PFL7-16/1N/C/03-A	165624	1/60
20/0.3	PFL7-20/1N/C/03-A	165650	1/60
25/0.3	PFL7-25/1N/C/03-A	165660	1/60
32/0.3	PFL7-32/1N/C/03-A	165671	1/60
40/0.3	PFL7-40/1N/C/03-A	165696	1/60

$I_n/I_{\Delta n}$ (A)	Type Designation	Article No.	Units per package
---------------------------	---------------------	-------------	----------------------

Type AC

10 kA, 1+N-pole
Conditionally surge current-proof 250 A, type AC

SG61711



Characteristic B

6/0.03	PFL7-6/1N/B/003	263430	1/60
10/0.03	PFL7-10/1N/B/003	263434	1/60
13/0.03	PFL7-13/1N/B/003	263518	1/60
16/0.03	PFL7-16/1N/B/003	263534	1/60
20/0.03	PFL7-20/1N/B/003	263540	1/60
25/0.03	PFL7-25/1N/B/003	263546	1/60
32/0.03	PFL7-32/1N/B/003	263552	1/60
40/0.03	PFL7-40/1N/B/003	263558	1/60
6/0.3	PFL7-6/1N/B/03	165705	1/60
10/0.3	PFL7-10/1N/B/03	165592	1/60
13/0.3	PFL7-13/1N/B/03	165605	1/60
16/0.3	PFL7-16/1N/B/03	165619	1/60
20/0.3	PFL7-20/1N/B/03	165647	1/60
25/0.3	PFL7-25/1N/B/03	165657	1/60
32/0.3	PFL7-32/1N/B/03	165668	1/60
40/0.3	PFL7-40/1N/B/03	165693	1/60

SG61711



Characteristic C

6/0.03	PFL7-6/1N/C/003	263432	1/60
10/0.03	PFL7-10/1N/C/003	263516	1/60
13/0.03	PFL7-13/1N/C/003	263531	1/60
16/0.03	PFL7-16/1N/C/003	263537	1/60
20/0.03	PFL7-20/1N/C/003	263543	1/60
25/0.03	PFL7-25/1N/C/003	263549	1/60
32/0.03	PFL7-32/1N/C/003	263555	1/60
40/0.03	PFL7-40/1N/C/003	263561	1/60
6/0.3	PFL7-6/1N/C/03	165711	1/60
10/0.3	PFL7-10/1N/C/03	165598	1/60
13/0.3	PFL7-13/1N/C/03	165612	1/60
16/0.3	PFL7-16/1N/C/03	165626	1/60
20/0.3	PFL7-20/1N/C/03	165652	1/60
25/0.3	PFL7-25/1N/C/03	165662	1/60
32/0.3	PFL7-32/1N/C/03	165673	1/60
40/0.3	PFL7-40/1N/C/03	165698	1/60

Specifications | Combined RCD/MCB Devices PFL7, 1+N-pole

Description

- Combined RCD/MCB Devices
- Line voltage-independent tripping
- Twin-purpose terminal (lift/open-mouthed) above and below
- Busbar positioning optionally above or below
- Free terminal space despite installed busbar
- Guide for secure terminal connection
- Switching toggle (MCB component) in colour designating the rated current
- Contact position indicator red - green
- Comprehensive range of accessories can be mounted subsequently
- The test key "T" must be pressed every 6 month. The system operator must be informed of this obligation and his responsibility in a way that can be proven (self-adhesive RCD-label enclosed). The test interval of 6 month is valid for residential and similar applications. Under all other conditions (e.g. damply or dusty environments), it's recommended to test in shorter intervals (e.g. monthly).
- Pressing the test key "T" serves the only purpose of function testing the residual current device (RCD). This test does not make earthing resistance measurement (R_E), or proper checking of the earth conductor condition redundant, which must be performed separately.
- **Type -A:** Protects against special forms of residual pulsating DC which have not been smoothed.
- **Type -G:** 10 ms time delay in order to avoid unwanted tripping (e.g. during thunderstorms). Suitable for any circuit where personal injury or damage to property may occur in case of unwanted tripping.

Accessories:

Auxiliary switch for subsequent installation	ZP-IHK	286052
	ZP-WHK	286053
Tripping signal switch for subsequent installation	ZP-NHK	248437
Shunt trip release	ZP-ASA/..	248438, 248439
Additional terminal 35 mm ²	BB-UL-TEPA/35	169823

Technical Data

		PFL7, 1+N-pole
Electrical		
Design according to		IEC/EN 61009
Current test marks as printed onto the device		
Line voltage-independent tripping		instantaneous 250 A (8/20 μs), surge current proof
Type G		10 ms delay 3 kA (8/20 μs), surge current proof
Rated voltage	U_e	230 V AC; 50 Hz
Operational voltage range		196-253 V
Rated tripping current	$I_{\Delta n}$	10, 30, 100, 300, 500 mA
Rated non-tripping current	$I_{\Delta no}$	0.5 $I_{\Delta n}$
Rated insulation voltage	U_i	440 VAC
Sensitivity		AC and pulsating DC
Selectivity class		3
Rated breaking capacity	I_{cn}	10 kA
Rated current		6 - 40 A
Rated impulse withstand voltage	U_{imp}	6 kV (1.2/50 μs)
Characteristic		B, C
Maximum back-up fuse (short-circuit)		100 A gL (>10 kA)
Endurance		
electrical components		≥ 4,000 switching operations
mechanical components		≥ 20,000 switching operations
Mechanical		
Frame size		45 mm
Device height		80 mm
Device width		35 mm (2 MU)
Mounting		3-position DIN rail clip, permits removal from existing busbar system
Degree of protection, switch		IP20
Degree of protection, built-in		IP40
Upper and lower terminals		open-mouthed/lift terminals
Terminal protection		finger and hand touch safe, DGUV VS3, EN 50274
Terminal capacity		1 - 25 mm ²
Terminal torque		2 - 2.4 Nm
Busbar thickness		0.8 - 2 mm
Operating temperature		-25°C to +55°C
Storage- and transport temperature		-35°C to +60°C
Resistance to climatic conditions		according to IEC/EN 61009

Connection diagram

1+N-pole

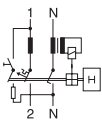

Dimensions (mm)

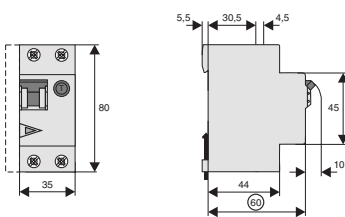

Load Capacity PFL7-../1N/

Effect of ambient temperature (MCB component)

I _n [A]	Ambient temperature T [°C]							
	-25	-15	-5	10	30	40	45	55
6	7	6.8	6.6	6.4	6	5.7	5.6	5.3
10	12.3	11.9	11.4	10.8	10	9.5	9.3	8.8
13	15.1	14.7	14.3	13.7	13	12.5	12.3	11.8
16	19.1	18.6	18	17.1	16	15.2	14.9	14.1
20	24.8	23.9	23	21.7	20	19	18.5	17.5
25	31.4	30.2	29.1	27.3	25	23.9	23.3	22.1
32	40.1	38.6	37.1	34.9	32	30.4	29.6	28
40	51	49	47	44	40	38.1	37.1	35.1

Tripping Characteristic PFL7-../1N/, Characteristics B and C

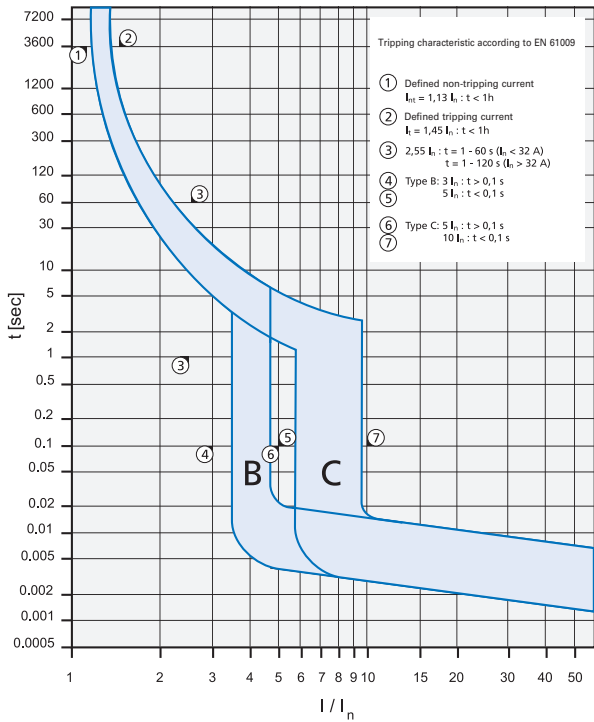

Short-circuit Selectivity PFL7-../1N/ towards DII-DIV fuse link

In case of short-circuit, there is selectivity between the combined RCD/MCB devices PFL7-../1N/ and the upstream fuses up to the specified values of the selectivity limit current I_s [kA] (i. e. in case of short-circuit currents I_{cs} under I_s , only the MCB will trip, in case of short-circuit currents above this value both protective devices will respond).

*) basically in accordance with EN 60898-1 D.5.2.b

Short-circuit selectivity **Characteristic B** towards fuse link **DII-DIV***

PFL7 I _n [A]	DII-DIV gL/gG								
	10	16	20	25	35	50	63	80	100
6		<0.5 ¹⁾	0.7	1.0	2.9	6.9	10.0 ²⁾	10.0 ²⁾	10.0 ²⁾
8		<0.5 ¹⁾	0.6	1.0	2.4	5.1	10.0 ²⁾	10.0 ²⁾	10.0 ²⁾
10			0.6	0.9	1.9	3.3	7.0	10.0 ²⁾	10.0 ²⁾
13			0.5	0.7	1.6	2.8	5.7	9.0	10.0 ²⁾
16				0.7	1.4	2.4	4.4	7.0	10.0 ²⁾
20					1.3	2.2	4.0	6.3	10.0 ²⁾
25					1.3	2.1	3.8	5.8	10.0 ²⁾
32						2.0	3.5	5.2	9.5
40							3.1	4.5	8.1

Short-circuit selectivity **Characteristic C** towards fuse link **DII-DIV***

PFL7 I _n [A]	DII-DIV gL/gG								
	10	16	20	25	35	50	63	80	100
6		<0.5 ¹⁾	0.6	1.0	2.9	5.8	10.0 ²⁾	10.0 ²⁾	10.0 ²⁾
8		<0.5 ¹⁾	<0.5	0.9	2.5	4.8	10.0 ²⁾	10.0 ²⁾	10.0 ²⁾
10			<0.5	0.7	1.5	2.6	5.3	9.0	10.0 ²⁾
13					1.4	2.3	4.6	7.6	10.0 ²⁾
16					1.2	1.8	3.4	5.5	10.0 ²⁾
20					1.2	1.7	3.1	5.0	10.0 ²⁾
25						1.6	2.9	4.6	10.0 ²⁾
32							2.3	3.4	7.7
40								2.9	6.2

¹⁾ Selectivity limit current I_s under 0.5 kA.

²⁾ Selectivity limit current I_s = rated breaking capacity I_{cn} of the RCD/MCB device

Darker areas: no selectivity



Short-circuit Selectivity PFL7-../1N/ towards D01-D03 fuse link

In case of short-circuit, there is selectivity between the combined RCD/MCB devices PFL7-../1N/ and the upstream fuses up to the specified values of the selectivity limit current I_s [kA] (i. e. in case of short-circuit currents I_{ks} under I_s , only the MCB will trip, in case of short-circuit currents above this value both protective devices will respond).

*) basically in accordance with EN 60898-1 D.5.2.b

Short-circuit selectivity **Characteristic B** towards fuse link **D01-D03***

PFL7 I_n [A]	D01-D03 gL/gG								
	10	16	20	25	35	50	63	80	100
6	<0.5 ¹⁾	0.5	0.8	2.4	8.2	10.0 ²⁾	10.0 ²⁾	10.0 ²⁾	
8		0.6	0.8	2.0	6.0	10.0 ²⁾	10.0 ²⁾	10.0 ²⁾	
10		0.5	0.8	1.6	3.7	6.0	10.0 ²⁾	10.0 ²⁾	
13		0.6	0.7	1.4	3.0	4.7	9.0	10.0 ²⁾	
16			0.6	1.2	2.6	3.9	7.0	10.0 ²⁾	
20				1.2	2.5	3.6	6.2	10.0 ²⁾	
25					1.2	2.3	3.3	5.7	10.0 ²⁾
32						2.3	3.1	5.1	10.0 ²⁾
40							2.8	4.5	9.5

Short-circuit selectivity **Characteristic C** towards fuse link **D01-D03***

PFL7 I_n [A]	D01-D03 gL/gG								
	10	16	20	25	35	50	63	80	100
6	<0.5 ¹⁾	<0.5 ¹⁾	0.8	2.3	6.5	10.0 ²⁾	10.0 ²⁾	10.0 ²⁾	
8		<0.5	0.7	2.1	5.5	9.5	10.0 ²⁾	10.0 ²⁾	
10		<0.5	0.6	1.3	2.9	4.5	8.9	10.0 ²⁾	
13				1.2	2.5	3.9	7.6	10.0 ²⁾	
16				1.0	2.1	3.0	5.5	10.0 ²⁾	
20					1.0	2.0	2.7	5.0	10.0 ²⁾
25						1.9	2.6	4.5	10.0 ²⁾
32							2.1	3.4	10.0 ²⁾
40								3.0	8.7

Short-circuit Selectivity PFL7-../1N/ towards NH-00 fuse link

In case of short-circuit, there is selectivity between the combined RCD/MCB devices PFL7-../1N/ and the upstream fuses up to the specified values of the selectivity limit current I_s [kA] (i. e. in case of short-circuit currents I_{ks} under I_s , only the MCB will trip, in case of short-circuit currents above this value both protective devices will respond).

*) basically in accordance with EN 60898-1 D.5.2.b

Short-circuit selectivity **Characteristic B** towards fuse link **NH-00***

PFL7 I_n [A]	NH-00 gL/gG											
	16	20	25	32	35	40	50	63	80	100	125	160
6	<0.5 ¹⁾	0.5	0.8	1.4	2.2	3.3	7.0	10.0 ²⁾	10.0 ²⁾	10.0 ²⁾	10.0 ²⁾	10.0 ²⁾
10		<0.5 ¹⁾	0.7	0.9	1.5	2.1	3.4	4.3	7.3	10.0 ²⁾	10.0 ²⁾	10.0 ²⁾
13		<0.5 ¹⁾	0.6	0.8	1.4	1.8	2.8	3.6	5.7	10.0 ²⁾	10.0 ²⁾	10.0 ²⁾
16			0.6	0.7	1.2	1.5	2.4	3.0	4.5	10.0 ²⁾	10.0 ²⁾	10.0 ²⁾
20				0.7	1.1	1.5	2.2	2.8	4.2	9.2	10.0 ²⁾	10.0 ²⁾
25				0.7	1.1	1.4	2.1	2.6	4.0	8.2	10.0 ²⁾	10.0 ²⁾
32					1.0	1.4	2.0	2.5	3.7	7.1	10.0 ²⁾	10.0 ²⁾
40							2.3	3.4	6.2	8.8	10.0 ²⁾	

Short-circuit selectivity **Characteristic C** towards fuse link **NH-00***

PFL7 I_n [A]	NH-00 gL/gG											
	16	20	25	32	35	40	50	63	80	100	125	160
6	<0.5 ¹⁾	<0.5 ¹⁾	0.7	1.3	2.2	3.3	5.9	8.0	10.0 ²⁾	10.0 ²⁾	10.0 ²⁾	10.0 ²⁾
10			0.5	0.8	1.2	1.7	2.7	3.4	5.5	10.0 ²⁾	10.0 ²⁾	10.0 ²⁾
13					1.1	1.5	2.3	2.9	4.7	10.0 ²⁾	10.0 ²⁾	10.0 ²⁾
16					1.0	1.3	1.8	2.3	3.7	8.7	10.0 ²⁾	10.0 ²⁾
20					0.9	1.1	1.7	2.2	3.4	8.0	10.0 ²⁾	10.0 ²⁾
25						1.6	2.1	3.2	7.2	10.0 ²⁾	10.0 ²⁾	
32							1.7	2.6	5.3	9.0	10.0 ²⁾	
40								2.4	4.5	7.5	10.0	

¹⁾ Selectivity limit current I_s under 0.5 kA.

²⁾ Selectivity limit current I_s = rated breaking capacity I_{cn} of the RCD/MCB device

Darker areas: no selectivity



Let-through Energy PFL7-../1N/

Let-through Energy PFL7, Characteristic B, 1+N-pole

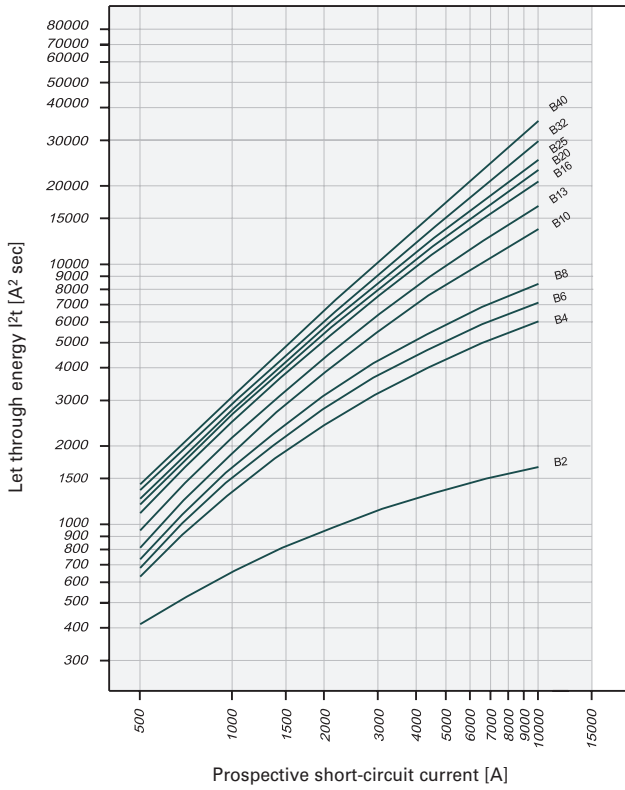

Let-through Energy PFL7, Characteristic C, 1+N-pole

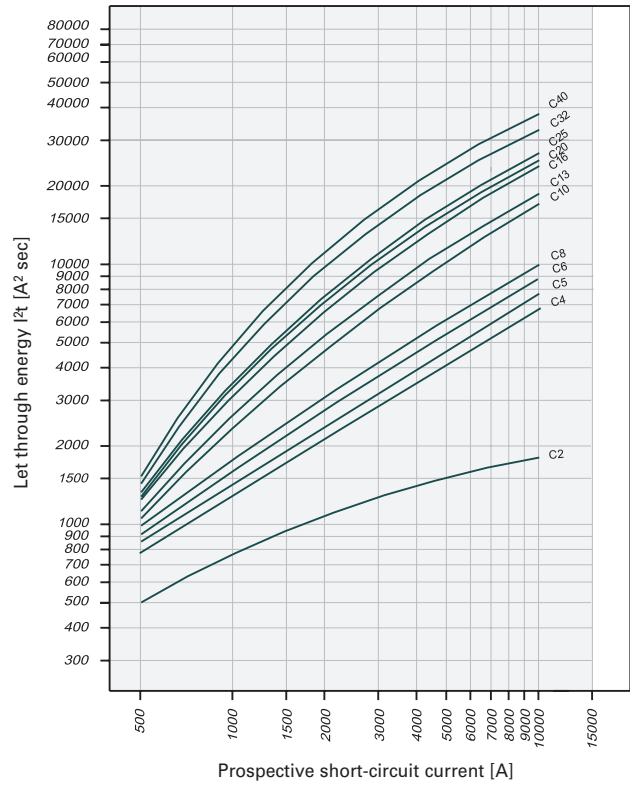

SG04414



Description

- Economy series mainly for house installations
- Residual current device / miniature circuit breaker combination, line voltage-independent
- Contact position indicator red - green
- Comprehensive range of accessories can be mounted subsequently
- Rated currents up to 25 A
- Tripping characteristics B, C
- Rated breaking capacity 6 kA
- Frost resistance 

$I_n/I_{\Delta n}$ (A)	Type Designation	Article No.	Units per package
---------------------------	---------------------	-------------	----------------------

Type AC

6 kA, 1+N-pole
Conditionally surge current-proof 250 A, type AC

SG04414



Characteristic B

6/0.03	PFL6-6/1N/B/003	286428	1/60
10/0.03	PFL6-10/1N/B/003	286429	1/60
13/0.03	PFL6-13/1N/B/003	286430	1/60
16/0.03	PFL6-16/1N/B/003	286431	1/60
20/0.03	PFL6-20/1N/B/003	286432	1/60
25/0.03	PFL6-25/1N/B/003	286433	1/60

SG04414



Characteristic C

6/0.03	PFL6-6/1N/C/003	286464	1/60
10/0.03	PFL6-10/1N/C/003	286465	1/60
13/0.03	PFL6-13/1N/C/003	286466	1/60
16/0.03	PFL6-16/1N/C/003	286467	1/60
20/0.03	PFL6-20/1N/C/003	286468	1/60
25/0.03	PFL6-25/1N/C/003	286469	1/60

Specifications | Combined RCD/MCB Devices PFL6, 1+N-pole

Description

- Combined RCD/MCB Devices
- Line voltage-independent tripping
- Twin-purpose terminal (lift/open-mouthed) above and below
- Busbar positioning optionally above or below
- Free terminal space despite installed busbar
- Guide for secure terminal connection
- Contact position indicator red - green
- Comprehensive range of accessories can be mounted subsequently
- The test key "T" must be pressed every 6 month. The system operator must be informed of this obligation and his responsibility in a way that can be proven (self-adhesive RCD-label enclosed). The test intervall of 6 month is valid for residential and similar applications. Under all other conditions (e.g. damply or dusty environments), it's recommended to test in shorter intervalls (e.g. monthly).
- Pressing the test key "T" serves the only purpose of function testing the residual current device (RCD). This test does not make earthing resistance measurement (R_E), or proper checking of the earth conductor condition redundant, which must be performed separately.

Accessories:

Auxiliary switch for subsequent installation	ZP-IHK	286052
	ZP-WHK	286053
Tripping signal switch for subsequent installation	ZP-NHK	248437
Shunt trip release	ZP-ASA/..	248438, 248439
Additional terminal 35 mm ²	BB-UL-TEPA/35	169823

Technical Data

		PFL6, 1+N-pole
Electrical		
Design according to		IEC/EN 61009
Current test marks as printed onto the device		
Line voltage-independent tripping		instantaneous 250 A (8/20 μ s), surge current proof
Rated voltage	U_e	230 V AC; 50 Hz
Operational voltage range		196-253 V
Rated tripping current	$I_{\Delta n}$	30 mA
Rated non-tripping current	$I_{\Delta no}$	0.5 $I_{\Delta n}$
Rated insulation voltage	U_i	440 VAC
Sensitivity		AC
Selectivity class		3
Rated breaking capacity	I_{cn}	6 kA
Rated current		6 - 25 A
Rated impulse withstand voltage	U_{imp}	4 kV (1.2/50 μ s)
Characteristic		B, C
Maximum back-up fuse (short-circuit)		100 A gL (>6 kA)
Endurance		
electrical components		$\geq 4,000$ switching operations
mechanical components		$\geq 20,000$ switching operations
Mechanical		
Frame size		45 mm
Device height		80 mm
Device width		35 mm (2 MU)
Mounting		3-position DIN rail clip, permits removal from existing busbar system
Degree of protection, switch		IP20
Degree of protection, built-in		IP40
Upper and lower terminals		open-mouthed/lift terminals
Terminal protection		finger and hand touch safe, DGUV VS3, EN 50274
Terminal capacity		1 - 25 mm ²
Terminal torque		2 - 2.4 Nm
Busbar thickness		0.8 - 2 mm
Operating temperature		-25°C to +55°C
Storage- and transport temperature		-35°C to +60°C
Resistance to climatic conditions		according to IEC/EN 61009

Connection diagram

1+N-pole

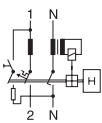

Dimensions (mm)

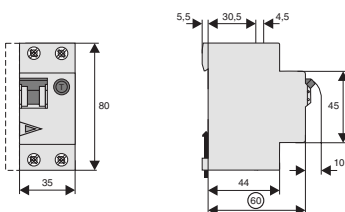

Load Capacity PFL6-../1N/

Effect of ambient temperature (MCB component)

I _n [A]	Ambient temperature T [°C]							
	-25	-15	-5	10	30	40	45	55
6	7	6.8	6.6	6.4	6	5.7	5.6	5.3
10	12.3	11.9	11.4	10.8	10	9.5	9.3	8.8
13	15.1	14.7	14.3	13.7	13	12.5	12.3	11.8
16	19.1	18.6	18	17.1	16	15.2	14.9	14.1
20	24.8	23.9	23	21.7	20	19	18.5	17.5
25	31.4	30.2	29.1	27.3	25	23.9	23.3	22.1

Tripping Characteristic PFL6-../1N/, Characteristics B and C

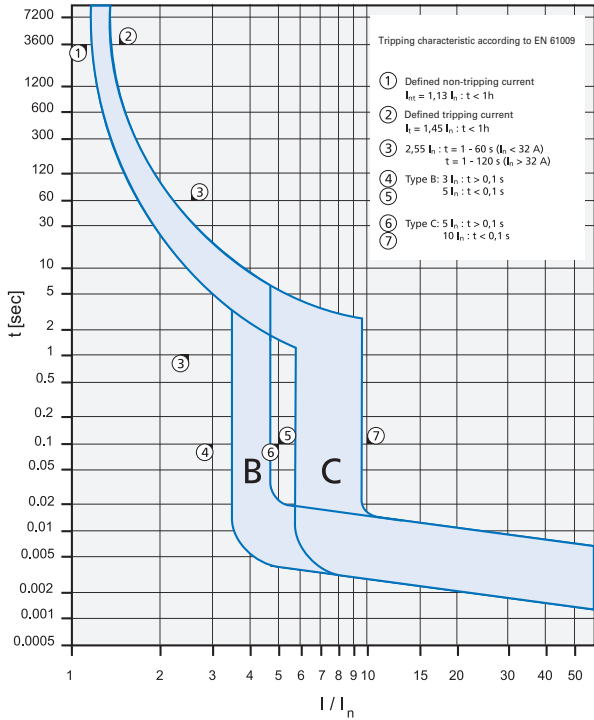

Short-circuit Selectivity PFL6-../1N/ towards DII-DIV fuse link

In case of short-circuit, there is selectivity between the combined RCD/MCB devices PFL6-../1N/ and the upstream fuses up to the specified values of the selectivity limit current I_s [kA] (i. e. in case of short-circuit currents I_{sc} under I_s, only the MCB will trip, in case of short-circuit currents above this value both protective devices will respond).

*) basically in accordance with EN 60898-1 D.5.2.b

Short-circuit selectivity **Characteristic B** towards fuse link **DII-DIV***

PFL6 I _n [A]	DII-DIV gL/gG								
	10	16	20	25	35	50	63	80	100
6	<0.5 ¹⁾	0.7	1.0	2.9	6.0 ²⁾	6.0 ²⁾	6.0 ²⁾	6.0 ²⁾	6.0 ²⁾
8	<0.5 ¹⁾	0.6	1.0	2.4	5.1	6.0 ²⁾	6.0 ²⁾	6.0 ²⁾	6.0 ²⁾
10		0.6	0.9	1.9	3.3	6.0 ²⁾	6.0 ²⁾	6.0 ²⁾	6.0 ²⁾
13		0.5	0.7	1.6	2.8	5.7	6.0 ²⁾	6.0 ²⁾	6.0 ²⁾
16			0.7	1.4	2.4	4.4	6.0 ²⁾	6.0 ²⁾	6.0 ²⁾
20				1.3	2.2	4.0	6.0 ²⁾	6.0 ²⁾	6.0 ²⁾
25				1.3	2.1	3.8	5.8	6.0 ²⁾	6.0 ²⁾

Short-circuit selectivity **Characteristic C** towards fuse link **DII-DIV***

PFL6 I _n [A]	DII-DIV gL/gG								
	10	16	20	25	35	50	63	80	100
6	<0.5 ¹⁾	0.6	1.0	2.9	5.8	6.0 ²⁾	6.0 ²⁾	6.0 ²⁾	6.0 ²⁾
8	<0.5 ¹⁾	<0.5	0.9	2.5	4.8	6.0 ²⁾	6.0 ²⁾	6.0 ²⁾	6.0 ²⁾
10		<0.5	0.7	1.5	2.6	5.3	6.0 ²⁾	6.0 ²⁾	6.0 ²⁾
13				1.4	2.3	4.6	6.0 ²⁾	6.0 ²⁾	6.0 ²⁾
16				1.2	1.8	3.4	5.5	6.0 ²⁾	6.0 ²⁾
20				1.2	1.7	3.1	5.0	6.0 ²⁾	6.0 ²⁾
25				1.6	2.9	4.6	6.0 ²⁾	6.0 ²⁾	6.0 ²⁾

¹⁾ Selectivity limit current I_s under 0.5 kA.

²⁾ Selectivity limit current I_s = rated breaking capacity I_{cn} of the RCD/MCB device

Darker areas: no selectivity



Short-circuit Selectivity PFL6-./1N/ towards D01-D03 fuse link

In case of short-circuit, there is selectivity between the combined RCD/MCB devices PFL6-./1N/ and the upstream fuses up to the specified values of the selectivity limit current I_s [kA] (i. e. in case of short-circuit currents I_{ks} under I_s , only the MCB will trip, in case of short-circuit currents above this value both protective devices will respond).

*) basically in accordance with EN 60898-1 D.5.2.b

Short-circuit selectivity **Characteristic B** towards fuse link **D01-D03***)

PFL6	D01-D03 gL/gG								
I_n [A]	10	16	20	25	35	50	63	80	100
6		<0.5 ¹⁾	0.5	0.8	2.4	6.0 ²⁾	6.0 ²⁾	6.0 ²⁾	6.0 ²⁾
8			0.6	0.8	2.0	6.0 ²⁾	6.0 ²⁾	6.0 ²⁾	6.0 ²⁾
10			0.5	0.8	1.6	3.7	6.0 ²⁾	6.0 ²⁾	6.0 ²⁾
13			0.6	0.7	1.4	3.0	4.7	6.0 ²⁾	6.0 ²⁾
16					0.6	1.2	2.6	3.9	6.0 ²⁾
20						1.2	2.5	3.6	6.0 ²⁾
25							1.2	2.3	3.3

Short-circuit selectivity **Characteristic C** towards fuse link **D01-D03***)

PFL6	D01-D03 gL/gG								
I_n [A]	10	16	20	25	35	50	63	80	100
6		<0.5 ¹⁾	<0.5 ¹⁾	0.8	2.3	6.0 ²⁾	6.0 ²⁾	6.0 ²⁾	6.0 ²⁾
8			<0.5	0.7	2.1	5.5	6.0 ²⁾	6.0 ²⁾	6.0 ²⁾
10			<0.5	0.6	1.3	2.9	4.5	6.0 ²⁾	6.0 ²⁾
13					1.2	2.5	3.9	6.0 ²⁾	6.0 ²⁾
16						1.0	2.1	3.0	5.5
20							1.0	2.0	2.7
25								1.9	2.6

Short-circuit Selectivity PFL6-./1N/ towards NH-00 fuse link

In case of short-circuit, there is selectivity between the combined RCD/MCB devices PFL6-./1N/ and the upstream fuses up to the specified values of the selectivity limit current I_s [kA] (i. e. in case of short-circuit currents I_{ks} under I_s , only the MCB will trip, in case of short-circuit currents above this value both protective devices will respond).

*) basically in accordance with EN 60898-1 D.5.2.b

Short-circuit selectivity **Characteristic B** towards fuse link **NH-00***)

PFL6	NH-00 gL/gG											
I_n [A]	16	20	25	32	35	40	50	63	80	100	125	160
6	<0.5 ¹⁾	0.5	0.8	1.4	2.2	3.3	6.0 ²⁾	6.0 ²⁾	6.0 ²⁾	6.0 ²⁾	6.0 ²⁾	6.0 ²⁾
10		<0.5 ¹⁾	0.7	0.9	1.5	2.1	3.4	4.3	6.0 ²⁾	6.0 ²⁾	6.0 ²⁾	6.0 ²⁾
13			<0.5 ¹⁾	0.6	0.8	1.4	1.8	2.8	3.6	5.7	6.0 ²⁾	6.0 ²⁾
16				0.6	0.7	1.2	1.5	2.4	3.0	4.5	6.0 ²⁾	6.0 ²⁾
20					0.7	1.1	1.5	2.2	2.8	4.2	6.0 ²⁾	6.0 ²⁾
25						0.7	1.1	1.4	2.1	2.6	4.0	6.0 ²⁾

Short-circuit selectivity **Characteristic C** towards fuse link **NH-00***)

PFL6	NH-00 gL/gG											
I_n [A]	16	20	25	32	35	40	50	63	80	100	125	160
6	<0.5 ¹⁾	<0.5 ¹⁾	0.7	1.3	2.2	3.3	5.9	6.0 ²⁾	6.0 ²⁾	6.0 ²⁾	6.0 ²⁾	6.0 ²⁾
10			0.5	0.8	1.2	1.7	2.7	3.4	5.5	6.0 ²⁾	6.0 ²⁾	6.0 ²⁾
13					1.1	1.5	2.3	2.9	4.7	6.0 ²⁾	6.0 ²⁾	6.0 ²⁾
16						1.0	1.3	1.8	2.3	3.7	6.0 ²⁾	6.0 ²⁾
20							0.9	1.1	1.7	2.2	3.4	6.0 ²⁾
25								1.6	2.1	3.2	6.0 ²⁾	6.0 ²⁾

¹⁾ Selectivity limit current I_s under 0.5 kA.

²⁾ Selectivity limit current I_s = rated breaking capacity I_{cn} of the RCD/MCB device

Darker areas: no selectivity



Let-through Energy PFL6-../1N/

Let-through Energy PFL6, Characteristic B, 1+N-pole

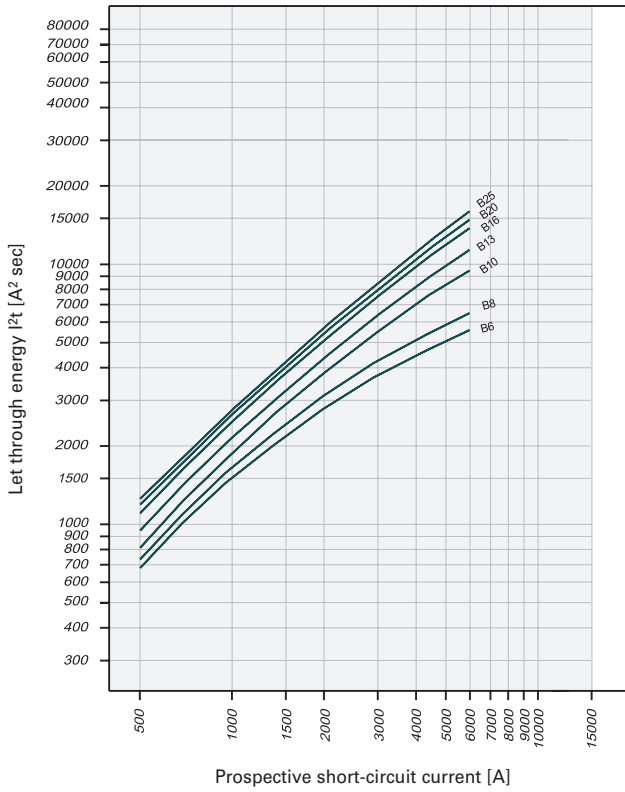

Let-through Energy PFL6, Characteristic C, 1+N-pole

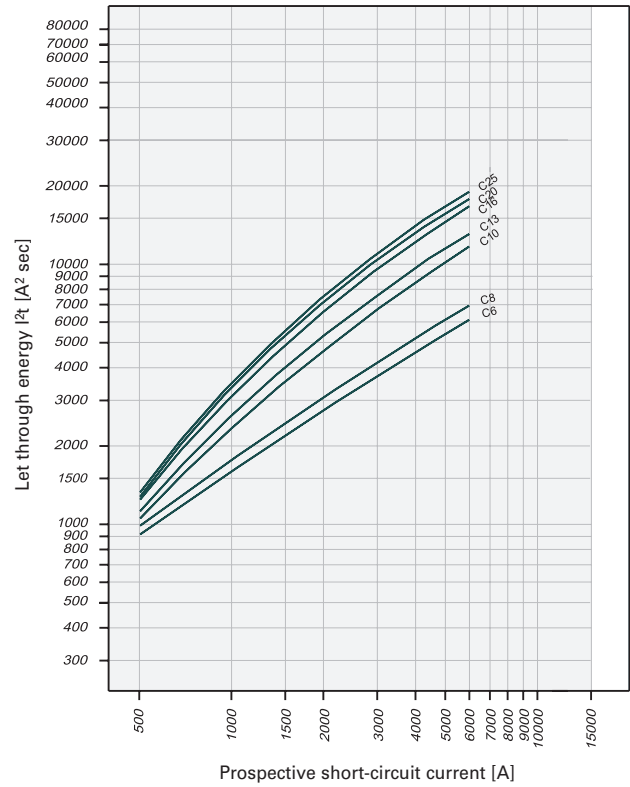

SG07911



Description

- Innovative, high-quality residual current device / miniature circuit breaker combination, line voltage-dependent
- Design width of one module unit only
- Specific for applications in the BS-distribution systems, permanently connected neutral conductors
- Contact position indicator red - green
- Comprehensive range of accessories can be mounted subsequently
- Guide for secure terminal connection
- Wide variety of rated tripping currents
- Rated currents up to 45 A
- Tripping characteristics B, C
- Rated breaking capacity 10 kA

$I_n/I_{\Delta n}$ (A)	Type Designation	Article No.	Units per package
---------------------------	---------------------	-------------	----------------------

Type A

10 kA, 1+N-pole

Conditionally surge current-proof 250 A, sensitive to residual pulsating DC, type A

SG07911



Characteristic B

6/0.01	eRBM-6/1/B/001-A	152065	1/30
8/0.01	eRBM-8/1/B/001-A	152066	1/30
10/0.01	eRBM-10/1/B/001-A	152067	1/30
13/0.01	eRBM-13/1/B/001-A	152068	1/30
16/0.01	eRBM-16/1/B/001-A	152069	1/30
20/0.01	eRBM-20/1/B/001-A	152070	1/30
25/0.01	eRBM-25/1/B/001-A	152071	1/30
32/0.01	eRBM-32/1/B/001-A	152072	1/30
40/0.01	eRBM-40/1/B/001-A	152073	1/30
45/0.01	eRBM-45/1/B/001-A	152074	1/30
6/0.03	eRBM-6/1/B/003-A	152075	1/30
8/0.03	eRBM-8/1/B/003-A	152076	1/30
10/0.03	eRBM-10/1/B/003-A	152077	1/30
13/0.03	eRBM-13/1/B/003-A	152078	1/30
16/0.03	eRBM-16/1/B/003-A	152079	1/30
20/0.03	eRBM-20/1/B/003-A	152080	1/30
25/0.03	eRBM-25/1/B/003-A	152081	1/30
32/0.03	eRBM-32/1/B/003-A	152082	1/30
40/0.03	eRBM-40/1/B/003-A	152083	1/30
45/0.03	eRBM-45/1/B/003-A	152084	1/30
6/0.1	eRBM-6/1/B/01-A	153066	1/30
8/0.1	eRBM-8/1/B/01-A	153067	1/30
10/0.1	eRBM-10/1/B/01-A	153068	1/30
13/0.1	eRBM-13/1/B/01-A	153069	1/30
16/0.1	eRBM-16/1/B/01-A	153070	1/30
20/0.1	eRBM-20/1/B/01-A	153071	1/30
25/0.1	eRBM-25/1/B/01-A	153072	1/30
32/0.1	eRBM-32/1/B/01-A	153073	1/30
40/0.1	eRBM-40/1/B/01-A	153074	1/30
45/0.1	eRBM-45/1/B/01-A	153075	1/30
6/0.3	eRBM-6/1/B/03-A	152085	1/30
8/0.3	eRBM-8/1/B/03-A	152086	1/30
10/0.3	eRBM-10/1/B/03-A	152087	1/30
13/0.3	eRBM-13/1/B/03-A	152088	1/30
16/0.3	eRBM-16/1/B/03-A	152089	1/30
20/0.3	eRBM-20/1/B/03-A	152090	1/30
25/0.3	eRBM-25/1/B/03-A	152091	1/30
32/0.3	eRBM-32/1/B/03-A	152092	1/30
40/0.3	eRBM-40/1/B/03-A	152093	1/30
45/0.3	eRBM-45/1/B/03-A	152094	1/30

1.4

Combined RCD/MCB Devices

xPole

Electronic Combined RCD/MCB Devices eRBM, 1+N-pole, 1MU

SG07911



$I_n/I_{\Delta n}$ (A)	Type Designation	Article No.	Units per package
Characteristic C			
6/0.01	eRBM-6/1/C/001-A	152175	1/30
8/0.01	eRBM-8/1/C/001-A	152176	1/30
10/0.01	eRBM-10/1/C/001-A	152177	1/30
13/0.01	eRBM-13/1/C/001-A	152178	1/30
16/0.01	eRBM-16/1/C/001-A	152179	1/30
20/0.01	eRBM-20/1/C/001-A	152180	1/30
25/0.01	eRBM-25/1/C/001-A	152181	1/30
32/0.01	eRBM-32/1/C/001-A	152182	1/30
40/0.01	eRBM-40/1/C/001-A	152183	1/30
45/0.01	eRBM-45/1/C/001-A	152184	1/30
6/0.03	eRBM-6/1/C/003-A	152185	1/30
8/0.03	eRBM-8/1/C/003-A	152186	1/30
10/0.03	eRBM-10/1/C/003-A	152187	1/30
13/0.03	eRBM-13/1/C/003-A	152188	1/30
16/0.03	eRBM-16/1/C/003-A	152189	1/30
20/0.03	eRBM-20/1/C/003-A	152190	1/30
25/0.03	eRBM-25/1/C/003-A	152191	1/30
32/0.03	eRBM-32/1/C/003-A	152192	1/30
40/0.03	eRBM-40/1/C/003-A	152193	1/30
45/0.03	eRBM-45/1/C/003-A	152194	1/30
6/0.1	eRBM-6/1/C/01-A	153106	1/30
8/0.1	eRBM-8/1/C/01-A	153107	1/30
10/0.1	eRBM-10/1/C/01-A	153108	1/30
13/0.1	eRBM-13/1/C/01-A	153109	1/30
16/0.1	eRBM-16/1/C/01-A	153110	1/30
20/0.1	eRBM-20/1/C/01-A	153111	1/30
25/0.1	eRBM-25/1/C/01-A	153112	1/30
32/0.1	eRBM-32/1/C/01-A	153113	1/30
40/0.1	eRBM-40/1/C/01-A	153114	1/30
45/0.1	eRBM-45/1/C/01-A	153115	1/30
6/0.3	eRBM-6/1/C/03-A	152195	1/30
8/0.3	eRBM-8/1/C/03-A	152196	1/30
10/0.3	eRBM-10/1/C/03-A	152197	1/30
13/0.3	eRBM-13/1/C/03-A	152198	1/30
16/0.3	eRBM-16/1/C/03-A	152199	1/30
20/0.3	eRBM-20/1/C/03-A	152200	1/30
25/0.3	eRBM-25/1/C/03-A	152201	1/30
32/0.3	eRBM-32/1/C/03-A	152202	1/30
40/0.3	eRBM-40/1/C/03-A	152203	1/30
45/0.3	eRBM-45/1/C/03-A	152204	1/30

Specifications | Electronic Combined RCD/MCB Devices eRBM, 1+N-pole, 1MU

Description

- Electronic residual current device / miniature circuit breaker combination in only 1MU
- Tripping line voltage dependent
- Contact position indicator red - green
- Can be sealed with leads in the ON and OFF position
- Colour coded switching toggle (designating the rated current)
- Permanently connected neutral conductor (950 mm long, blue)
- Special application in British-Standard-Distribution Boxes
- Can be connected to standard busbar (at the lower side)
- Comprehensive range of accessories can be mounted subsequently

Accessories:

Auxiliary switch for subsequent installation	Z-AHK	248433
Tripping signal switch for subsequent installation	Z-NHK	248434
Shunt trip release	Z-ASA/..	248286, 248287
Tripping module	Z-KAM	248294

Technical Data

		eRBM, 1+N-pole, 1MU
Electrical		
Design according to		BS/EN 61009
Current test marks as printed onto the device		
Number of poles		1+N-pole, pole switched, N led through (solid neutral)
Rated voltage	U_n	240 VAC
Rated frequency		50 Hz
Rated current	I_n	6 - 45 A
Rated tripping current	$I_{\Delta n}$	10, 30, 100, 300 mA
Sensitivity		pulsating DC
Tripping Characteristic RCD component		
Tripping line voltage dependent		instantaneous
Peak withstand current		250 A (8/20 μ s)
Rated non-tripping current	$I_{\Delta no}$	0.5 $I_{\Delta n}$
Voltage range for protective function		184 - 264 V~
Tripping Characteristic MCB component		
Conventional non-tripping current		1.13 I_n
Conventional tripping current		1.45 I_n
Reference temperature		30°C
Characteristic		B, C
Rated breaking capacity		10 kA
Selectivity class		3
Maximum back-up fuse (short-circuit)		100 A gL (>6 kA)
Endurance		
electrical components		$\geq 4,000$ switching operations
mechanical components		$\geq 20,000$ switching operations
Mechanical		
Frame size		45 mm
Device height		102.6 mm
Device width		17.7 mm (1MU)
Mounting		quick fastening with 2 lock-in positions on DIN rail IEC/EN 60715
Degree of protection, switch		IP20
Degree of protection, built-in		IP40
Upper terminals		lift terminals
Lower terminals		open-mouthed/lift terminals
Terminal protection		finger and hand touch safe, DGUV VS3, EN 50274
Terminal capacity		1 - 25 mm ²
Terminal torque		2 - 2.4 Nm
Busbar thickness		0.8 - 2 mm
Operating temperature		-25°C to +40°C
Storage- and transport temperature		-35°C to +60°C
Resistance to climatic conditions		25-55°C/90-95% relative humidity according to IEC 60068-2

Connection diagram

1+N-pole

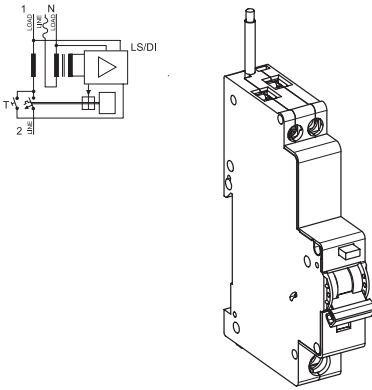

Dimensions (mm)

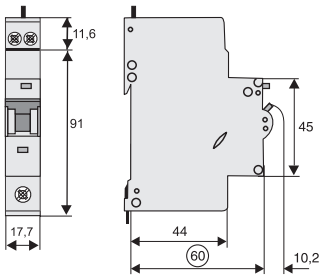

SG07911



Description

- Innovative, high-quality residual current device / miniature circuit breaker combination, line voltage-dependent
- Design width of one module unit only
- Specific for applications in the BS-distribution systems, permanently connected neutral conductors
- Contact position indicator red - green
- Comprehensive range of accessories can be mounted subsequently
- Guide for secure terminal connection
- Wide variety of rated tripping currents
- Rated currents up to 45 A
- Tripping characteristics B, C
- Rated breaking capacity 6 kA

SG07911



$I_n/I_{\Delta n}$ (A)	Type Designation	Article No.	Units per package
Type AC			
6 kA, 1+N-pole			
Conditionally surge current-proof 250 A, type AC			
Characteristic B			
6/0.01	eRB6-6/1/B/001	151975	1/30
8/0.01	eRB6-8/1/B/001	151976	1/30
10/0.01	eRB6-10/1/B/001	151977	1/30
13/0.01	eRB6-13/1/B/001	151978	1/30
16/0.01	eRB6-16/1/B/001	151979	1/30
20/0.01	eRB6-20/1/B/001	151990	1/30
25/0.01	eRB6-25/1/B/001	151991	1/30
32/0.01	eRB6-32/1/B/001	151992	1/30
40/0.01	eRB6-40/1/B/001	151993	1/30
45/0.01	eRB6-45/1/B/001	151994	1/30
6/0.03	eRB6-6/1/B/003	151995	1/30
6/0.03	eRB6-6/1/B/003-PT3	152277	1/30
8/0.03	eRB6-8/1/B/003	151996	1/30
10/0.03	eRB6-10/1/B/003	151997	1/30
13/0.03	eRB6-13/1/B/003	151998	1/30
16/0.03	eRB6-16/1/B/003	151999	1/30
20/0.03	eRB6-20/1/B/003	152000	1/30
25/0.03	eRB6-25/1/B/003	152001	1/30
32/0.03	eRB6-32/1/B/003	152002	1/30
32/0.03	eRB6-32/1/B/003-PT3	152278	1/30
40/0.03	eRB6-40/1/B/003	152003	1/30
45/0.03	eRB6-45/1/B/003	152004	1/30
6/0.1	eRB6-6/1/B/01	153036	1/30
8/0.1	eRB6-8/1/B/01	153037	1/30
10/0.1	eRB6-10/1/B/01	153038	1/30
13/0.1	eRB6-13/1/B/01	153039	1/30
16/0.1	eRB6-16/1/B/01	153040	1/30
20/0.1	eRB6-20/1/B/01	153041	1/30
25/0.1	eRB6-25/1/B/01	153042	1/30
32/0.1	eRB6-32/1/B/01	153043	1/30
40/0.1	eRB6-40/1/B/01	153044	1/30
45/0.1	eRB6-45/1/B/01	153045	1/30
6/0.3	eRB6-6/1/B/03	152005	1/30
8/0.3	eRB6-8/1/B/03	152006	1/30
10/0.3	eRB6-10/1/B/03	152007	1/30
13/0.3	eRB6-13/1/B/03	152008	1/30
16/0.3	eRB6-16/1/B/03	152009	1/30
20/0.3	eRB6-20/1/B/03	152010	1/30
25/0.3	eRB6-25/1/B/03	152011	1/30
32/0.3	eRB6-32/1/B/03	152012	1/30
40/0.3	eRB6-40/1/B/03	152013	1/30
45/0.3	eRB6-45/1/B/03	152014	1/30

SG07911



$I_n/I_{\Delta n}$ (A)	Type Designation	Article No.	Units per package
Characteristic C			
6/0.01	eRB6-6/1/C/001	152095	1/30
8/0.01	eRB6-8/1/C/001	152096	1/30
10/0.01	eRB6-10/1/C/001	152097	1/30
13/0.01	eRB6-13/1/C/001	152098	1/30
16/0.01	eRB6-16/1/C/001	152099	1/30
20/0.01	eRB6-20/1/C/001	152100	1/30
25/0.01	eRB6-25/1/C/001	152101	1/30
32/0.01	eRB6-32/1/C/001	152102	1/30
40/0.01	eRB6-40/1/C/001	152103	1/30
45/0.01	eRB6-45/1/C/001	152104	1/30
6/0.03	eRB6-6/1/C/003	152105	1/30
8/0.03	eRB6-8/1/C/003	152106	1/30
10/0.03	eRB6-10/1/C/003	152107	1/30
13/0.03	eRB6-13/1/C/003	152108	1/30
16/0.03	eRB6-16/1/C/003	152109	1/30
20/0.03	eRB6-20/1/C/003	152110	1/30
25/0.03	eRB6-25/1/C/003	152111	1/30
32/0.03	eRB6-32/1/C/003	152112	1/30
40/0.03	eRB6-40/1/C/003	152113	1/30
45/0.03	eRB6-45/1/C/003	152114	1/30
6/0.1	eRB6-6/1/C/01	153076	1/30
8/0.1	eRB6-8/1/C/01	153077	1/30
10/0.1	eRB6-10/1/C/01	153078	1/30
13/0.1	eRB6-13/1/C/01	153079	1/30
16/0.1	eRB6-16/1/C/01	153080	1/30
20/0.1	eRB6-20/1/C/01	153081	1/30
25/0.1	eRB6-25/1/C/01	153082	1/30
32/0.1	eRB6-32/1/C/01	153083	1/30
40/0.1	eRB6-40/1/C/01	153084	1/30
45/0.1	eRB6-45/1/C/01	153085	1/30
6/0.3	eRB6-6/1/C/03	152115	1/30
8/0.3	eRB6-8/1/C/03	152116	1/30
10/0.3	eRB6-10/1/C/03	152117	1/30
13/0.3	eRB6-13/1/C/03	152118	1/30
16/0.3	eRB6-16/1/C/03	152119	1/30
20/0.3	eRB6-20/1/C/03	152120	1/30
25/0.3	eRB6-25/1/C/03	152121	1/30
32/0.3	eRB6-32/1/C/03	152122	1/30
40/0.3	eRB6-40/1/C/03	152123	1/30
45/0.3	eRB6-45/1/C/03	152124	1/30

Specifications | Electronic Combined RCD/MCB Devices eRB6, 1+N-pole, 1MU

Description

- Electronic residual current device / miniature circuit breaker combination in only 1MU
- Tripping line voltage dependent
- Contact position indicator red - green
- Can be sealed with leads in the ON and OFF position
- Colour coded switching toggle (designating the rated current)
- Permanently connected neutral conductor
Standard version: 600 mm long, blue
PT3 version: 300 mm long, blue
- Special application in British-Standard-Distribution Boxes
- Can be connected to standard busbar (at the lower side)
- Comprehensive range of accessories can be mounted subsequently

Accessories:

Auxiliary switch for subsequent installation	Z-AHK	248433
Tripping signal switch for subsequent installation	Z-NHK	248434
Shunt trip release	Z-ASA/..	248286, 248287
Tripping module	Z-KAM	248294

Technical Data

		eRB6, 1+N-pole, 1MU
Electrical		
Design according to		BS/EN 61009
Current test marks as printed onto the device		
Number of poles		1+N-pole, pole switched, N led through (solid neutral)
Rated voltage	U_n	240 VAC
Rated frequency		50 Hz
Rated current	I_n	6 - 45 A
Rated tripping current	$I_{\Delta n}$	10, 30, 100, 300 mA
Sensitivity		AC
Tripping Characteristic RCD component		
Tripping line voltage dependent		instantaneous
Peak withstand current		250 A (8/20 μ s)
Rated non-tripping current	$I_{\Delta no}$	0.5 $I_{\Delta n}$
Voltage range for protective function		184 - 264 V~
Tripping Characteristic MCB component		
Conventional non-tripping current		1.13 I_n
Conventional tripping current		1.45 I_n
Reference temperature		30°C
Characteristic		B, C
Rated breaking capacity		6 kA
Selectivity class		3
Maximum back-up fuse (short-circuit)		100 A gL (>6 kA)
Endurance		
electrical components		$\geq 4,000$ switching operations
mechanical components		$\geq 20,000$ switching operations
Mechanical		
Frame size		45 mm
Device height		102.6 mm
Device width		17.7 mm (1MU)
Mounting		quick fastening with 2 lock-in positions on DIN rail IEC/EN 60715
Degree of protection, switch		IP20
Degree of protection, built-in		IP40
Upper terminals		lift terminals
Lower terminals		open-mouthed/lift terminals
Terminal protection		finger and hand touch safe, DGUV VS3, EN 50274
Terminal capacity		1 - 25 mm ²
Terminal torque		2 - 2.4 Nm
Busbar thickness		0.8 - 2 mm
Operating temperature		-25°C to +40°C
Storage- and transport temperature		-35°C to +60°C
Resistance to climatic conditions		25-55°C/90-95% relative humidity according to IEC 60068-2

Connection diagram

1+N-pole

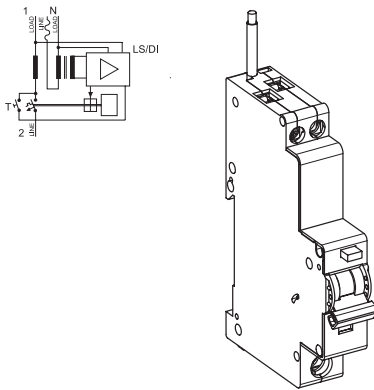

Dimensions (mm)

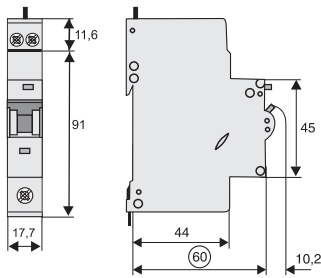

SG07911



Description

- Innovative, high-quality residual current device / miniature circuit breaker combination, line voltage-dependent
- Design width of one module unit only
- Specific for applications in the BS-distribution systems, permanently connected neutral conductors
- Contact position indicator red - green
- Comprehensive range of accessories can be mounted subsequently
- Guide for secure terminal connection
- Wide variety of rated tripping currents
- Rated currents up to 45 A
- Tripping Characteristic C
- Rated breaking capacity 10 kA

$I_n/I_{\Delta n}$ (A)	Type Designation	Article No.	Units per package
---------------------------	---------------------	-------------	----------------------

Type AC

10 kA, 1+N-pole
Conditionally surge current-proof 250 A, type AC

Characteristic C

6/0.01	eRBM-6/1/C/001-ME	153230	1/30
8/0.01	eRBM-8/1/C/001-ME	153231	1/30
10/0.01	eRBM-10/1/C/001-ME	153232	1/30
13/0.01	eRBM-13/1/C/001-ME	153233	1/30
16/0.01	eRBM-16/1/C/001-ME	153234	1/30
20/0.01	eRBM-20/1/C/001-ME	153235	1/30
25/0.01	eRBM-25/1/C/001-ME	153236	1/30
32/0.01	eRBM-32/1/C/001-ME	153237	1/30
40/0.01	eRBM-40/1/C/001-ME	153238	1/30
45/0.01	eRBM-45/1/C/001-ME	153239	1/30
6/0.03	eRBM-6/1/C/003-ME	153240	1/30
8/0.03	eRBM-8/1/C/003-ME	153241	1/30
10/0.03	eRBM-10/1/C/003-ME	153242	1/30
13/0.03	eRBM-13/1/C/003-ME	153243	1/30
16/0.03	eRBM-16/1/C/003-ME	153244	1/30
20/0.03	eRBM-20/1/C/003-ME	153245	1/30
25/0.03	eRBM-25/1/C/003-ME	153246	1/30
32/0.03	eRBM-32/1/C/003-ME	153247	1/30
40/0.03	eRBM-40/1/C/003-ME	153248	1/30
45/0.03	eRBM-45/1/C/003-ME	153249	1/30
6/0.1	eRBM-6/1/C/01-ME	153250	1/30
8/0.1	eRBM-8/1/C/01-ME	153251	1/30
10/0.1	eRBM-10/1/C/01-ME	153252	1/30
13/0.1	eRBM-13/1/C/01-ME	153253	1/30
16/0.1	eRBM-16/1/C/01-ME	153254	1/30
20/0.1	eRBM-20/1/C/01-ME	153255	1/30
25/0.1	eRBM-25/1/C/01-ME	153256	1/30
32/0.1	eRBM-32/1/C/01-ME	153257	1/30
40/0.1	eRBM-40/1/C/01-ME	153258	1/30
45/0.1	eRBM-45/1/C/01-ME	153259	1/30
6/0.3	eRBM-6/1/C/03-ME	153260	1/30
8/0.3	eRBM-8/1/C/03-ME	153261	1/30
10/0.3	eRBM-10/1/C/03-ME	153262	1/30
13/0.3	eRBM-13/1/C/03-ME	153263	1/30
16/0.3	eRBM-16/1/C/03-ME	153264	1/30
20/0.3	eRBM-20/1/C/03-ME	153265	1/30
25/0.3	eRBM-25/1/C/03-ME	153266	1/30
32/0.3	eRBM-32/1/C/03-ME	153267	1/30
40/0.3	eRBM-40/1/C/03-ME	153268	1/30
45/0.3	eRBM-45/1/C/03-ME	153269	1/30

SG07911



Specifications | Electronic Combined RCD/MCB Devices eRBM-ME, 1+N-pole, 1MU

Description

- Electronic residual current device / miniature circuit breaker combination in only 1MU
- Tripping line voltage dependent
- Contact position indicator red - green
- Can be sealed with leads in the ON and OFF position
- Colour coded switching toggle (designating the rated current)
- Permanently connected neutral conductor (950 mm long, black)
- Special application in British-Standard-Distribution Boxes
- Can be connected to standard busbar (at the lower side)
- Comprehensive range of accessories can be mounted subsequently

Accessories:

Auxiliary switch for subsequent installation	Z-AHK	248433
Tripping signal switch for subsequent installation	Z-NHK	248434
Shunt trip release	Z-ASA/..	248286, 248287
Tripping module	Z-KAM	248294

Technical Data

		eRBM-ME, 1+N-pole, 1MU
Electrical		
Design according to		BS/EN 61009
Current test marks as printed onto the device		
Number of poles		1+N-pole, pole switched, N led through (solid neutral)
Rated voltage	U_n	240 VAC
Rated frequency		50 Hz
Rated current	I_n	6 - 45 A
Rated tripping current	$I_{\Delta n}$	10, 30, 100, 300 mA
Sensitivity		AC
Tripping Characteristic RCD component		
Tripping line voltage dependent		instantaneous
Peak withstand current		250 A (8/20 μ s)
Rated non-tripping current	$I_{\Delta no}$	0.5 $I_{\Delta n}$
Voltage range for protective function		184 - 264 V~
Tripping Characteristic MCB component		
Conventional non-tripping current		1.13 I_n
Conventional tripping current		1.45 I_n
Reference temperature		30°C
Characteristic		C
Rated breaking capacity		10 kA
Selectivity class		3
Maximum back-up fuse (short-circuit)		100 A gL (>6 kA)
Endurance		
electrical components		\geq 4,000 switching operations
mechanical components		\geq 20,000 switching operations
Mechanical		
Frame size		45 mm
Device height		102.6 mm
Device width		17.7 mm (1MU)
Mounting		quick fastening with 2 lock-in positions on DIN rail IEC/EN 60715
Degree of protection, switch		IP20
Degree of protection, built-in		IP40
Upper terminals		lift terminals
Lower terminals		open-mouthed/lift terminals
Terminal protection		finger and hand touch safe, DGUV VS3, EN 50274
Terminal capacity		1 - 25 mm ²
Terminal torque		2 - 2.4 Nm
Busbar thickness		0.8 - 2 mm
Operating temperature		-25°C to +40°C
Storage- and transport temperature		-35°C to +60°C
Resistance to climatic conditions		25-55°C/90-95% relative humidity according to IEC 60068-2

Connection diagram

1+N-pole

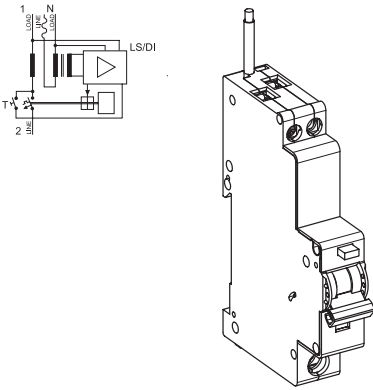

Dimensions (mm)

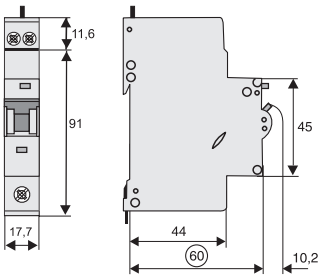

SG07911



Description

- Innovative, high-quality residual current device / miniature circuit breaker combination, line voltage-dependent
- Design width of one module unit only
- Specific for applications in the BS-distribution systems, permanently connected neutral conductors
- Contact position indicator red - green
- Comprehensive range of accessories can be mounted subsequently
- Guide for secure terminal connection
- Wide variety of rated tripping currents
- Rated currents up to 45 A
- Tripping characteristics B, C, D
- Rated breaking capacity 10 kA

$I_n/I_{\Delta n}$ (A)	Type Designation	Article No.	Units per package
---------------------------	---------------------	-------------	----------------------

Type A

10 kA, 1+N-pole

Conditionally surge current-proof 250 A, sensitive to residual pulsating DC, type A

SG07911



Characteristic B

6/0.01	eRBM-6/1/B/001-A-AU	151445	1/30
8/0.01	eRBM-8/1/B/001-A-AU	151446	1/30
10/0.01	eRBM-10/1/B/001-A-AU	151447	1/30
13/0.01	eRBM-13/1/B/001-A-AU	151448	1/30
16/0.01	eRBM-16/1/B/001-A-AU	151449	1/30
20/0.01	eRBM-20/1/B/001-A-AU	151450	1/30
25/0.01	eRBM-25/1/B/001-A-AU	151451	1/30
32/0.01	eRBM-32/1/B/001-A-AU	151452	1/30
40/0.01	eRBM-40/1/B/001-A-AU	151453	1/30
45/0.01	eRBM-45/1/B/001-A-AU	151454	1/30
6/0.03	eRBM-6/1/B/003-A-AU	151455	1/30
8/0.03	eRBM-8/1/B/003-A-AU	151456	1/30
10/0.03	eRBM-10/1/B/003-A-AU	151457	1/30
13/0.03	eRBM-13/1/B/003-A-AU	151458	1/30
16/0.03	eRBM-16/1/B/003-A-AU	151459	1/30
20/0.03	eRBM-20/1/B/003-A-AU	151460	1/30
25/0.03	eRBM-25/1/B/003-A-AU	151461	1/30
32/0.03	eRBM-32/1/B/003-A-AU	151462	1/30
40/0.03	eRBM-40/1/B/003-A-AU	151463	1/30
45/0.03	eRBM-45/1/B/003-A-AU	151464	1/30
6/0.1	eRBM-6/1/B/01-A-AU	153300	1/30
8/0.1	eRBM-8/1/B/01-A-AU	153301	1/30
10/0.1	eRBM-10/1/B/01-A-AU	153302	1/30
13/0.1	eRBM-13/1/B/01-A-AU	153303	1/30
16/0.1	eRBM-16/1/B/01-A-AU	153304	1/30
20/0.1	eRBM-20/1/B/01-A-AU	153305	1/30
25/0.1	eRBM-25/1/B/01-A-AU	153306	1/30
32/0.1	eRBM-32/1/B/01-A-AU	153307	1/30
40/0.1	eRBM-40/1/B/01-A-AU	153308	1/30
45/0.1	eRBM-45/1/B/01-A-AU	153309	1/30
6/0.3	eRBM-6/1/B/03-A-AU	151465	1/30
8/0.3	eRBM-8/1/B/03-A-AU	151466	1/30
10/0.3	eRBM-10/1/B/03-A-AU	151467	1/30
13/0.3	eRBM-13/1/B/03-A-AU	151468	1/30
16/0.3	eRBM-16/1/B/03-A-AU	151469	1/30
20/0.3	eRBM-20/1/B/03-A-AU	151470	1/30
25/0.3	eRBM-25/1/B/03-A-AU	151471	1/30
32/0.3	eRBM-32/1/B/03-A-AU	151472	1/30
40/0.3	eRBM-40/1/B/03-A-AU	151473	1/30
45/0.3	eRBM-45/1/B/03-A-AU	151474	1/30

1.4

Combined RCD/MCB Devices

xPole

Electronic Combined RCD/MCB Devices eRBM-AU, 1+N-pole, 1MU

SG07911



$I_n/I_{\Delta n}$ (A)	Type Designation	Article No.	Units per package
Characteristic C			
6/0.01	eRBM-6/1/C/001-A-AU	151565	1/30
8/0.01	eRBM-8/1/C/001-A-AU	151566	1/30
10/0.01	eRBM-10/1/C/001-A-AU	151567	1/30
13/0.01	eRBM-13/1/C/001-A-AU	151568	1/30
16/0.01	eRBM-16/1/C/001-A-AU	151569	1/30
20/0.01	eRBM-20/1/C/001-A-AU	151570	1/30
25/0.01	eRBM-25/1/C/001-A-AU	151571	1/30
32/0.01	eRBM-32/1/C/001-A-AU	151572	1/30
40/0.01	eRBM-40/1/C/001-A-AU	151573	1/30
45/0.01	eRBM-45/1/C/001-A-AU	151574	1/30
6/0.03	eRBM-6/1/C/003-A-AU	151575	1/30
8/0.03	eRBM-8/1/C/003-A-AU	151576	1/30
10/0.03	eRBM-10/1/C/003-A-AU	151577	1/30
13/0.03	eRBM-13/1/C/003-A-AU	151578	1/30
16/0.03	eRBM-16/1/C/003-A-AU	151579	1/30
20/0.03	eRBM-20/1/C/003-A-AU	151580	1/30
25/0.03	eRBM-25/1/C/003-A-AU	151581	1/30
32/0.03	eRBM-32/1/C/003-A-AU	151582	1/30
40/0.03	eRBM-40/1/C/003-A-AU	151583	1/30
45/0.03	eRBM-45/1/C/003-A-AU	151584	1/30
6/0.1	eRBM-6/1/C/01-A-AU	153340	1/30
8/0.1	eRBM-8/1/C/01-A-AU	153341	1/30
10/0.1	eRBM-10/1/C/01-A-AU	153342	1/30
13/0.1	eRBM-13/1/C/01-A-AU	153343	1/30
16/0.1	eRBM-16/1/C/01-A-AU	153344	1/30
20/0.1	eRBM-20/1/C/01-A-AU	153345	1/30
25/0.1	eRBM-25/1/C/01-A-AU	153346	1/30
32/0.1	eRBM-32/1/C/01-A-AU	153347	1/30
40/0.1	eRBM-40/1/C/01-A-AU	153348	1/30
45/0.1	eRBM-45/1/C/01-A-AU	153349	1/30
6/0.3	eRBM-6/1/C/03-A-AU	151585	1/30
8/0.3	eRBM-8/1/C/03-A-AU	151586	1/30
10/0.3	eRBM-10/1/C/03-A-AU	151587	1/30
13/0.3	eRBM-13/1/C/03-A-AU	151588	1/30
16/0.3	eRBM-16/1/C/03-A-AU	151589	1/30
20/0.3	eRBM-20/1/C/03-A-AU	151590	1/30
25/0.3	eRBM-25/1/C/03-A-AU	151591	1/30
32/0.3	eRBM-32/1/C/03-A-AU	151592	1/30
40/0.3	eRBM-40/1/C/03-A-AU	151593	1/30
45/0.3	eRBM-45/1/C/03-A-AU	151594	1/30

SG07911



$I_n/I_{\Delta n}$ (A)	Type Designation	Article No.	Units per package
Characteristic D			
6/0.01	eRBM-6/1/D/001-A-AU	151649	1/30
8/0.01	eRBM-8/1/D/001-A-AU	151650	1/30
10/0.01	eRBM-10/1/D/001-A-AU	151651	1/30
13/0.01	eRBM-13/1/D/001-A-AU	151652	1/30
16/0.01	eRBM-16/1/D/001-A-AU	151653	1/30
20/0.01	eRBM-20/1/D/001-A-AU	151654	1/30
6/0.03	eRBM-6/1/D/003-A-AU	151655	1/30
8/0.03	eRBM-8/1/D/003-A-AU	151656	1/30
10/0.03	eRBM-10/1/D/003-A-AU	151657	1/30
13/0.03	eRBM-13/1/D/003-A-AU	151658	1/30
16/0.03	eRBM-16/1/D/003-A-AU	151659	1/30
20/0.03	eRBM-20/1/D/003-A-AU	151660	1/30
6/0.1	eRBM-6/1/D/01-A-AU	153368	1/30
8/0.1	eRBM-8/1/D/01-A-AU	153369	1/30
10/0.1	eRBM-10/1/D/01-A-AU	153370	1/30
13/0.1	eRBM-13/1/D/01-A-AU	153371	1/30
16/0.1	eRBM-16/1/D/01-A-AU	153372	1/30
20/0.1	eRBM-20/1/D/01-A-AU	153373	1/30
6/0.3	eRBM-6/1/D/03-A-AU	151661	1/30
8/0.3	eRBM-8/1/D/03-A-AU	151662	1/30
10/0.3	eRBM-10/1/D/03-A-AU	151663	1/30
13/0.3	eRBM-13/1/D/03-A-AU	151664	1/30
16/0.3	eRBM-16/1/D/03-A-AU	151665	1/30
20/0.3	eRBM-20/1/D/03-A-AU	151666	1/30

SG07911



$I_n/I_{\Delta n}$ (A)	Type Designation	Article No.	Units per package
Type AC			
10 kA, 1+N-pole			
Conditionally surge current-proof 250 A, type AC			
Characteristic B			
6/0.01	eRBM-6/1/B/001-AU	151415	1/30
8/0.01	eRBM-8/1/B/001-AU	151416	1/30
10/0.01	eRBM-10/1/B/001-AU	151417	1/30
13/0.01	eRBM-13/1/B/001-AU	151418	1/30
16/0.01	eRBM-16/1/B/001-AU	151419	1/30
20/0.01	eRBM-20/1/B/001-AU	151420	1/30
25/0.01	eRBM-25/1/B/001-AU	151421	1/30
32/0.01	eRBM-32/1/B/001-AU	151422	1/30
40/0.01	eRBM-40/1/B/001-AU	151423	1/30
45/0.01	eRBM-45/1/B/001-AU	151424	1/30
6/0.03	eRBM-6/1/B/003-AU	151425	1/30
8/0.03	eRBM-8/1/B/003-AU	151426	1/30
10/0.03	eRBM-10/1/B/003-AU	151427	1/30
13/0.03	eRBM-13/1/B/003-AU	151428	1/30
16/0.03	eRBM-16/1/B/003-AU	151429	1/30
20/0.03	eRBM-20/1/B/003-AU	151430	1/30
25/0.03	eRBM-25/1/B/003-AU	151431	1/30
32/0.03	eRBM-32/1/B/003-AU	151432	1/30
40/0.03	eRBM-40/1/B/003-AU	151433	1/30
45/0.03	eRBM-45/1/B/003-AU	151434	1/30
6/0.1	eRBM-6/1/B/01-AU	153290	1/30
8/0.1	eRBM-8/1/B/01-AU	153291	1/30
10/0.1	eRBM-10/1/B/01-AU	153292	1/30
13/0.1	eRBM-13/1/B/01-AU	153293	1/30
16/0.1	eRBM-16/1/B/01-AU	153294	1/30
20/0.1	eRBM-20/1/B/01-AU	153295	1/30
25/0.1	eRBM-25/1/B/01-AU	153296	1/30
32/0.1	eRBM-32/1/B/01-AU	153297	1/30
40/0.1	eRBM-40/1/B/01-AU	153298	1/30
45/0.1	eRBM-45/1/B/01-AU	153299	1/30
6/0.3	eRBM-6/1/B/03-AU	151435	1/30
8/0.3	eRBM-8/1/B/03-AU	151436	1/30
10/0.3	eRBM-10/1/B/03-AU	151437	1/30
13/0.3	eRBM-13/1/B/03-AU	151438	1/30
16/0.3	eRBM-16/1/B/03-AU	151439	1/30
20/0.3	eRBM-20/1/B/03-AU	151440	1/30
25/0.3	eRBM-25/1/B/03-AU	151441	1/30
32/0.3	eRBM-32/1/B/03-AU	151442	1/30
40/0.3	eRBM-40/1/B/03-AU	151443	1/30
45/0.3	eRBM-45/1/B/03-AU	151444	1/30

SG07911



$I_n/I_{\Delta n}$ (A)	Type Designation	Article No.	Units per package
Characteristic C			
6/0.01	eRBM-6/1/C/001-AU	151535	1/30
8/0.01	eRBM-8/1/C/001-AU	151536	1/30
10/0.01	eRBM-10/1/C/001-AU	151537	1/30
13/0.01	eRBM-13/1/C/001-AU	151538	1/30
16/0.01	eRBM-16/1/C/001-AU	151539	1/30
20/0.01	eRBM-20/1/C/001-AU	151540	1/30
25/0.01	eRBM-25/1/C/001-AU	151541	1/30
32/0.01	eRBM-32/1/C/001-AU	151542	1/30
40/0.01	eRBM-40/1/C/001-AU	151543	1/30
45/0.01	eRBM-45/1/C/001-AU	151544	1/30
6/0.03	eRBM-6/1/C/003-AU	151545	1/30
8/0.03	eRBM-8/1/C/003-AU	151546	1/30
10/0.03	eRBM-10/1/C/003-AU	151547	1/30
13/0.03	eRBM-13/1/C/003-AU	151548	1/30
16/0.03	eRBM-16/1/C/003-AU	151549	1/30
20/0.03	eRBM-20/1/C/003-AU	151550	1/30
25/0.03	eRBM-25/1/C/003-AU	151551	1/30
32/0.03	eRBM-32/1/C/003-AU	151552	1/30
40/0.03	eRBM-40/1/C/003-AU	151553	1/30
45/0.03	eRBM-45/1/C/003-AU	151554	1/30
6/0.1	eRBM-6/1/C/01-AU	153330	1/30
8/0.1	eRBM-8/1/C/01-AU	153331	1/30
10/0.1	eRBM-10/1/C/01-AU	153332	1/30
13/0.1	eRBM-13/1/C/01-AU	153333	1/30
16/0.1	eRBM-16/1/C/01-AU	153334	1/30
20/0.1	eRBM-20/1/C/01-AU	153335	1/30
25/0.1	eRBM-25/1/C/01-AU	153336	1/30
32/0.1	eRBM-32/1/C/01-AU	153337	1/30
40/0.1	eRBM-40/1/C/01-AU	153338	1/30
45/0.1	eRBM-45/1/C/01-AU	153339	1/30
6/0.3	eRBM-6/1/C/03-AU	151555	1/30
8/0.3	eRBM-8/1/C/03-AU	151556	1/30
10/0.3	eRBM-10/1/C/03-AU	151557	1/30
13/0.3	eRBM-13/1/C/03-AU	151558	1/30
16/0.3	eRBM-16/1/C/03-AU	151559	1/30
20/0.3	eRBM-20/1/C/03-AU	151560	1/30
25/0.3	eRBM-25/1/C/03-AU	151561	1/30
32/0.3	eRBM-32/1/C/03-AU	151562	1/30
40/0.3	eRBM-40/1/C/03-AU	151563	1/30
45/0.3	eRBM-45/1/C/03-AU	151564	1/30

1.4

Combined RCD/MCB Devices

xPole

Electronic Combined RCD/MCB Devices eRBM-AU, 1+N-pole, 1MU

SG07911



$I_n/I_{\Delta n}$ (A)	Type Designation	Article No.	Units per package
Characteristic D			
6/0.01	eRBM-6/1/D/001-AU	151613	1/30
8/0.01	eRBM-8/1/D/001-AU	151614	1/30
10/0.01	eRBM-10/1/D/001-AU	151615	1/30
13/0.01	eRBM-13/1/D/001-AU	151616	1/30
16/0.01	eRBM-16/1/D/001-AU	151617	1/30
20/0.01	eRBM-20/1/D/001-AU	151618	1/30
6/0.03	eRBM-6/1/D/003-AU	151619	1/30
8/0.03	eRBM-8/1/D/003-AU	151620	1/30
10/0.03	eRBM-10/1/D/003-AU	151621	1/30
13/0.03	eRBM-13/1/D/003-AU	151622	1/30
16/0.03	eRBM-16/1/D/003-AU	151623	1/30
20/0.03	eRBM-20/1/D/003-AU	151624	1/30
6/0.1	eRBM-6/1/D/01-AU	151625	1/30
8/0.1	eRBM-8/1/D/01-AU	151626	1/30
10/0.1	eRBM-10/1/D/01-AU	151627	1/30
13/0.1	eRBM-13/1/D/01-AU	151628	1/30
16/0.1	eRBM-16/1/D/01-AU	151629	1/30
20/0.1	eRBM-20/1/D/01-AU	151630	1/30
6/0.3	eRBM-6/1/D/03-AU	153362	1/30
8/0.3	eRBM-8/1/D/03-AU	153363	1/30
10/0.3	eRBM-10/1/D/03-AU	153364	1/30
13/0.3	eRBM-13/1/D/03-AU	153365	1/30
16/0.3	eRBM-16/1/D/03-AU	153366	1/30
20/0.3	eRBM-20/1/D/03-AU	153367	1/30

Specifications | Electronic Combined RCD/MCB Devices eRBM-AU, 1+N-pole, 1MU

Description

- Electronic residual current device / miniature circuit breaker combination in only 1MU
- Tripping line voltage dependent
- Contact position indicator red - green
- Can be sealed with leads in the ON and OFF position
- Colour coded switching toggle (designating the rated current)
- Permanently connected neutral conductor (950 mm long, black)
- Special application in British-Standard-Distribution Boxes
- Can be connected to standard busbar (at the lower side)
- Comprehensive range of accessories can be mounted subsequently

Accessories:

Tripping signal switch for subsequent installation	Z-NHK	248434
Shunt trip release	Z-ASA/..	248286, 248287
Tripping module	Z-KAM	248294

Technical Data

		eRBM-AU, 1+N-pole, 1MU
Electrical		
Design according to		BS/EN 61009
Current test marks as printed onto the device		
Number of poles		1+N-pole, pole switched, N led through (solid neutral)
Rated voltage	U_n	240 VAC
Rated frequency		50 Hz
Rated current	I_n	6 - 45 A
Rated tripping current	$I_{\Delta n}$	10, 30, 100, 300 mA
Sensitivity		AC and pulsating DC
Tripping Characteristic RCD component		
Tripping line voltage dependent		instantaneous
Peak withstand current		250 A (8/20 μ s)
Rated non-tripping current	$I_{\Delta no}$	0.5 $I_{\Delta n}$
Voltage range for protective function		184 - 264 V~
Tripping Characteristic MCB component		
Conventional non-tripping current		1.13 I_n
Conventional tripping current		1.45 I_n
Reference temperature		30°C
Characteristic		B, C, D
Rated breaking capacity		10 kA
Selectivity class		3
Maximum back-up fuse (short-circuit)		100 A gL (>6 kA)
Endurance		
electrical components		$\geq 4,000$ switching operations
mechanical components		$\geq 20,000$ switching operations
Mechanical		
Frame size		45 mm
Device height		102.6 mm
Device width		17.7 mm (1MU)
Mounting		quick fastening with 2 lock-in positions on DIN rail IEC/EN 60715
Degree of protection, switch		IP20
Degree of protection, built-in		IP40
Upper terminals		lift terminals
Lower terminals		open-mouthed/lift terminals
Terminal protection		finger and hand touch safe, DGUV VS3, EN 50274
Terminal capacity		1 - 25 mm ²
Terminal torque		2 - 2.4 Nm
Busbar thickness		0.8 - 2 mm
Operating temperature		-25°C to +40°C
Storage- and transport temperature		-35°C to +60°C
Resistance to climatic conditions		25-55°C/90-95% relative humidity according to IEC 60068-2

1.4

Combined RCD/MCB Devices

xPole

Electronic Combined RCD/MCB Devices eRBM-AU, 1+N-pole, 1MU - Technical Data

Connection diagram

1+N-pole

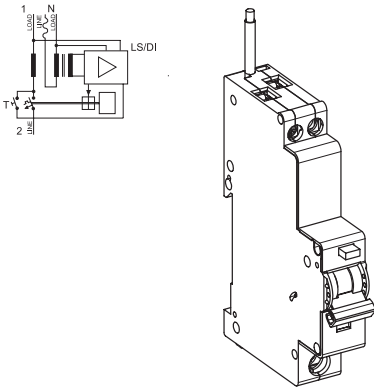

Dimensions (mm)

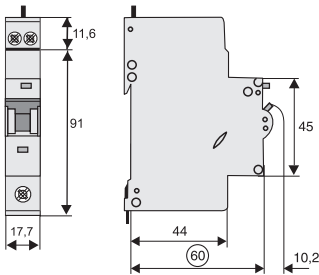

SG07911



Description

- Innovative, high-quality residual current device / miniature circuit breaker combination, line voltage-dependent
- Design width of one module unit only
- Specific for applications in the BS-distribution systems, permanently connected neutral conductors
- Contact position indicator red - green
- Comprehensive range of accessories can be mounted subsequently
- Guide for secure terminal connection
- Wide variety of rated tripping currents
- Rated currents up to 45 A
- Tripping characteristics B, C, D
- Rated breaking capacity 6 kA

SG07911



$I_n/I_{\Delta n}$ (A)	Type Designation	Article No.	Units per package
Type A			
6 kA, 1+N-pole			
Conditionally surge current-proof 250 A, sensitive to residual pulsating DC, type A			
Characteristic B			
6/0.01	eRB6-6/1/B/001-A-AU	151385	1/30
8/0.01	eRB6-8/1/B/001-A-AU	151386	1/30
10/0.01	eRB6-10/1/B/001-A-AU	151387	1/30
13/0.01	eRB6-13/1/B/001-A-AU	151388	1/30
16/0.01	eRB6-16/1/B/001-A-AU	151389	1/30
20/0.01	eRB6-20/1/B/001-A-AU	151390	1/30
25/0.01	eRB6-25/1/B/001-A-AU	151391	1/30
32/0.01	eRB6-32/1/B/001-A-AU	151392	1/30
40/0.01	eRB6-40/1/B/001-A-AU	151393	1/30
45/0.01	eRB6-45/1/B/001-A-AU	151394	1/30
6/0.03	eRB6-6/1/B/003-A-AU	151395	1/30
8/0.03	eRB6-8/1/B/003-A-AU	151396	1/30
10/0.03	eRB6-10/1/B/003-A-AU	151397	1/30
13/0.03	eRB6-13/1/B/003-A-AU	151398	1/30
16/0.03	eRB6-16/1/B/003-A-AU	151399	1/30
20/0.03	eRB6-20/1/B/003-A-AU	151400	1/30
25/0.03	eRB6-25/1/B/003-A-AU	151401	1/30
32/0.03	eRB6-32/1/B/003-A-AU	151402	1/30
40/0.03	eRB6-40/1/B/003-A-AU	151403	1/30
45/0.03	eRB6-45/1/B/003-A-AU	151404	1/30
6/0.1	eRB6-6/1/B/01-A-AU	153280	1/30
8/0.1	eRB6-8/1/B/01-A-AU	153281	1/30
10/0.1	eRB6-10/1/B/01-A-AU	153282	1/30
13/0.1	eRB6-13/1/B/01-A-AU	153283	1/30
16/0.1	eRB6-16/1/B/01-A-AU	153284	1/30
20/0.1	eRB6-20/1/B/01-A-AU	153285	1/30
25/0.1	eRB6-25/1/B/01-A-AU	153286	1/30
32/0.1	eRB6-32/1/B/01-A-AU	153287	1/30
40/0.1	eRB6-40/1/B/01-A-AU	153288	1/30
45/0.1	eRB6-45/1/B/01-A-AU	153289	1/30
6/0.3	eRB6-6/1/B/03-A-AU	151405	1/30
8/0.3	eRB6-8/1/B/03-A-AU	151406	1/30
10/0.3	eRB6-10/1/B/03-A-AU	151407	1/30
13/0.3	eRB6-13/1/B/03-A-AU	151408	1/30
16/0.3	eRB6-16/1/B/03-A-AU	151409	1/30
20/0.3	eRB6-20/1/B/03-A-AU	151410	1/30
25/0.3	eRB6-25/1/B/03-A-AU	151411	1/30
32/0.3	eRB6-32/1/B/03-A-AU	151412	1/30
40/0.3	eRB6-40/1/B/03-A-AU	151413	1/30
45/0.3	eRB6-45/1/B/03-A-AU	151414	1/30

SG07911



$I_n/I_{\Delta n}$ (A)	Type Designation	Article No.	Units per package
Characteristic C			
6/0.01	eRB6-6/1/C/001-A-AU	151505	1/30
8/0.01	eRB6-8/1/C/001-A-AU	151506	1/30
10/0.01	eRB6-10/1/C/001-A-AU	151507	1/30
13/0.01	eRB6-13/1/C/001-A-AU	151508	1/30
16/0.01	eRB6-16/1/C/001-A-AU	151509	1/30
20/0.01	eRB6-20/1/C/001-A-AU	151510	1/30
25/0.01	eRB6-25/1/C/001-A-AU	151511	1/30
32/0.01	eRB6-32/1/C/001-A-AU	151512	1/30
40/0.01	eRB6-40/1/C/001-A-AU	151513	1/30
45/0.01	eRB6-45/1/C/001-A-AU	151514	1/30
6/0.03	eRB6-6/1/C/003-A-AU	151515	1/30
8/0.03	eRB6-8/1/C/003-A-AU	151516	1/30
10/0.03	eRB6-10/1/C/003-A-AU	151517	1/30
13/0.03	eRB6-13/1/C/003-A-AU	151518	1/30
16/0.03	eRB6-16/1/C/003-A-AU	151519	1/30
20/0.03	eRB6-20/1/C/003-A-AU	151520	1/30
25/0.03	eRB6-25/1/C/003-A-AU	151521	1/30
32/0.03	eRB6-32/1/C/003-A-AU	151522	1/30
40/0.03	eRB6-40/1/C/003-A-AU	151523	1/30
45/0.03	eRB6-45/1/C/003-A-AU	151524	1/30
6/0.1	eRB6-6/1/C/01-A-AU	153320	1/30
8/0.1	eRB6-8/1/C/01-A-AU	153321	1/30
10/0.1	eRB6-10/1/C/01-A-AU	153322	1/30
13/0.1	eRB6-13/1/C/01-A-AU	153323	1/30
16/0.1	eRB6-16/1/C/01-A-AU	153324	1/30
20/0.1	eRB6-20/1/C/01-A-AU	153325	1/30
25/0.1	eRB6-25/1/C/01-A-AU	153326	1/30
32/0.1	eRB6-32/1/C/01-A-AU	153327	1/30
40/0.1	eRB6-40/1/C/01-A-AU	153328	1/30
45/0.1	eRB6-45/1/C/01-A-AU	153329	1/30
6/0.3	eRB6-6/1/C/03-A-AU	151525	1/30
8/0.3	eRB6-8/1/C/03-A-AU	151526	1/30
10/0.3	eRB6-10/1/C/03-A-AU	151527	1/30
13/0.3	eRB6-13/1/C/03-A-AU	151528	1/30
16/0.3	eRB6-16/1/C/03-A-AU	151529	1/30
20/0.3	eRB6-20/1/C/03-A-AU	151530	1/30
25/0.3	eRB6-25/1/C/03-A-AU	151531	1/30
32/0.3	eRB6-32/1/C/03-A-AU	151532	1/30
40/0.3	eRB6-40/1/C/03-A-AU	151533	1/30
45/0.3	eRB6-45/1/C/03-A-AU	151534	1/30

1.4

Combined RCD/MCB Devices

xPole

Electronic Combined RCD/MCB Devices eRB6-AU, 1+N-pole, 1MU

SG07911



$I_n/I_{\Delta n}$ (A)	Type Designation	Article No.	Units per package
Characteristic D			
6/0.01	eRB6-6/1/D/001-A-AU	151631	1/30
8/0.01	eRB6-8/1/D/001-A-AU	151632	1/30
10/0.01	eRB6-10/1/D/001-A-AU	151633	1/30
13/0.01	eRB6-13/1/D/001-A-AU	151634	1/30
16/0.01	eRB6-16/1/D/001-A-AU	151635	1/30
20/0.01	eRB6-20/1/D/001-A-AU	151636	1/30
6/0.03	eRB6-6/1/D/003-A-AU	151637	1/30
8/0.03	eRB6-8/1/D/003-A-AU	151638	1/30
10/0.03	eRB6-10/1/D/003-A-AU	151639	1/30
13/0.03	eRB6-13/1/D/003-A-AU	151640	1/30
16/0.03	eRB6-16/1/D/003-A-AU	151641	1/30
20/0.03	eRB6-20/1/D/003-A-AU	151642	1/30
6/0.1	eRB6-6/1/D/01-A-AU	153356	1/30
8/0.1	eRB6-8/1/D/01-A-AU	153357	1/30
10/0.1	eRB6-10/1/D/01-A-AU	153358	1/30
13/0.1	eRB6-13/1/D/01-A-AU	153359	1/30
16/0.1	eRB6-16/1/D/01-A-AU	153360	1/30
20/0.1	eRB6-20/1/D/01-A-AU	153361	1/30
6/0.3	eRB6-6/1/D/03-A-AU	151643	1/30
8/0.3	eRB6-8/1/D/03-A-AU	151644	1/30
10/0.3	eRB6-10/1/D/03-A-AU	151645	1/30
13/0.3	eRB6-13/1/D/03-A-AU	151646	1/30
16/0.3	eRB6-16/1/D/03-A-AU	151647	1/30
20/0.3	eRB6-20/1/D/03-A-AU	151648	1/30

$I_n/I_{\Delta n}$ (A)	Type Designation	Article No.	Units per package
---------------------------	---------------------	-------------	----------------------

Type AC

6 kA, 1+N-pole
Conditionally surge current-proof 250 A, type AC

Characteristic B

6/0.01	eRB6-6/1/B/001-AU	151245	1/30
8/0.01	eRB6-8/1/B/001-AU	151246	1/30
10/0.01	eRB6-10/1/B/001-AU	151247	1/30
13/0.01	eRB6-13/1/B/001-AU	151248	1/30
16/0.01	eRB6-16/1/B/001-AU	151249	1/30
20/0.01	eRB6-20/1/B/001-AU	151360	1/30
25/0.01	eRB6-25/1/B/001-AU	151361	1/30
32/0.01	eRB6-32/1/B/001-AU	151362	1/30
40/0.01	eRB6-40/1/B/001-AU	151363	1/30
45/0.01	eRB6-45/1/B/001-AU	151364	1/30
6/0.03	eRB6-6/1/B/003-AU	151365	1/30
8/0.03	eRB6-8/1/B/003-AU	151366	1/30
10/0.03	eRB6-10/1/B/003-AU	151367	1/30
13/0.03	eRB6-13/1/B/003-AU	151368	1/30
16/0.03	eRB6-16/1/B/003-AU	151369	1/30
20/0.03	eRB6-20/1/B/003-AU	151370	1/30
25/0.03	eRB6-25/1/B/003-AU	151371	1/30
32/0.03	eRB6-32/1/B/003-AU	151372	1/30
40/0.03	eRB6-40/1/B/003-AU	151373	1/30
45/0.03	eRB6-45/1/B/003-AU	151374	1/30
6/0.1	eRB6-6/1/B/01-AU	153270	1/30
8/0.1	eRB6-8/1/B/01-AU	153271	1/30
10/0.1	eRB6-10/1/B/01-AU	153272	1/30
13/0.1	eRB6-13/1/B/01-AU	153273	1/30
16/0.1	eRB6-16/1/B/01-AU	153274	1/30
20/0.1	eRB6-20/1/B/01-AU	153275	1/30
25/0.1	eRB6-25/1/B/01-AU	153276	1/30
32/0.1	eRB6-32/1/B/01-AU	153277	1/30
40/0.1	eRB6-40/1/B/01-AU	153278	1/30
45/0.1	eRB6-45/1/B/01-AU	153279	1/30
6/0.3	eRB6-6/1/B/03-AU	151375	1/30
8/0.3	eRB6-8/1/B/03-AU	151376	1/30
10/0.3	eRB6-10/1/B/03-AU	151377	1/30
13/0.3	eRB6-13/1/B/03-AU	151378	1/30
16/0.3	eRB6-16/1/B/03-AU	151379	1/30
20/0.3	eRB6-20/1/B/03-AU	151380	1/30
25/0.3	eRB6-25/1/B/03-AU	151381	1/30
32/0.3	eRB6-32/1/B/03-AU	151382	1/30
40/0.3	eRB6-40/1/B/03-AU	151383	1/30
45/0.3	eRB6-45/1/B/03-AU	151384	1/30

SG07911



1.4

Combined RCD/MCB Devices

xPole

Electronic Combined RCD/MCB Devices eRB6-AU, 1+N-pole, 1MU

SG07911



$I_n/I_{\Delta n}$ (A)	Type Designation	Article No.	Units per package
Characteristic C			
6/0.01	eRB6-6/1/C/001-AU	151475	1/30
8/0.01	eRB6-8/1/C/001-AU	151476	1/30
10/0.01	eRB6-10/1/C/001-AU	151477	1/30
13/0.01	eRB6-13/1/C/001-AU	151478	1/30
16/0.01	eRB6-16/1/C/001-AU	151479	1/30
20/0.01	eRB6-20/1/C/001-AU	151480	1/30
25/0.01	eRB6-25/1/C/001-AU	151481	1/30
32/0.01	eRB6-32/1/C/001-AU	151482	1/30
40/0.01	eRB6-40/1/C/001-AU	151483	1/30
45/0.01	eRB6-45/1/C/001-AU	151484	1/30
6/0.03	eRB6-6/1/C/003-AU	151485	1/30
8/0.03	eRB6-8/1/C/003-AU	151486	1/30
10/0.03	eRB6-10/1/C/003-AU	151487	1/30
13/0.03	eRB6-13/1/C/003-AU	151488	1/30
16/0.03	eRB6-16/1/C/003-AU	151489	1/30
20/0.03	eRB6-20/1/C/003-AU	151490	1/30
25/0.03	eRB6-25/1/C/003-AU	151491	1/30
32/0.03	eRB6-32/1/C/003-AU	151492	1/30
40/0.03	eRB6-40/1/C/003-AU	151493	1/30
45/0.03	eRB6-45/1/C/003-AU	151494	1/30
6/0.1	eRB6-6/1/C/01-AU	153310	1/30
8/0.1	eRB6-8/1/C/01-AU	153311	1/30
10/0.1	eRB6-10/1/C/01-AU	153312	1/30
13/0.1	eRB6-13/1/C/01-AU	153313	1/30
16/0.1	eRB6-16/1/C/01-AU	153314	1/30
20/0.1	eRB6-20/1/C/01-AU	153315	1/30
25/0.1	eRB6-25/1/C/01-AU	153316	1/30
32/0.1	eRB6-32/1/C/01-AU	153317	1/30
40/0.1	eRB6-40/1/C/01-AU	153318	1/30
45/0.1	eRB6-45/1/C/01-AU	153319	1/30
6/0.3	eRB6-6/1/C/03-AU	151495	1/30
8/0.3	eRB6-8/1/C/03-AU	151496	1/30
10/0.3	eRB6-10/1/C/03-AU	151497	1/30
13/0.3	eRB6-13/1/C/03-AU	151498	1/30
16/0.3	eRB6-16/1/C/03-AU	151499	1/30
20/0.3	eRB6-20/1/C/03-AU	151500	1/30
25/0.3	eRB6-25/1/C/03-AU	151501	1/30
32/0.3	eRB6-32/1/C/03-AU	151502	1/30
40/0.3	eRB6-40/1/C/03-AU	151503	1/30
45/0.3	eRB6-45/1/C/03-AU	151504	1/30

SG07911



$I_n/I_{\Delta n}$ (A)	Type Designation	Article No.	Units per package
Characteristic D			
6/0.01	eRB6-6/1/D/001-AU	151595	1/30
8/0.01	eRB6-8/1/D/001-AU	151596	1/30
10/0.01	eRB6-10/1/D/001-AU	151597	1/30
13/0.01	eRB6-13/1/D/001-AU	151598	1/30
16/0.01	eRB6-16/1/D/001-AU	151599	1/30
20/0.01	eRB6-20/1/D/001-AU	151600	1/30
6/0.03	eRB6-6/1/D/003-AU	151601	1/30
8/0.03	eRB6-8/1/D/003-AU	151602	1/30
10/0.03	eRB6-10/1/D/003-AU	151603	1/30
13/0.03	eRB6-13/1/D/003-AU	151604	1/30
16/0.03	eRB6-16/1/D/003-AU	151605	1/30
20/0.03	eRB6-20/1/D/003-AU	151606	1/30
6/0.1	eRB6-6/1/D/01-AU	153350	1/30
8/0.1	eRB6-8/1/D/01-AU	153351	1/30
10/0.1	eRB6-10/1/D/01-AU	153352	1/30
13/0.1	eRB6-13/1/D/01-AU	153353	1/30
16/0.1	eRB6-16/1/D/01-AU	153354	1/30
20/0.1	eRB6-20/1/D/01-AU	153355	1/30
6/0.3	eRB6-6/1/D/03-AU	151607	1/30
8/0.3	eRB6-8/1/D/03-AU	151608	1/30
10/0.3	eRB6-10/1/D/03-AU	151609	1/30
13/0.3	eRB6-13/1/D/03-AU	151610	1/30
16/0.3	eRB6-16/1/D/03-AU	151611	1/30
20/0.3	eRB6-20/1/D/03-AU	151612	1/30

Specifications | Electronic Combined RCD/MCB Devices eRB6-AU, 1+N-pole, 1MU

Description

- Electronic residual current device / miniature circuit breaker combination in only 1MU
- Tripping line voltage dependent
- Contact position indicator red - green
- Can be sealed with leads in the ON and OFF position
- Colour coded switching toggle (designating the rated current)
- Permanently connected neutral conductor (950 mm long, black)
- Special application in British-Standard-Distribution Boxes
- Can be connected to standard busbar (at the lower side)
- Comprehensive range of accessories can be mounted subsequently

Accessories:

Tripping signal switch for subsequent installation	Z-NHK	248434
Shunt trip release	Z-ASA/..	248286, 248287
Tripping module	Z-KAM	248294

Technical Data

		eRB6-AU, 1+N-pole, 1MU
Electrical		
Design according to		BS/EN 61009
Current test marks as printed onto the device		
Number of poles		1+N-pole, pole switched, N led through (solid neutral)
Rated voltage	U_n	240 VAC
Rated frequency		50 Hz
Rated current	I_n	6 - 45 A
Rated tripping current	$I_{\Delta n}$	10, 30, 100, 300 mA
Sensitivity		AC and pulsating DC
Tripping Characteristic RCD component		
Tripping line voltage dependent		instantaneous
Peak withstand current		250 A (8/20 μ s)
Rated non-tripping current	$I_{\Delta no}$	0.5 $I_{\Delta n}$
Voltage range for protective function		184 - 264 V~
Tripping Characteristic MCB component		
Conventional non-tripping current		1.13 I_n
Conventional tripping current		1.45 I_n
Reference temperature		30°C
Characteristic		B, C, D
Rated breaking capacity		6 kA
Selectivity class		3
Maximum back-up fuse (short-circuit)		100 A gL (>6 kA)
Endurance		
electrical components		$\geq 4,000$ switching operations
mechanical components		$\geq 20,000$ switching operations
Mechanical		
Frame size		45 mm
Device height		102.6 mm
Device width		17.7 mm (1MU)
Mounting		quick fastening with 2 lock-in positions on DIN rail IEC/EN 60715
Degree of protection, switch		IP20
Degree of protection, built-in		IP40
Upper terminals		lift terminals
Lower terminals		open-mouthed/lift terminals
Terminal protection		finger and hand touch safe, DGUV VS3, EN 50274
Terminal capacity		1 - 25 mm ²
Terminal torque		2 - 2.4 Nm
Busbar thickness		0.8 - 2 mm
Operating temperature		-25°C to +40°C
Storage- and transport temperature		-35°C to +60°C
Resistance to climatic conditions		25-55°C/90-95% relative humidity according to IEC 60068-2

Connection diagram

1+N-pole

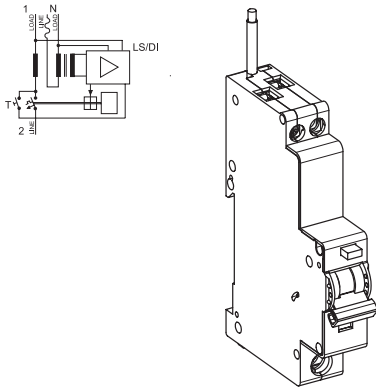

Dimensions (mm)

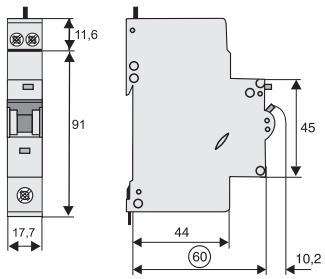

SG14011



Description

- High-quality residual current device / miniature circuit breaker combination, line voltage-independent
- Increased protection in applications with 1-phase frequency converter due to the detection of mixed frequencies (type F)
- Reduction of nuisance tripping (type F or G/A) thanks to
 - time delayed tripping
 - increased current withstand capability > 3 kA
- Higher load rating with DC residual currents up to 10 mA (type F)
- Contact position indicator red - green
- Fault current tripping indicator white - blue
- Guide for secure terminal connection
- 3-position DIN rail clip, permits removal from existing busbar system
- Comprehensive range of accessories can be mounted subsequently
- Wide variety of rated tripping currents
- Rated currents 6 A up to 20 A
- Tripping characteristics B, C
- Rated breaking capacity 10 kA

$I_n/I_{\Delta n}$
(A)

Type
Designation

Article No.

Units per
package

Type F

10 kA, 2-pole

Sensitive to residual pulsating DC, surge current proof 3000 A, type F

SG14011



Characteristic B

$I_n/I_{\Delta n}$ (A)	Type Designation	Article No.	Units per package
10/0.03	PKPM2-10/2/B/003-F	196942	1/60
13/0.03	PKPM2-13/2/B/003-F	196943	1/60
15/0.03	PKPM2-15/2/B/003-F-OL	196944	1/60
16/0.03	PKPM2-16/2/B/003-F	196945	1/60
20/0.03	PKPM2-20/2/B/003-F	196946	1/60
20/0.03	PKPM2-20/2/B/003-F-OL	196947	1/60

SG14011



Characteristic C

$I_n/I_{\Delta n}$ (A)	Type Designation	Article No.	Units per package
6/0.03	PKPM2-6/2/C/003-F	196931	1/60
10/0.03	PKPM2-10/2/C/003-F	196932	1/60
13/0.03	PKPM2-13/2/C/003-F	196933	1/60
15/0.03	PKPM2-15/2/C/003-F-OL	196934	1/60
16/0.03	PKPM2-16/2/C/003-F	196935	1/60
20/0.03	PKPM2-20/2/C/003-F	196936	1/60
20/0.03	PKPM2-20/2/C/003-F-OL	196937	1/60

Type G/A

10 kA, 2-pole

Sensitive to residual pulsating DC, surge current proof 3000 A, type G/A

SG14011



Characteristic B

$I_n/I_{\Delta n}$ (A)	Type Designation	Article No.	Units per package
10/0.03	PKPM2-10/2/B/003-G/A	196922	1/60
13/0.03	PKPM2-13/2/B/003-G/A	196923	1/60
15/0.03	PKPM2-15/2/B/003-G/A-OL	196924	1/60
16/0.03	PKPM2-16/2/B/003-G/A	196925	1/60
20/0.03	PKPM2-20/2/B/003-G/A	196926	1/60
20/0.03	PKPM2-20/2/B/003-G/A-OL	196927	1/60

SG14011



Characteristic C

$I_n/I_{\Delta n}$ (A)	Type Designation	Article No.	Units per package
6/0.03	PKPM2-6/2/C/003-G/A	196911	1/60
10/0.03	PKPM2-10/2/C/003-G/A	196912	1/60
13/0.03	PKPM2-13/2/C/003-G/A	196913	1/60
15/0.03	PKPM2-15/2/C/003-G/A-OL	196914	1/60
16/0.03	PKPM2-16/2/C/003-G/A	196915	1/60
20/0.03	PKPM2-20/2/C/003-G/A	196916	1/60
20/0.03	PKPM2-20/2/C/003-G/A-OL	196917	1/60

$I_n/I_{\Delta n}$ (A)	Type Designation	Article No.	Units per package
---------------------------	---------------------	-------------	----------------------

Type A

10 kA, 2-pole

Conditionally surge current-proof 250 A, sensitive to residual pulsating DC, type A

SG14011



Characteristic B

10/0.03	PKPM2-10/2/B/003-A	108105	1/60
13/0.03	PKPM2-13/2/B/003-A	108106	1/60
16/0.03	PKPM2-16/2/B/003-A	108107	1/60
20/0.03	PKPM2-20/2/B/003-A	108108	1/60
10/0.1	PKPM2-10/2/B/01-A	108113	1/60
13/0.1	PKPM2-13/2/B/01-A	108114	1/60
16/0.1	PKPM2-16/2/B/01-A	108115	1/60
20/0.1	PKPM2-20/2/B/01-A	108116	1/60
10/0.3	PKPM2-10/2/B/03-A	111634	1/60
13/0.3	PKPM2-13/2/B/03-A	111635	1/60
16/0.3	PKPM2-16/2/B/03-A	111636	1/60
20/0.3	PKPM2-20/2/B/03-A	111637	1/60

SG14011



Characteristic C

6/0.03	PKPM2-6/2/C/003-A	111638	1/60
10/0.03	PKPM2-10/2/C/003-A	108109	1/60
13/0.03	PKPM2-13/2/C/003-A	108110	1/60
16/0.03	PKPM2-16/2/C/003-A	108111	1/60
20/0.03	PKPM2-20/2/C/003-A	108112	1/60
10/0.1	PKPM2-10/2/C/01-A	108117	1/60
13/0.1	PKPM2-13/2/C/01-A	108118	1/60
16/0.1	PKPM2-16/2/C/01-A	108119	1/60
20/0.1	PKPM2-20/2/C/01-A	108120	1/60
6/0.3	PKPM2-6/2/C/03-A	111639	1/60
10/0.3	PKPM2-10/2/C/03-A	111640	1/60
13/0.3	PKPM2-13/2/C/03-A	111641	1/60
16/0.3	PKPM2-16/2/C/03-A	111642	1/60
20/0.3	PKPM2-20/2/C/03-A	111643	1/60

Type AC

10 kA, 2-pole

Conditionally surge current-proof 250 A, type AC

SG14011



Characteristic B

10/0.03	PKPM2-10/2/B/003	111597	1/60
13/0.03	PKPM2-13/2/B/003	111598	1/60
16/0.03	PKPM2-16/2/B/003	111599	1/60
20/0.03	PKPM2-20/2/B/003	111600	1/60
10/0.3	PKPM2-10/2/B/03	111602	1/60
13/0.3	PKPM2-13/2/B/03	111603	1/60
16/0.3	PKPM2-16/2/B/03	111604	1/60
20/0.3	PKPM2-20/2/B/03	111605	1/60

SG14011



Characteristic C

6/0.03	PKPM2-6/2/C/003	111622	1/60
10/0.03	PKPM2-10/2/C/003	111623	1/60
13/0.03	PKPM2-13/2/C/003	111624	1/60
16/0.03	PKPM2-16/2/C/003	111625	1/60
20/0.03	PKPM2-20/2/C/003	111626	1/60
6/0.3	PKPM2-6/2/C/03	111627	1/60
10/0.3	PKPM2-10/2/C/03	111628	1/60
13/0.3	PKPM2-13/2/C/03	111629	1/60
16/0.3	PKPM2-16/2/C/03	111630	1/60
20/0.3	PKPM2-20/2/C/03	111631	1/60

SG13811



Description

- High-quality residual current device / miniature circuit breaker combination, line voltage-independent
- Increased protection in applications with 1-phase frequency converter due to the detection of mixed frequencies (type F)
- Reduction of nuisance tripping (type F or G/A) thanks to
 - time delayed tripping
 - increased current withstand capability > 3 kA
- Higher load rating with DC residual currents up to 10 mA (type F)
- Contact position indicator red - green
- Fault current tripping indicator white - blue
- Guide for secure terminal connection
- 3-position DIN rail clip, permits removal from existing busbar system
- Comprehensive range of accessories can be mounted subsequently
- Wide variety of rated tripping currents
- Rated currents up to 40 A
- Tripping characteristics B, C
- Rated breaking capacity 6 kA

$I_n/I_{\Delta n}$ (A)	Type Designation	Article No.	Units per package
---------------------------	---------------------	-------------	----------------------

Type F

6 kA, 2-pole

Sensitive to residual pulsating DC, surge current proof 3000 A, type F

Characteristic B

25/0.03	PKP62-25/2/B/003-F	196948	1/60
32/0.03	PKP62-32/2/B/003-F	196949	1/60
40/0.03	PKP62-40/2/B/003-F	196950	1/60

SG13811



Characteristic C

25/0.03	PKP62-25/2/C/003-F	196938	1/60
32/0.03	PKP62-32/2/C/003-F	196939	1/60
40/0.03	PKP62-40/2/C/003-F	196940	1/60

SG13811



Type GA

6 kA, 2-pole

Sensitive to residual pulsating DC, surge current proof 3000 A, type G/A

Characteristic B

25/0.03	PKP62-25/2/B/003-G/A	196928	1/60
32/0.03	PKP62-32/2/B/003-G/A	196929	1/60
40/0.03	PKP62-40/2/B/003-G/A	196930	1/60

SG13811



Characteristic C

25/0.03	PKP62-25/2/C/003-G/A	196918	1/60
32/0.03	PKP62-32/2/C/003-G/A	196919	1/60
40/0.03	PKP62-40/2/C/003-G/A	196920	1/60

SG13811



$I_n/I_{\Delta n}$
(A)

Type
Designation

Article No.

Units per
package

Type A

6 kA, 2-pole

Conditionally surge current-proof 250 A, sensitive to residual pulsating DC, type A

SG13811



Characteristic B

25/0.03	PKP62-25/2/B/003-A	113889	1/60
32/0.03	PKP62-32/2/B/003-A	113940	1/60
40/0.03	PKP62-40/2/B/003-A	113941	1/60
25/0.01	PKP62-25/2/B/01-A	113945	1/60
32/0.01	PKP62-32/2/B/01-A	113946	1/60
40/0.01	PKP62-40/2/B/01-A	113947	1/60

SG13811



Characteristic C

25/0.03	PKP62-25/2/C/003-A	113942	1/60
32/0.03	PKP62-32/2/C/003-A	113943	1/60
40/0.03	PKP62-40/2/C/003-A	113944	1/60
25/0.01	PKP62-25/2/C/01-A	113948	1/60
32/0.01	PKP62-32/2/C/01-A	113949	1/60
40/0.01	PKP62-40/2/C/01-A	113950	1/60

Type AC

6 kA, 2-pole

Conditionally surge current-proof 250 A, type AC

SG13811



Characteristic B

10/0.03	PKP62-10/2/B/003	111589	1/60
13/0.03	PKP62-13/2/B/003	111590	1/60
16/0.03	PKP62-16/2/B/003	111591	1/60
20/0.03	PKP62-20/2/B/003	111592	1/60
25/0.03	PKP62-25/2/B/003	111593	1/60
32/0.03	PKP62-32/2/B/003	111594	1/60
40/0.03	PKP62-40/2/B/003	111595	1/60

SG13811



Characteristic C

6/0.03	PKP62-6/2/C/003	111614	1/60
10/0.03	PKP62-10/2/C/003	111615	1/60
13/0.03	PKP62-13/2/C/003	111616	1/60
16/0.03	PKP62-16/2/C/003	111617	1/60
20/0.03	PKP62-20/2/C/003	111618	1/60
25/0.03	PKP62-25/2/C/003	111619	1/60
32/0.03	PKP62-32/2/C/003	111620	1/60
40/0.03	PKP62-40/2/C/003	111621	1/60

SG69511

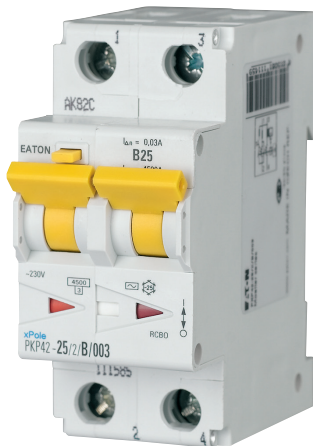

Description

- High-quality residual current device / miniature circuit breaker combination, line voltage-independent
- Contact position indicator red - green
- Fault current tripping indicator white - blue
- Guide for secure terminal connection
- 3-position DIN rail clip, permits removal from existing busbar system
- Comprehensive range of accessories can be mounted subsequently
- Wide variety of rated tripping currents
- Rated currents up to 40 A
- Tripping characteristics B, C
- Rated breaking capacity 4.5 kA

$I_n/I_{\Delta n}$ (A)	Type Designation	Article No.	Units per package
---------------------------	---------------------	-------------	----------------------

Type AC

4.5 kA, 2-pole
Conditionally surge current-proof 250 A, type AC

SG69511



Characteristic B

10/0.03	PKP42-10/2/B/003	111581	1/60
13/0.03	PKP42-13/2/B/003	111582	1/60
16/0.03	PKP42-16/2/B/003	111583	1/60
20/0.03	PKP42-20/2/B/003	111584	1/60
25/0.03	PKP42-25/2/B/003	111585	1/60
32/0.03	PKP42-32/2/B/003	111586	1/60
40/0.03	PKP42-40/2/B/003	111587	1/60

SG69511



Characteristic C

6/0.03	PKP42-6/2/C/003	111606	1/60
10/0.03	PKP42-10/2/C/003	111607	1/60
13/0.03	PKP42-13/2/C/003	111608	1/60
16/0.03	PKP42-16/2/C/003	111609	1/60
20/0.03	PKP42-20/2/C/003	111610	1/60
25/0.03	PKP42-25/2/C/003	111611	1/60
32/0.03	PKP42-32/2/C/003	111612	1/60
40/0.03	PKP42-40/2/C/003	111613	1/60

Specifications | Combined RCD/MCB Devices PKP.2, 2-pole

Description

- Combined RCD/MCB Devices
- Line voltage-independent tripping
- Compatible with standard busbar
- Twin-purpose terminal (lift/open-mouthed) above and below
- Busbar positioning optionally above or below
- Free terminal space despite installed busbar
- Guide for secure terminal connection
- Switching toggle (MCB component) in colour designating the rated current
- Contact position indicator red - green
- Fault current tripping indicator white - blue
- Comprehensive range of accessories can be mounted subsequently
- The test key "T" must be pressed every 6 month. The system operator must be informed of this obligation and his responsibility in a way that can be proven (self-adhesive RCD-label enclosed). The test interval of 6 month is valid for residential and similar applications. Under all other conditions (e.g. damply or dusty environments), it's recommended to test in shorter intervals (e.g. monthly).
- Pressing the test key "T" serves the only purpose of function testing the residual current device (RCD). This test does not make earthing resistance measurement (R_E), or proper checking of the earth conductor condition redundant, which must be performed separately.
- **Type -A:** Protects against special forms of residual pulsating DC which have not been smoothed.
- **Type -F:** Sensitive to pulsating DC residual current and detection of multi-frequency residual currents up to 1 kHz
 - Increased protection due to the detection of mixed frequencies
 - Higher load rating with DC residual currents up to 10 mA
 - Reduction of nuisance tripping thanks to time delayed tripping and increased current withstand capability of 3 kA
 Recommended for washing machines, dish washers, or motor applications with single-phase drives
- **Type -G/A:** High reliability against unwanted tripping. Suitable for any circuit where personal injury or damage to property may occur in case of unwanted tripping. Additionally protects against special forms of residual pulsating DC which have not been smoothed.
- **OL types:** Specifically designed to fulfill the tripping characteristic requirements of I2 \leq Iz in the Norwegian electrotechnical standard NEK 400-8-823. 10:28.

Accessories:

Tripping signal switch for subsequent installation	ZP-IHK	286052
Shunt trip release	ZP-ASA/..	248438, 248439

Technical Data

		PKP.2, 2-pole
Electrical		
Design according to		IEC/EN 61009
Current test marks as printed onto the device		
Line voltage-independent tripping		instantaneous surge current proof 250 A (8/20 μ s) surge current proof 3 kA (F, -G/A, -G/A-OL) (8/20 μ s)
Rated voltage	U_e	230 V AC; 50 Hz
Operational voltage range		196-253 V
Rated tripping current	$I_{\Delta n}$	30, 100, 300 mA
Rated non-tripping current	$I_{\Delta no}$	0.5 $I_{\Delta n}$
Sensitivity		AC and pulsating DC, Type F
Selectivity class		3
Rated breaking capacity	I_{cn}	
PKPM2		10 kA
PKP62		6 kA
PKP42		4.5 kA
Rated current		6 - 40 A
Rated impulse withstand voltage	U_{imp}	4 kV (1.2/50 μ s)
Characteristic		B, C
Maximum back-up fuse (short-circuit)		100 A gL (>10 kA)
Endurance		
electrical components		\geq 4,000 switching operations
mechanical components		\geq 20,000 switching operations
Mechanical		
Frame size		45 mm
Device height		80 mm
Device width		35 mm (2 MU)
Mounting		3-position DIN rail clip, permits removal from existing busbar system
Degree of protection, switch		IP20
Degree of protection, built-in		IP40
Upper and lower terminals		open-mouthed/lift terminals
Terminal protection		finger and hand touch safe, DGUV VS3, EN 50274
Terminal capacity		1 - 25 mm ²
Terminal torque		2 - 2.4 Nm
Busbar thickness		0.8 - 2 mm
Operating temperature		-25°C to +40°C
Storage- and transport temperature		-35°C to +60°C
Resistance to climatic conditions		according to IEC/EN 61009

Connection diagram

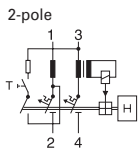

Dimensions (mm)

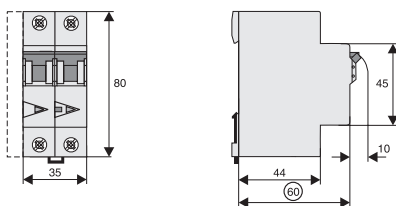

PKPM2: Influence of ambient temperature on load carrying capacity

- Values = max. allowed current in Ampere at the specific temperature
- Temperature factor (%/K) = 0.5

I_n [A]	Ambient temperature / °C									
	-40	-30	-25	-20	-10	0	10	20	30	40
6	8.1	7.8	7.7	7.5	7.2	6.9	6.6	6.3	6.0	5.7
10	13.5	13.0	12.8	12.5	12.0	11.5	11.0	10.5	10.0	9.5
13	17.6	16.9	16.6	16.3	15.6	15.0	14.3	13.7	13.0	12.4
16	21.6	20.8	20.4	20.0	19.2	18.4	17.6	16.8	16.0	15.2
20	27.0	26.0	25.5	25.0	24.0	23.0	22.0	21.0	20.0	19.0

PKP62, PKP42: Influence of ambient temperature on load carrying capacity

- Values = max. allowed current in Ampere at the specific temperature
- Temperature factor (%/K) = 0.5

I_n [A]	Ambient temperature / °C									
	-40	-30	-25	-20	-10	0	10	20	30	40
6	8.1	7.8	7.7	7.5	7.2	6.9	6.6	6.3	6.0	5.7
10	13.5	13.0	12.8	12.5	12.0	11.5	11.0	10.5	10.0	9.5
13	17.6	16.9	16.6	16.3	15.6	15.0	14.3	13.7	13.0	12.4
16	21.6	20.8	20.4	20.0	19.2	18.4	17.6	16.8	16.0	15.2
20	27.0	26.0	25.5	25.0	24.0	23.0	22.0	21.0	20.0	19.0
25	33.8	32.5	31.9	31.3	30.0	28.8	27.5	26.3	25.0	23.8
32	43.2	41.6	40.8	40.0	38.4	36.8	35.2	33.6	32.0	30.4
40	54.0	52.0	51.0	50.0	48.0	46.0	44.0	42.0	40.0	38.0

Tripping Characteristic PKP.2, Characteristics B and C

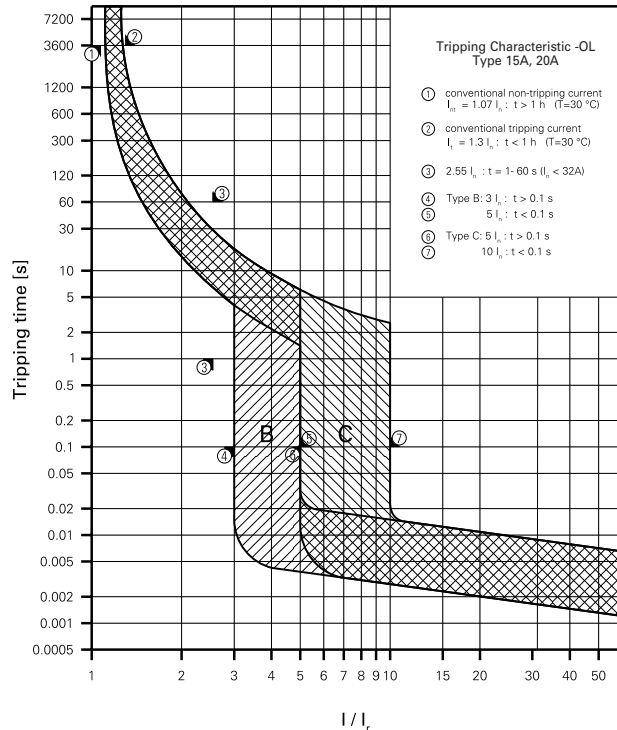
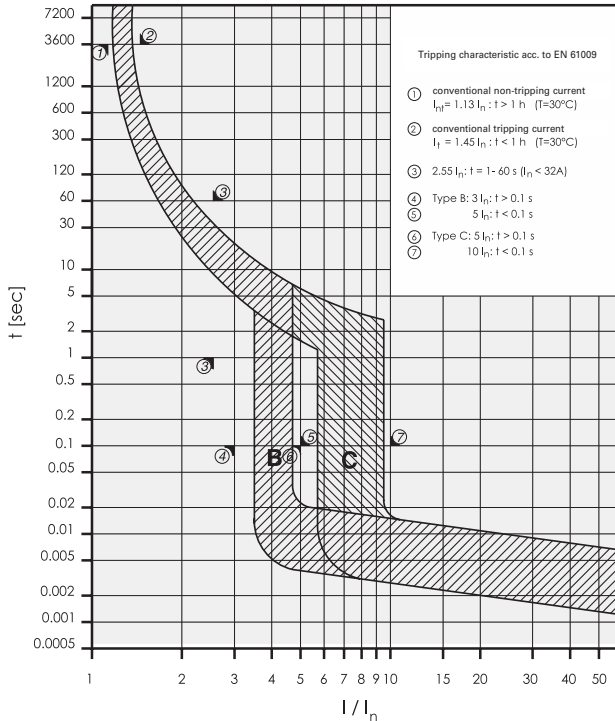

Short-circuit Selectivity PKPM2 towards Neozed¹⁾ / Diazed²⁾ / NH00³⁾

Short-circuit currents in kA, rated currents of fuses in A

Short-circuit selectivity **PKPM2** towards **Neozed** ¹⁾

PKPM2 Neozed ¹⁾	
I _n [A]	16 20 25 32 35 40 50 63 80 100
B10	<0.5 0.5 0.9 2 2.3 3.7 8 10 10 10
B13	<0.5 0.5 0.8 1.7 1.9 3 6 10 10 10
B16	0.5 0.7 1.5 1.7 2.4 4.4 6.8 10 10
B20	0.7 1.4 1.5 2.2 3.9 6 9.2 10
C10	<0.5 0.5 0.8 1.7 1.9 3 6.1 10 10 10
C13	<0.5 0.5 0.7 1.6 1.8 2.8 5.5 9.5 10 10
C16	<0.5 0.7 1.3 1.5 2.2 4 6.2 10 10
C20	0.6 1.3 1.4 2.1 3.7 5.6 8.5 10

Short-circuit selectivity **PKPM2** towards **Diazed** ²⁾

PKPM2 Diazed ²⁾	
I _n [A]	16 20 25 32 35 50 63 80 100
B10	<0.5 0.5 0.9 1.8 2.9 5.6 10 10 10
B13	<0.5 0.5 0.8 1.5 2.4 4.5 10 10 10
B16	0.5 0.8 1.3 2 3.4 8 10 10
B20	0.7 1.3 1.9 3.1 7.1 10 10
C10	<0.5 0.5 0.8 1.5 2.4 4.4 10 10 10
C13	<0.5 0.5 0.8 1.4 2.3 4.2 10 10 10
C16	<0.5 0.7 1.2 1.9 3.2 7.6 10 10
C20	0.7 1.2 1.8 2.9 6.5 9.7 10

Short-circuit selectivity **PKPM2** towards **NH00** ³⁾

PKPM2 NH00 ³⁾	
I _n [A]	16 20 25 32 35 40 50 63 80 100 125 160
B10	<0.5 <0.5 0.8 1.5 2.3 3.2 5.7 9.1 10 10 10 10
B13	<0.5 <0.5 0.8 1.3 1.9 2.7 4.4 6.5 10 10 10 10
B16	<0.5 0.7 1.1 1.6 2.2 3.4 4.8 8 10 10 10
B20	0.6 1 1.4 2 3.1 4.3 7 10 10 10
C10	<0.5 <0.5 0.7 1.3 1.9 2.7 4.5 6.9 10 10 10 10
C13	<0.5 <0.5 0.7 1.2 1.8 2.5 4.1 6.1 10 10 10 10
C16	<0.5 0.6 1 1.5 2 3.1 4.4 7.5 10 10 10
C20	0.6 0.9 1.4 1.9 2.9 4.1 6.5 10 10 10

Darker areas: no selectivity

- ¹⁾ SIEMENS Type 5SE2; Size: D01, D02, D03; Operating class gG; Rated voltage: AC 400 V/DC 250 V
- ²⁾ SIEMENS Type 5SB2, 5SB4, 5SC2; Size: DII, DIII, DIV; Operating class gG; Rated voltage: AC 500 V/DC 500 V
- ³⁾ SIEMENS Type 3NA3 8, 3NA6 8, 3NA7 8; Size: 000, 00; Operating class gG; Rated voltage: AC 500 V/DC 250 V

Short-circuit Selectivity PKP62 towards Neozed¹⁾ / Diazed²⁾ / NH00³⁾

Short-circuit currents in kA, rated currents of fuses in A

Short-circuit selectivity **PKP62** towards **Neozed¹⁾**

PKP62	Neozed ¹⁾										
	I _n [A]	16	20	25	32	35	40	50	63	80	100
B10	<0.5	0.5	0.9	2	2.3	3.7	6	6	6	6	6
B13	<0.5	0.5	0.8	1.7	1.9	3	6	6	6	6	6
B16		0.5	0.7	1.5	1.7	2.4	4.4	6	6	6	6
B20			0.7	1.4	1.5	2.2	4	6	6	6	6
B25				1.2	1.3	1.8	3.1	4.7	6	6	6
B32					1.2	1.7	2.7	3.8	5.5	6	6
B40						1.3	1.7	2.2	2.7	4.2	6
C10	<0.5	0.5	0.8	1.7	1.9	3	6	6	6	6	6
C13	<0.5	0.5	0.7	1.6	1.8	2.8	5.5	6	6	6	6
C16		<0.5	0.7	1.3	1.5	2.2	4	6	6	6	6
C20			0.6	1.3	1.4	2.1	3.7	5.6	6	6	6
C25				1.1	1.3	1.8	2.8	3.9	5.6	6	6
C32					1.2	1.7	2.6	3.6	5.1	6	6
C40						1.3	1.9	3.3	3.2	5.8	6

Short-circuit selectivity **PKP62** towards **Diazed¹⁾**

PKP62	Diazed ²⁾									
	I _n [A]	16	20	25	32	35	50	63	80	100
B10	<0.5	0.5	0.9	1.8	2.9	5.6	6	6	6	6
B13	<0.5	0.5	0.8	1.5	2.4	4.5	6	6	6	6
B16		0.5	0.8	1.3	2	3.4	6	6	6	6
B20			0.7	1.3	1.9	3.1	6	6	6	6
B25				1.1	1.5	2.4	5.5	6	6	6
B32					1.4	2.1	4.3	6	6	6
B40						1.4	2.4	2.9	5.1	6
C10	<0.5	0.5	0.8	1.5	2.4	4.4	6	6	6	6
C13	<0.5	0.5	0.8	1.4	2.3	4.2	6	6	6	6
C16		<0.5	0.7	1.2	1.9	3.2	6	6	6	6
C20			0.7	1.2	1.8	2.9	6	6	6	6
C25				1.1	1.5	2.3	4.4	6	6	6
C32					1.4	2.2	4.1	5.6	6	6
C40						1.6	2.8	3.6	6	6

Short-circuit selectivity **PKP62** towards **NH00³⁾**

PKP62	NH00 ³⁾												
	I _n [A]	16	20	25	32	35	40	50	63	80	100	125	160
B10	<0.5	<0.5	0.8	1.5	2.3	3.2	5.7	6	6	6	6	6	6
B13	<0.5	<0.5	0.8	1.3	1.9	2.7	4.4	6	6	6	6	6	6
B16		<0.5	0.7	1.1	1.6	2.2	3.4	4.8	6	6	6	6	6
B20			0.6	1	1.4	2	3.1	4.3	6	6	6	6	6
B25				0.9	1.2	1.6	2.4	3.4	5.5	6	6	6	6
B32					1.1	1.4	2.1	2.9	4.3	6	6	6	6
B40							1.4	1.9	2.8	4.1	6	6	6
C10	<0.5	<0.5	0.7	1.3	1.9	2.7	4.5	6	6	6	6	6	6
C13	<0.5	<0.5	0.7	1.2	1.8	2.5	4.1	6	6	6	6	6	6
C16		<0.5	0.6	1	1.5	2	3.1	4.4	6	6	6	6	6
C20			0.6	0.9	1.4	1.9	2.9	4.1	6	6	6	6	6
C25				0.9	1.2	1.6	2.3	3	4.6	6	6	6	6
C32					1.1	1.5	2.1	2.8	4.3	6	6	6	6
C40							1.5	2.1	3.1	5.4	6	6	6

Darker areas: no selectivity

¹⁾ SIEMENS Type 5SE2; Size: D01, D02, D03; Operating class gG; Rated voltage: AC 400 V/DC 250 V²⁾ SIEMENS Type 5SB2, 5SB4, 5SC2; Size: DII, DIII, DIV; Operating class gG; Rated voltage: AC 500 V/DC 500 V³⁾ SIEMENS Type 3NA3 8, 3NA6 8, 3NA7 8; Size: 000, 00; Operating class gG; Rated voltage: AC 500 V/DC 250 V

Short-circuit Selectivity PKP42 towards Neozed¹⁾ / Diazed²⁾ / NH00³⁾

Short-circuit currents in kA, rated currents of fuses in A

Short-circuit selectivity **PKP42** towards **Neozed** ¹⁾

PKP42	Neozed ¹⁾										
	I _n [A]	16	20	25	32	35	40	50	63	80	100
B10	<0.5	0.5	0.9	2	2.3	3.7	4.5	4.5	4.5	4.5	
B13	<0.5	0.5	0.8	1.7	1.9	3	4.5	4.5	4.5	4.5	
B16		0.5	0.7	1.5	1.7	2.4	4.4	4.5	4.5	4.5	
B20			0.7	1.4	1.5	2.2	4	4.5	4.5	4.5	
B25				1.2	1.3	1.8	3.1	4.7	4.5	4.5	
B32					1.2	1.7	2.7	3.8	4.5	4.5	
B40						1.3	1.7	2.2	2.7	4.2	
C10	<0.5	0.5	0.8	1.7	1.9	3	4.5	4.5	4.5	4.5	
C13	<0.5	0.5	0.7	1.6	1.8	2.8	4.5	4.5	4.5	4.5	
C16		<0.5	0.7	1.3	1.5	2.2	4	4.5	4.5	4.5	
C20			0.6	1.3	1.4	2.1	3.7	4.5	4.5	4.5	
C25				1.1	1.3	1.8	2.8	3.9	4.5	4.5	
C32					1.2	1.7	2.6	3.6	4.5	4.5	
C40						1.3	1.9	3.3	3.2	4.5	

Short-circuit selectivity **PKP42** towards **Diazed** ¹⁾

PKP42	Diazed ²⁾									
	I _n [A]	16	20	25	32	35	50	63	80	100
B10	<0.5	0.5	0.9	1.8	2.9	4.5	4.5	4.5	4.5	4.5
B13	<0.5	0.5	0.8	1.5	2.4	4.5	4.5	4.5	4.5	4.5
B16		0.5	0.8	1.3	2	3.4	4.5	4.5	4.5	4.5
B20			0.7	1.3	1.9	3.1	4.5	4.5	4.5	4.5
B25				1.1	1.5	2.4	4.5	4.5	4.5	4.5
B32					1.4	2.1	4.3	4.5	4.5	4.5
B40						1.4	2.4	2.9	4.5	4.5
C10	<0.5	0.5	0.8	1.5	2.4	4.4	4.5	4.5	4.5	4.5
C13	<0.5	0.5	0.8	1.4	2.3	4.2	4.5	4.5	4.5	4.5
C16		<0.5	0.7	1.2	1.9	3.2	4.5	4.5	4.5	4.5
C20			0.7	1.2	1.8	2.9	4.5	4.5	4.5	4.5
C25				1.1	1.5	2.3	4.4	4.5	4.5	4.5
C32					1.4	2.2	4.1	4.5	4.5	4.5
C40						1.6	2.8	3.6	4.5	4.5

Short-circuit selectivity **PKP42** towards **NH00** ³⁾

PKP42	NH00 ³⁾												
	I _n [A]	16	20	25	32	35	40	50	63	80	100	125	160
B10	<0.5	<0.5	0.8	1.5	2.3	3.2	4.5	4.5	4.5	4.5	4.5	4.5	4.5
B13	<0.5	<0.5	0.8	1.3	1.9	2.7	4.4	4.5	4.5	4.5	4.5	4.5	4.5
B16		<0.5	0.7	1.1	1.6	2.2	3.4	4.5	4.5	4.5	4.5	4.5	4.5
B20			0.6	1	1.4	2	3.1	4.3	4.5	4.5	4.5	4.5	4.5
B25				0.9	1.2	1.6	2.4	3.4	4.5	4.5	4.5	4.5	4.5
B32					1.1	1.4	2.1	2.9	4.3	4.5	4.5	4.5	4.5
B40						1.4	1.9	2.8	4.1	4.5	4.5	4.5	4.5
C10	<0.5	<0.5	0.7	1.3	1.9	2.7	4.5	4.5	4.5	4.5	4.5	4.5	4.5
C13	<0.5	<0.5	0.7	1.2	1.8	2.5	4.1	4.5	4.5	4.5	4.5	4.5	4.5
C16		<0.5	0.6	1	1.5	2	3.1	4.4	4.5	4.5	4.5	4.5	4.5
C20			0.6	0.9	1.4	1.9	2.9	4.1	4.5	4.5	4.5	4.5	4.5

Darker areas: no selectivity

¹⁾ SIEMENS Type 5SE2; Size: D01, D02, D03; Operating class gG; Rated voltage: AC 400 V/DC 250 V

²⁾ SIEMENS Type 5SB2, 5SB4, 5SC2; Size: DII, DIII, DIV; Operating class gG; Rated voltage: AC 500 V/DC 500 V

³⁾ SIEMENS Type 3NA3 8, 3NA6 8, 3NA7 8; Size: 000, 00; Operating class gG; Rated voltage: AC 500 V/DC 250 V

Let-through Energy PKP.2-../2/

Let-through Energy PKPM2, Characteristic B, 2-pole

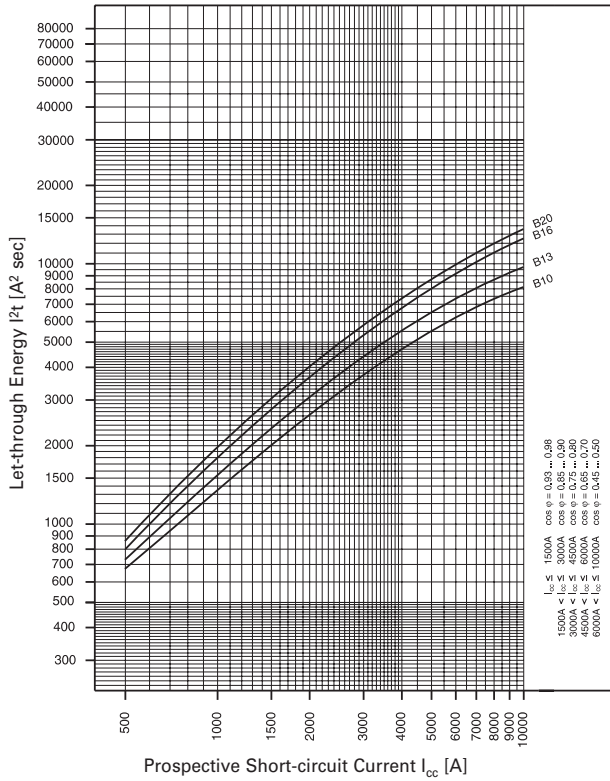

Let-through Energy PKPM2, Characteristic C, 2-pole

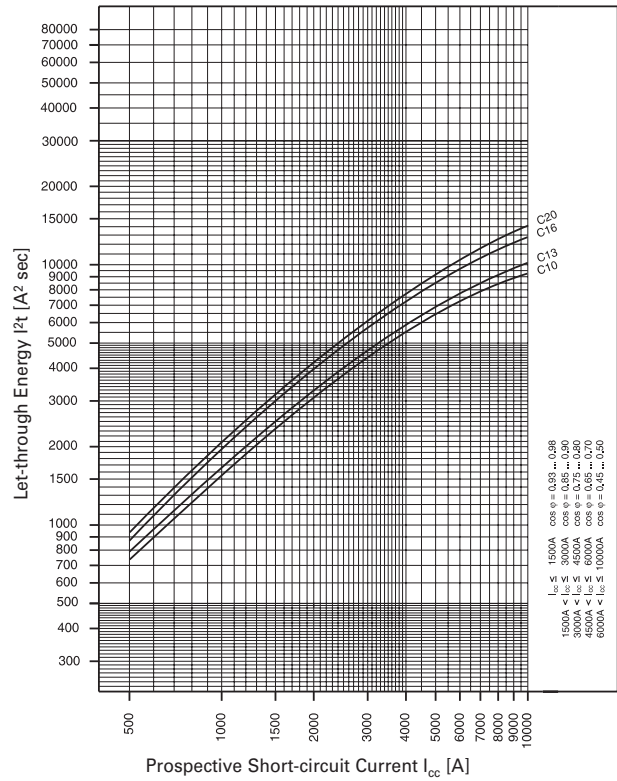

Let-through Energy PKP62, Characteristic B, 2-pole

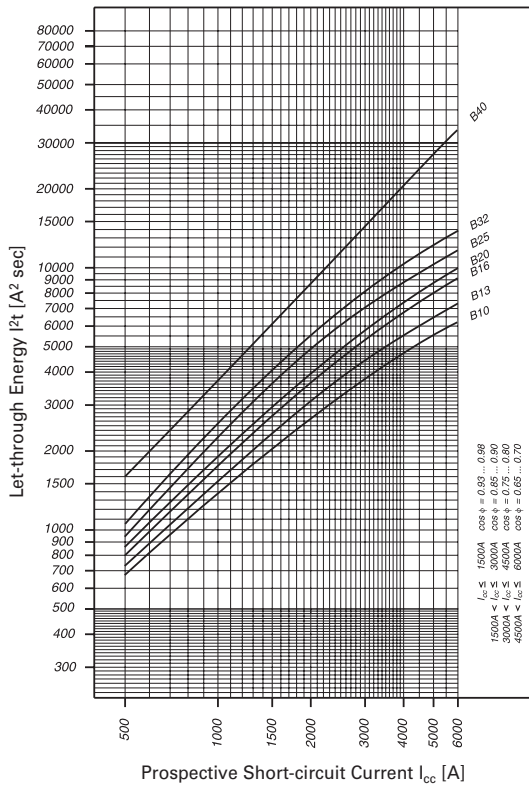

Let-through Energy PKP62, Characteristic C, 2-pole

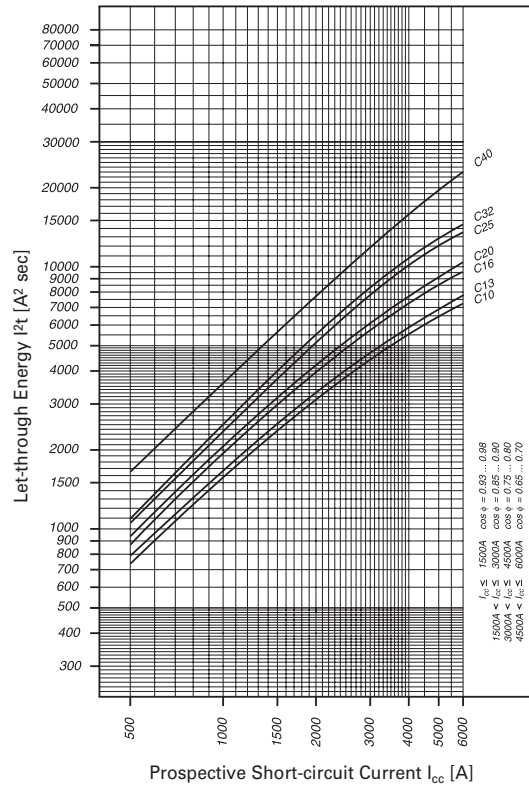

Let-through Energy PKP42, Characteristic B, 2-pole

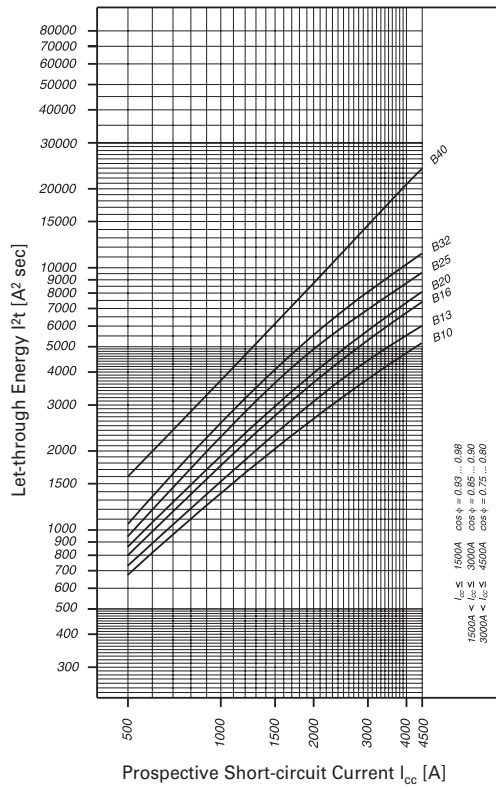

Let-through Energy PKP42, Characteristic C, 2-pole

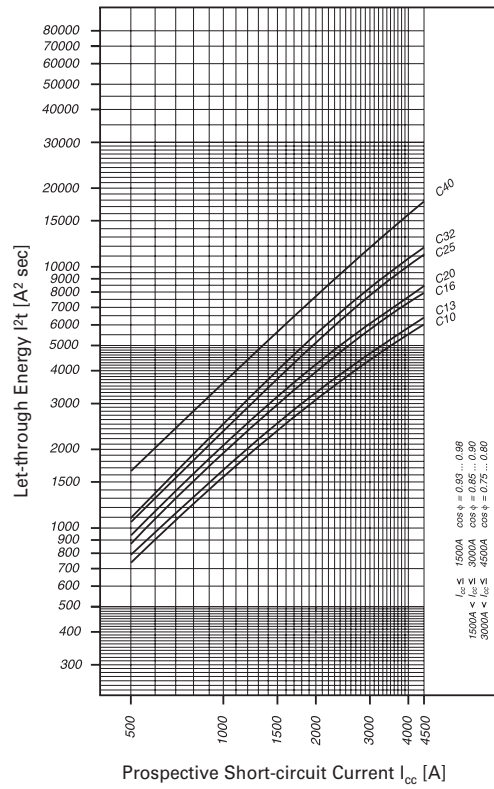

SG49512



Description

- High-quality residual current device / miniature circuit breaker combination, line voltage-independent
- Contact position indicator red - green
- Fault current tripping indicator white - blue
- Guide for secure terminal connection
- 3-position DIN rail clip, permits removal from existing busbar system
- Comprehensive range of accessories can be mounted subsequently
- Wide variety of rated tripping currents
- Rated currents up to towards 20 A
- Tripping characteristics B, C
- Rated breaking capacity 10 kA

$I_n/I_{\Delta n}$
(A)

Type
Designation

Article No.

Units per
package

Type Li/A

10 kA, 3-pole

increased surge current proofness, sensitive to residual pulsating DC

SG49512



Characteristic B

$I_n/I_{\Delta n}$	Type Designation	Article No.	Units per package
10/0.03	PKPM3-10/3/B/003-Li/A	196651	1/30
13/0.03	PKPM3-13/3/B/003-Li/A	196655	1/30
16/0.03	PKPM3-16/3/B/003-Li/A	196658	1/30
20/0.03	PKPM3-20/3/B/003-Li/A	196663	1/30
10/0.1	PKPM3-10/3/B/01-Li/A	196650	1/30
13/0.1	PKPM3-13/3/B/01-Li/A	196654	1/30
16/0.1	PKPM3-16/3/B/01-Li/A	196659	1/30
20/0.1	PKPM3-20/3/B/01-Li/A	196662	1/30

SG49512



Characteristic C

$I_n/I_{\Delta n}$	Type Designation	Article No.	Units per package
10/0.03	PKPM3-10/3/C/003-Li/A	196652	1/30
13/0.03	PKPM3-13/3/C/003-Li/A	196656	1/30
16/0.03	PKPM3-16/3/C/003-Li/A	196660	1/30
20/0.03	PKPM3-20/3/C/003-Li/A	196664	1/30
32/0.03	PKPM3-32/3/C/003-Li/A	196668	1/30
10/0.1	PKPM3-10/3/C/01-Li/A	196653	1/30
13/0.1	PKPM3-13/3/C/01-Li/A	196657	1/30
16/0.1	PKPM3-16/3/C/01-Li/A	196661	1/30
20/0.1	PKPM3-20/3/C/01-Li/A	196665	1/30
32/0.1	PKPM3-32/3/C/01-Li/A	196669	1/30

Type A

10 kA, 3-pole

Conditionally surge current-proof 250 A, sensitive to residual pulsating DC, type A

SG49512



Characteristic B

$I_n/I_{\Delta n}$	Type Designation	Article No.	Units per package
10/0.03	PKPM3-10/3/B/003-A	108322	1/30
13/0.03	PKPM3-13/3/B/003-A	108323	1/30
16/0.03	PKPM3-16/3/B/003-A	108324	1/30
20/0.03	PKPM3-20/3/B/003-A	108325	1/30
10/0.1	PKPM3-10/3/B/01-A	108129	1/30
13/0.1	PKPM3-13/3/B/01-A	108130	1/30
16/0.1	PKPM3-16/3/B/01-A	108131	1/30
20/0.1	PKPM3-20/3/B/01-A	108132	1/30

SG49512



Characteristic C

$I_n/I_{\Delta n}$	Type Designation	Article No.	Units per package
10/0.03	PKPM3-10/3/C/003-A	108326	1/30
13/0.03	PKPM3-13/3/C/003-A	108327	1/30
16/0.03	PKPM3-16/3/C/003-A	108328	1/30
20/0.03	PKPM3-20/3/C/003-A	108329	1/30
32/0.03	PKPM3-32/3/C/003-A	136564	1/30
10/0.1	PKPM3-10/3/C/01-A	108133	1/30
13/0.1	PKPM3-13/3/C/01-A	108134	1/30
16/0.1	PKPM3-16/3/C/01-A	108135	1/30
20/0.1	PKPM3-20/3/C/01-A	108136	1/30
32/0.1	PKPM3-32/3/C/01-A	136567	1/30

Specifications | Combined RCD/MCB Devices PKPM3, 3-pole

Description

- Combined RCD/MCB Devices
- Line voltage-independent tripping
- Compatible with standard busbar
- Twin-purpose terminal (lift/open-mouthed) above and below
- Busbar positioning optionally above or below
- Free terminal space despite installed busbar
- Guide for secure terminal connection
- Switching toggle (MCB component) in colour designating the rated current
- Contact position indicator red - green
- Fault current tripping indicator white - blue
- Comprehensive range of accessories can be mounted subsequently
- The test key "T" must be pressed every 6 month. The system operator must be informed of this obligation and his responsibility in a way that can be proven (self-adhesive RCD-label enclosed). The test interval of 6 month is valid for residential and similar applications. Under all other conditions (e.g. damply or dusty environments), it's recommended to test in shorter intervals (e.g. monthly).
- Pressing the test key "T" serves the only purpose of function testing the residual current device (RCD). This test does not make earthing resistance measurement (R_E), or proper checking of the earth conductor condition redundant, which must be performed separately.
- **Type -A:** Protects against special forms of residual pulsating DC which have not been smoothed
- **Type -Li/A:** Protects against special forms of residual pulsating DC which have not been smoothed.
10 ms time delay in order to avoid unwanted tripping (e.g. during thunderstorms).

Accessories:

Tripping signal switch for subsequent installation	ZP-IHK	286052
	ZP-NHK	248437
	ZP-WHK	286053
Shunt trip release	ZP-ASA/..	248438, 248439

Technical Data

		PKPM3, 3-pole
Electrical		
Design according to		IEC/EN 61009
Current test marks as printed onto the device		
Line voltage-independent tripping		instantaneous 250 A (8/20 μ s), surge current proof
Rated voltage	U_e	30 mA types: 230 V AC; 50 Hz 100 mA types: 230/400 V AC; 50 Hz
Rated tripping current	$I_{\Delta n}$	30, 100 mA
Rated non-tripping current	$I_{\Delta no}$	0.5 $I_{\Delta n}$
Sensitivity		AC and pulsating DC
Selectivity class		3
Rated breaking capacity	I_{cn}	10 kA
Rated current		10 - 20 A
Rated impulse withstand voltage	U_{imp}	4 kV (1.2/50 μ s)
Characteristic		B, C
Maximum back-up fuse (short-circuit)		100 A gL (>10 kA)
Endurance		
electrical components		$\geq 2,000$ switching operations
mechanical components		$\geq 10,000$ switching operations
Mechanical		
Frame size		45 mm
Device height		80 mm
Device width		70 mm (4 MU)
Mounting		3-position DIN rail clip, permits removal from existing busbar system
Degree of protection, switch		IP20
Degree of protection, built-in		IP40
Upper and lower terminals		open-mouthed/lift terminals
Terminal protection		finger and hand touch safe, DGVV VS3, EN 50274
Terminal capacity		1 - 25 mm ²
Terminal torque		2 - 2.4 Nm
Busbar thickness		0.8 - 2 mm
Operating temperature		-25°C to +40°C
Storage- and transport temperature		-35°C to +60°C
Resistance to climatic conditions		according to IEC/EN 61009

Connection diagram

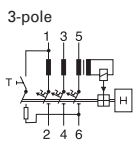

Dimensions (mm)

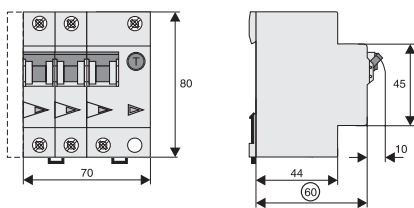

Tripping Characteristic PKPM3, Characteristics B and C

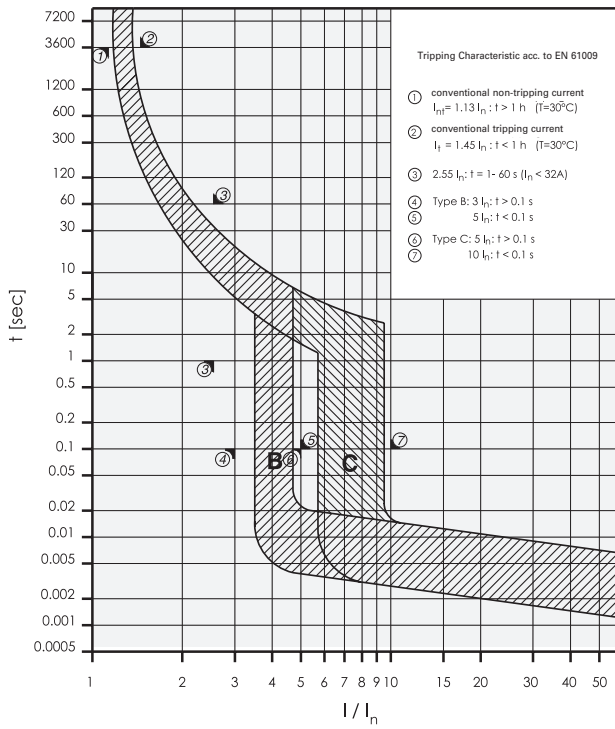

SG14211



Description

- High-quality residual current device / miniature circuit breaker combination, line voltage-independent
- Contact position indicator red - green
- Fault current tripping indicator white - blue
- Guide for secure terminal connection
- 3-position DIN rail clip, permits removal from existing busbar system
- Comprehensive range of accessories can be mounted subsequently
- Wide variety of rated tripping currents
- Rated currents up to 25 A
- Tripping characteristics B, C, D
- Rated breaking capacity 6 kA or 4.5 kA

1.4

Combined RCD/MCB Devices

xPole

Combined RCD/MCB Devices mRB6, 3+N-pole

$I_n/I_{\Delta n}$
(A)

Type
Designation

Article No.

Units per
package

Type A

6 kA, 3+N-pole

Conditionally surge current-proof 250 A, sensitive to residual pulsating DC, type A

SG14211



Characteristic B

13/0.03	mRB6-13/3N/B/003-A	120651	1/30
16/0.03	mRB6-16/3N/B/003-A	120652	1/30
13/0.1	mRB6-13/3N/B/01-A	120653	1/30
16/0.1	mRB6-16/3N/B/01-A	120654	1/30
13/0.3	mRB6-13/3N/B/03-A	120655	1/30
16/0.3	mRB6-16/3N/B/03-A	120656	1/30

SG14211



Characteristic C

6/0.03	mRB6-6/3N/C/003-A	120657	1/30
10/0.03	mRB6-10/3N/C/003-A	120658	1/30
13/0.03	mRB6-13/3N/C/003-A	120659	1/30
16/0.03	mRB6-16/3N/C/003-A	120660	1/30
6/0.1	mRB6-6/3N/C/01-A	120661	1/30
10/0.1	mRB6-10/3N/C/01-A	120662	1/30
13/0.1	mRB6-13/3N/C/01-A	120663	1/30
16/0.1	mRB6-16/3N/C/01-A	120664	1/30
6/0.3	mRB6-6/3N/C/03-A	120665	1/30
10/0.3	mRB6-10/3N/C/03-A	120666	1/30
13/0.3	mRB6-13/3N/C/03-A	120667	1/30
16/0.3	mRB6-16/3N/C/03-A	120668	1/30

SG14211



Characteristic D

6/0.03	mRB6-6/3N/D/003-A	120669	1/30
10/0.03	mRB6-10/3N/D/003-A	120670	1/30
13/0.03	mRB6-13/3N/D/003-A	120671	1/30
16/0.03	mRB6-16/3N/D/003-A	120672	1/30
6/0.1	mRB6-6/3N/D/01-A	120673	1/30
10/0.1	mRB6-10/3N/D/01-A	120674	1/30
13/0.1	mRB6-13/3N/D/01-A	120675	1/30
16/0.1	mRB6-16/3N/D/01-A	120676	1/30

$I_n/I_{\Delta n}$
(A)

Type
Designation

Article No. Units per
package

Type A

4.5 kA, 3+N-pole

Conditionally surge current-proof 250 A, sensitive to residual pulsating DC, type A

Characteristic C

20/0.03	mRB4-20/3N/C/003-A	120677	1/30
25/0.03	mRB4-25/3N/C/003-A	120678	1/30
32/0.03	mRB4-32/3N/C/003-A	167508	1/30
20/0.1	mRB4-20/3N/C/01-A	120679	1/30
25/0.1	mRB4-25/3N/C/01-A	120680	1/30
32/0.1	mRB4-32/3N/C/01-A	167509	1/30
20/0.3	mRB4-20/3N/C/03-A	120681	1/30
25/0.3	mRB4-25/3N/C/03-A	120682	1/30
32/0.3	mRB4-32/3N/C/03-A	167510	1/30

Characteristic D

20/0.03	mRB4-20/3N/D/003-A	120683	1/30
20/0.1	mRB4-20/3N/D/01-A	120684	1/30

wa_sg00213

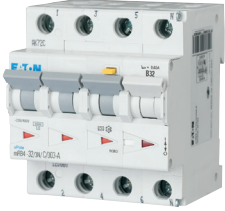

wa_sg00213



Specifications | Combined RCD/MCB Devices mRB., 3+N-pole

Description

- Combined RCD/MCB Devices
- Line voltage-independent tripping
- Compatible with standard busbar
- Twin-purpose terminal (lift/open-mouthed) above and below
- Busbar positioning optionally above or below
- Free terminal space despite installed busbar
- Guide for secure terminal connection
- Switching toggle (MCB component) in colour designating the rated current
- Contact position indicator red - green
- Fault current tripping indicator white - blue
- Comprehensive range of accessories can be mounted subsequently
- The test key "T" must be pressed every 6 month. The system operator must be informed of this obligation and his responsibility in a way that can be proven (self-adhesive RCD-label enclosed). The test interval of 6 month is valid for residential and similar applications. Under all other conditions (e.g. damply or dusty environments), it's recommended to test in shorter intervals (e.g. monthly).
- Pressing the test key "T" serves the only purpose of function testing the residual current device (RCD). This test does not make earthing resistance measurement (R_E), or proper checking of the earth conductor condition redundant, which must be performed separately.
- **Type -A:** Protects against special forms of residual pulsating DC which have not been smoothed

Accessories:

Tripping signal switch for subsequent installation	ZP-IHK	286052
	ZP-NHK	248437
	ZP-WHK	286053
Shunt trip release	ZP-ASA/..	248438, 248439

Technical Data

		mRB., 3+N-pole
Electrical		
Design according to		IEC/EN 61009
Current test marks as printed onto the device		
Line voltage-independent tripping		instantaneous 250 A (8/20 μ s), surge current proof
Rated voltage	U_e	230/400 V; 50 Hz
Rated tripping current	$I_{\Delta n}$	30, 100, 300 mA
Rated non-tripping current	$I_{\Delta no}$	0.5 $I_{\Delta n}$
Sensitivity		AC and pulsating DC
Selectivity class		3
Rated breaking capacity	I_{cn}	
mRB6		6 kA
mRB4		4.5 kA
Rated current		6 - 32 A
Rated impulse withstand voltage	U_{imp}	4 kV (1.2/50 μ s)
Characteristic		B, C, D
Maximum back-up fuse (short-circuit)		100 A gL/gG
Endurance		
electrical components		$\geq 4,000$ switching operations
mechanical components		$\geq 20,000$ switching operations
Mechanical		
Frame size		45 mm
Device height		80 mm
Device width		70 mm (4 MU)
Mounting		3-position DIN rail clip, permits removal from existing busbar system
Degree of protection, switch		IP20
Degree of protection, built-in		IP40
Upper and lower terminals		open-mouthed/lift terminals
Terminal protection		finger and hand touch safe, DGUV VS3, EN 50274
Terminal capacity		1 - 25 mm ²
Terminal torque		2 - 2.4 Nm
Busbar thickness		0.8 - 2 mm
Operating temperature		-25°C to +40°C
Storage- and transport temperature		-35°C to +60°C
Resistance to climatic conditions		according to IEC/EN 61009

Connection diagram

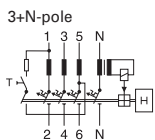

Dimensions (mm)

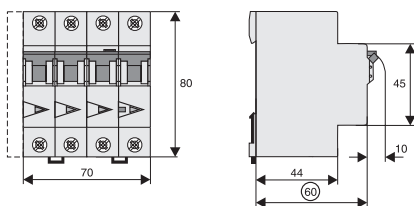

Tripping Characteristic mRB., Characteristics B, C and D

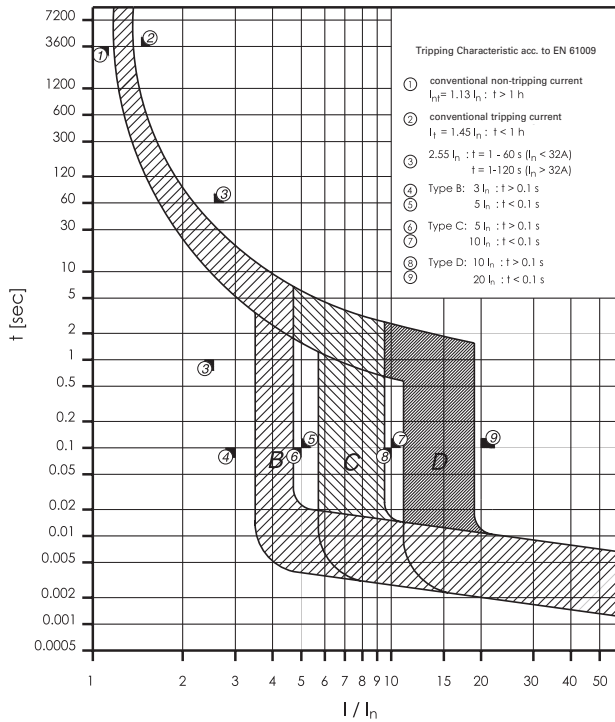

Power Loss at I_n mRB. 3+N-poles

	Typ B	Typ C	Typ D
(entire unit)			
I_n [A]	P* [W]	P* [W]	P* [W]
6	-	4.8	4.8
10	-	8.2	7.8
13	10.2	9.4	7.7
16	11.6	10.9	11.2
20	-	11.8	12.0
25	-	11.6	-
32	-	15.6	-

* 50Hz and ambient temperature

Back-up Protection between mRB. and NZM1

Short-circuit currents in kA.

mRB4/mRB6	NZMB1(C1)(N1)(H1)-A...		
	$U_e = 415$ V		
	B	C	D
6	-	20	20
10	-	20	20
13	20	20	20
16	20	20	20
20	-	20	20
25	-	20	-

$U_e = 415$ V: I_{cn} (mRB4) = 4.5 kA (acc. to IEC/EN 61009)
 $U_e = 415$ V: I_{cn} (mRB6) = 6 kA (acc. to IEC/EN 61009)
 $U_e = 400/415$ V: I_{cu} (NZMB1) = 25 kA (acc. to IEC/EN 60947-2)
 $U_e = 400/415$ V: I_{cu} (NZMC1) = 36 kA (acc. to IEC/EN 60947-2)
 $U_e = 400/415$ V: I_{cu} (NZMN1) = 50 kA (acc. to IEC/EN 60947-2)
 $U_e = 400/415$ V: I_{cu} (NZMH1) = 100 kA (acc. to IEC/EN 60947-2)

Back-up Protection between mRB. and NZM2

Short-circuit currents in kA.

mRB4/mRB6	NZMB2(C2)(N2)(H2)-A...		
	$U_e = 415$ V		
	B	C	D
6	-	20	20
10	-	20	20
13	20	20	20
16	20	20	20
20	-	20	20
25	-	20	-

$U_e = 415$ V: I_{cn} (mRB4) = 4.5 kA (acc. to IEC/EN 61009)
 $U_e = 415$ V: I_{cn} (mRB6) = 6 kA (acc. to IEC/EN 61009)
 $U_e = 400/415$ V: I_{cu} (NZMB2) = 25 kA (acc. to IEC/EN 60947-2)
 $U_e = 400/415$ V: I_{cu} (NZMC2) = 36 kA (acc. to IEC/EN 60947-2)
 $U_e = 400/415$ V: I_{cu} (NZMN2) = 50 kA (acc. to IEC/EN 60947-2)
 $U_e = 400/415$ V: I_{cu} (NZMH2) = 150 kA (acc. to IEC/EN 60947-2)

Back-up Protection between mRB. and PLSM-OV63

Short-circuit currents in kA.

mRB4/mRB6	PLSM-OV63		
	$U_e = 400$ V		
	B	C	D
6	-	10	10
10	-	10	10
13	10	10	10
16	10	10	10
20	-	10	10
25	-	10	-

$U_e = 415$ V: I_{cn} (mRB4) = 4.5 kA (acc. to IEC/EN 61009)
 $U_e = 415$ V: I_{cn} (mRB6) = 6 kA (acc. to IEC/EN 61009)
 $U_e = 400$ V: I_{cu} (PLSM-OV) = 10 kA (acc. to IEC/EN 60947-2)

Back-up Protection between mRB. and PLHT-OV80

Short-circuit currents in kA.

mRB4/mRB6	PLHT-OV80		
	$U_e = 400$ V		
	B	C	D
6	-	20	20
10	-	20	20
13	20	20	20
16	20	20	20
20	-	20	20
25	-	20	-

$U_e = 415$ V: I_{cn} (mRB4) = 4.5 kA (acc. to IEC/EN 61009)
 $U_e = 415$ V: I_{cn} (mRB6) = 6 kA (acc. to IEC/EN 61009)
 $U_e = 400$ V: I_{cu} (PLHT-80) = 20 kA (acc. to IEC/EN 60947-2)

SG08210



Description

- High-quality residual current device / miniature circuit breaker combination, line voltage-independent
- Version -PT specific for applications in the BS-distribution systems, permanently connected neutral conductors
- Contact position indicator red - green
- Fault current tripping indicator white - blue
- Guide for secure terminal connection
- 3-position DIN rail clip, permits removal from existing busbar system
- Comprehensive range of accessories can be mounted subsequently
- Wide variety of rated tripping currents
- Rated currents up to 32 A
- Tripping characteristics B, C, D
- Rated breaking capacity 10 kA

1.4

Combined RCD/MCB Devices

xPole

Combined RCD/MCB Devices mRBM4-PT, 3+N-pole

$I_n/I_{\Delta n}$
(A)

Type
Designation

Article No.

Units per
package

Type A

10 kA, 3+N-pole

Conditionally surge current-proof 250 A, sensitive to residual pulsating DC, type A

SG08210



Characteristic B

10/0.03	mRBM4-10/3/B/003-A-PT	149465	1/20
13/0.03	mRBM4-13/3/B/003-A-PT	149466	1/20
16/0.03	mRBM4-16/3/B/003-A-PT	149467	1/20
20/0.03	mRBM4-20/3/B/003-A-PT	149468	1/20
10/0.1	mRBM4-10/3/B/01-A-PT	149499	1/20
13/0.1	mRBM4-13/3/B/01-A-PT	149500	1/20
16/0.1	mRBM4-16/3/B/01-A-PT	149501	1/20
20/0.1	mRBM4-20/3/B/01-A-PT	149502	1/20
10/0.3	mRBM4-10/3/B/03-A-PT	149533	1/20
13/0.3	mRBM4-13/3/B/03-A-PT	149534	1/20
16/0.3	mRBM4-16/3/B/03-A-PT	149535	1/20
20/0.3	mRBM4-20/3/B/03-A-PT	149536	1/20

SG08210



Characteristic C

6/0.03	mRBM4-6/3/C/003-A-PT	149469	1/20
10/0.03	mRBM4-10/3/C/003-A-PT	149470	1/20
13/0.03	mRBM4-13/3/C/003-A-PT	149471	1/20
16/0.03	mRBM4-16/3/C/003-A-PT	149472	1/20
20/0.03	mRBM4-20/3/C/003-A-PT	149473	1/20
25/0.03	mRBM4-25/3/C/003-A-PT	149474	1/20
32/0.03	mRBM4-32/3/C/003-A-PT	149475	1/20
6/0.1	mRBM4-6/3/C/01-A-PT	149503	1/20
10/0.1	mRBM4-10/3/C/01-A-PT	149504	1/20
13/0.1	mRBM4-13/3/C/01-A-PT	149505	1/20
16/0.1	mRBM4-16/3/C/01-A-PT	149506	1/20
20/0.1	mRBM4-20/3/C/01-A-PT	149507	1/20
25/0.1	mRBM4-25/3/C/01-A-PT	149508	1/20
32/0.1	mRBM4-32/3/C/01-A-PT	149509	1/20
6/0.3	mRBM4-6/3/C/03-A-PT	149537	1/20
10/0.3	mRBM4-10/3/C/03-A-PT	149538	1/20
13/0.3	mRBM4-13/3/C/03-A-PT	149539	1/20
16/0.3	mRBM4-16/3/C/03-A-PT	149540	1/20
20/0.3	mRBM4-20/3/C/03-A-PT	149541	1/20
25/0.3	mRBM4-25/3/C/03-A-PT	149542	1/20
32/0.3	mRBM4-32/3/C/03-A-PT	149543	1/20

SG08210



Characteristic D

6/0.03	mRBM4-6/3/D/003-A-PT	149476	1/20
10/0.03	mRBM4-10/3/D/003-A-PT	149477	1/20
13/0.03	mRBM4-13/3/D/003-A-PT	149478	1/20
16/0.03	mRBM4-16/3/D/003-A-PT	149479	1/20
20/0.03	mRBM4-20/3/D/003-A-PT	149480	1/20
25/0.03	mRBM4-25/3/D/003-A-PT	149481	1/20
6/0.1	mRBM4-6/3/D/01-A-PT	149510	1/20
10/0.1	mRBM4-10/3/D/01-A-PT	149511	1/20
13/0.1	mRBM4-13/3/D/01-A-PT	149512	1/20
16/0.1	mRBM4-16/3/D/01-A-PT	149513	1/20
20/0.1	mRBM4-20/3/D/01-A-PT	149514	1/20
25/0.1	mRBM4-25/3/D/01-A-PT	149515	1/20
6/0.3	mRBM4-6/3/D/03-A-PT	149544	1/20
10/0.3	mRBM4-10/3/D/03-A-PT	149545	1/20
13/0.3	mRBM4-13/3/D/03-A-PT	149546	1/20
16/0.3	mRBM4-16/3/D/03-A-PT	149547	1/20
20/0.3	mRBM4-20/3/D/03-A-PT	149548	1/20
25/0.3	mRBM4-25/3/D/03-A-PT	149549	1/20

$I_n/I_{\Delta n}$ (A)	Type Designation	Article No.	Units per package
---------------------------	---------------------	-------------	----------------------

Type AC

10 kA, 3+N-pole
Conditionally surge current-proof 250 A, type AC

SG08210



Characteristic B

10/0.03	mRBM4-10/3/B/003-PT	149482	1/20
13/0.03	mRBM4-13/3/B/003-PT	149483	1/20
16/0.03	mRBM4-16/3/B/003-PT	149484	1/20
20/0.03	mRBM4-20/3/B/003-PT	149485	1/20
10/0.1	mRBM4-10/3/B/01-PT	149516	1/20
13/0.1	mRBM4-13/3/B/01-PT	149517	1/20
16/0.1	mRBM4-16/3/B/01-PT	149518	1/20
20/0.1	mRBM4-20/3/B/01-PT	149519	1/20
10/0.3	mRBM4-10/3/B/03-PT	149550	1/20
13/0.3	mRBM4-13/3/B/03-PT	149551	1/20
16/0.3	mRBM4-16/3/B/03-PT	149552	1/20
20/0.3	mRBM4-20/3/B/03-PT	149553	1/20

SG08210



Characteristic C

6/0.03	mRBM4-6/3/C/003-PT	149486	1/20
10/0.03	mRBM4-10/3/C/003-PT	149487	1/20
13/0.03	mRBM4-13/3/C/003-PT	149488	1/20
16/0.03	mRBM4-16/3/C/003-PT	149489	1/20
20/0.03	mRBM4-20/3/C/003-PT	149490	1/20
25/0.03	mRBM4-25/3/C/003-PT	149491	1/20
32/0.03	mRBM4-32/3/C/003-PT	149492	1/20
6/0.1	mRBM4-6/3/C/01-PT	149520	1/20
10/0.1	mRBM4-10/3/C/01-PT	149521	1/20
13/0.1	mRBM4-13/3/C/01-PT	149522	1/20
16/0.1	mRBM4-16/3/C/01-PT	149523	1/20
20/0.1	mRBM4-20/3/C/01-PT	149524	1/20
25/0.1	mRBM4-25/3/C/01-PT	149525	1/20
32/0.1	mRBM4-32/3/C/01-PT	149526	1/20
6/0.3	mRBM4-6/3/C/03-PT	149554	1/20
10/0.3	mRBM4-10/3/C/03-PT	149555	1/20
13/0.3	mRBM4-13/3/C/03-PT	149556	1/20
16/0.3	mRBM4-16/3/C/03-PT	149557	1/20
20/0.3	mRBM4-20/3/C/03-PT	149558	1/20
25/0.3	mRBM4-25/3/C/03-PT	149559	1/20
32/0.3	mRBM4-32/3/C/03-PT	149560	1/20

SG08210



Characteristic D

6/0.03	mRBM4-6/3/D/003-PT	149493	1/20
10/0.03	mRBM4-10/3/D/003-PT	149494	1/20
13/0.03	mRBM4-13/3/D/003-PT	149495	1/20
16/0.03	mRBM4-16/3/D/003-PT	149496	1/20
20/0.03	mRBM4-20/3/D/003-PT	149497	1/20
25/0.03	mRBM4-25/3/D/003-PT	149498	1/20
6/0.1	mRBM4-6/3/D/01-PT	149527	1/20
10/0.1	mRBM4-10/3/D/01-PT	149528	1/20
13/0.1	mRBM4-13/3/D/01-PT	149529	1/20
16/0.1	mRBM4-16/3/D/01-PT	149530	1/20
20/0.1	mRBM4-20/3/D/01-PT	149531	1/20
25/0.1	mRBM4-25/3/D/01-PT	149532	1/20
6/0.3	mRBM4-6/3/D/03-PT	149561	1/20
10/0.3	mRBM4-10/3/D/03-PT	149562	1/20
13/0.3	mRBM4-13/3/D/03-PT	149563	1/20
16/0.3	mRBM4-16/3/D/03-PT	149564	1/20
20/0.3	mRBM4-20/3/D/03-PT	149565	1/20
25/0.3	mRBM4-25/3/D/03-PT	149566	1/20

SG08210



Description

- High-quality residual current device / miniature circuit breaker combination, line voltage-independent
- Version -PT specific for applications in the BS-distribution systems, permanently connected neutral conductors
- Contact position indicator red - green
- Fault current tripping indicator white - blue
- Guide for secure terminal connection
- 3-position DIN rail clip, permits removal from existing busbar system
- Comprehensive range of accessories can be mounted subsequently
- Wide variety of rated tripping currents
- Rated currents up to 32 A
- Tripping characteristics B, C, D
- Rated breaking capacity 10 kA

$I_n/I_{\Delta n}$
(A)

Type
Designation

Article No.

Units per
package

Type A

10 kA, 3+N-pole

Conditionally surge current-proof 250 A, sensitive to residual pulsating DC, type A

SG08210



Characteristic B

10/0.03	mRBM4-10/3/B/003-A-UK-PT	169636	1/24
13/0.03	mRBM4-13/3/B/003-A-UK-PT	169637	1/24
16/0.03	mRBM4-16/3/B/003-A-UK-PT	169638	1/24
20/0.03	mRBM4-20/3/B/003-A-UK-PT	169639	1/24
10/0.1	mRBM4-10/3/B/01-A-UK-PT	169670	1/24
13/0.1	mRBM4-13/3/B/01-A-UK-PT	169671	1/24
16/0.1	mRBM4-16/3/B/01-A-UK-PT	169584	1/24
20/0.1	mRBM4-20/3/B/01-A-UK-PT	169585	1/24
10/0.3	mRBM4-10/3/B/03-A-UK-PT	169598	1/24
13/0.3	mRBM4-13/3/B/03-A-UK-PT	169599	1/24
16/0.3	mRBM4-16/3/B/03-A-UK-PT	169600	1/24
20/0.3	mRBM4-20/3/B/03-A-UK-PT	169601	1/24

SG08210



Characteristic C

6/0.03	mRBM4-6/3/C/003-A-UK-PT	169640	1/24
10/0.03	mRBM4-10/3/C/003-A-UK-PT	169641	1/24
13/0.03	mRBM4-13/3/C/003-A-UK-PT	169642	1/24
16/0.03	mRBM4-16/3/C/003-A-UK-PT	169643	1/24
20/0.03	mRBM4-20/3/C/003-A-UK-PT	169644	1/24
25/0.03	mRBM4-25/3/C/003-A-UK-PT	169645	1/24
32/0.03	mRBM4-32/3/C/003-A-UK-PT	169646	1/24
6/0.1	mRBM4-6/3/C/01-A-UK-PT	169586	1/24
10/0.1	mRBM4-10/3/C/01-A-UK-PT	169587	1/24
13/0.1	mRBM4-13/3/C/01-A-UK-PT	169588	1/24
16/0.1	mRBM4-16/3/C/01-A-UK-PT	169589	1/24
20/0.1	mRBM4-20/3/C/01-A-UK-PT	169590	1/24
25/0.1	mRBM4-25/3/C/01-A-UK-PT	169591	1/24
32/0.1	mRBM4-32/3/C/01-A-UK-PT	169592	1/24
6/0.3	mRBM4-6/3/C/03-A-UK-PT	169602	1/24
10/0.3	mRBM4-10/3/C/03-A-UK-PT	169603	1/24
13/0.3	mRBM4-13/3/C/03-A-UK-PT	169604	1/24
16/0.3	mRBM4-16/3/C/03-A-UK-PT	169605	1/24
20/0.3	mRBM4-20/3/C/03-A-UK-PT	169606	1/24
25/0.3	mRBM4-25/3/C/03-A-UK-PT	169607	1/24
32/0.3	mRBM4-32/3/C/03-A-UK-PT	169608	1/24

SG08210



Characteristic D

6/0.03	mRBM4-6/3/D/003-A-UK-PT	169647	1/24
10/0.03	mRBM4-10/3/D/003-A-UK-PT	169648	1/24
13/0.03	mRBM4-13/3/D/003-A-UK-PT	169649	1/24
16/0.03	mRBM4-16/3/D/003-A-UK-PT	169650	1/24
20/0.03	mRBM4-20/3/D/003-A-UK-PT	169651	1/24
25/0.03	mRBM4-25/3/D/003-A-UK-PT	169652	1/24
6/0.1	mRBM4-6/3/D/01-A-UK-PT	169593	1/24
10/0.1	mRBM4-10/3/D/01-A-UK-PT	169594	1/24
13/0.1	mRBM4-13/3/D/01-A-UK-PT	169618	1/24
16/0.1	mRBM4-16/3/D/01-A-UK-PT	169619	1/24
20/0.1	mRBM4-20/3/D/01-A-UK-PT	169620	1/24
25/0.1	mRBM4-25/3/D/01-A-UK-PT	169621	1/24
6/0.3	mRBM4-6/3/D/03-A-UK-PT	169609	1/24
10/0.3	mRBM4-10/3/D/03-A-UK-PT	169610	1/24
13/0.3	mRBM4-13/3/D/03-A-UK-PT	169611	1/24
16/0.3	mRBM4-16/3/D/03-A-UK-PT	169612	1/24
20/0.3	mRBM4-20/3/D/03-A-UK-PT	169613	1/24
25/0.3	mRBM4-25/3/D/03-A-UK-PT	169614	1/24

1.4

Combined RCD/MCB Devices

xPole

Combined RCD/MCB Devices mRBM4-UK-PT, 3+N-pole

$I_n/I_{\Delta n}$
(A)

Type
Designation

Article No.

Units per
package

Type AC

10 kA, 3+N-pole

Conditionally surge current-proof 250 A, type AC

SG08210



Characteristic B

10/0.03	mRBM4-10/3/B/003-UK-PT	169653	1/24
13/0.03	mRBM4-13/3/B/003-UK-PT	169654	1/24
16/0.03	mRBM4-16/3/B/003-UK-PT	169655	1/24
20/0.03	mRBM4-20/3/B/003-UK-PT	169656	1/24
10/0.1	mRBM4-10/3/B/01-UK-PT	169622	1/24
13/0.1	mRBM4-13/3/B/01-UK-PT	169623	1/24
16/0.1	mRBM4-16/3/B/01-UK-PT	169624	1/24
20/0.1	mRBM4-20/3/B/01-UK-PT	169625	1/24
10/0.3	mRBM4-10/3/B/03-UK-PT	169615	1/24
13/0.3	mRBM4-13/3/B/03-UK-PT	169616	1/24
16/0.3	mRBM4-16/3/B/03-UK-PT	169617	1/24
20/0.3	mRBM4-20/3/B/03-UK-PT	169672	1/24

SG08210



Characteristic C

6/0.03	mRBM4-6/3/C/003-UK-PT	169657	1/24
10/0.03	mRBM4-10/3/C/003-UK-PT	169658	1/24
13/0.03	mRBM4-13/3/C/003-UK-PT	169659	1/24
16/0.03	mRBM4-16/3/C/003-UK-PT	169660	1/24
20/0.03	mRBM4-20/3/C/003-UK-PT	169661	1/24
25/0.03	mRBM4-25/3/C/003-UK-PT	169662	1/24
32/0.03	mRBM4-32/3/C/003-UK-PT	169663	1/24
6/0.1	mRBM4-6/3/C/01-UK-PT	169626	1/24
10/0.1	mRBM4-10/3/C/01-UK-PT	169627	1/24
13/0.1	mRBM4-13/3/C/01-UK-PT	169628	1/24
16/0.1	mRBM4-16/3/C/01-UK-PT	169629	1/24
20/0.1	mRBM4-20/3/C/01-UK-PT	169630	1/24
25/0.1	mRBM4-25/3/C/01-UK-PT	169631	1/24
32/0.1	mRBM4-32/3/C/01-UK-PT	169632	1/24
6/0.3	mRBM4-6/3/C/03-UK-PT	169673	1/24
10/0.3	mRBM4-10/3/C/03-UK-PT	169674	1/24
13/0.3	mRBM4-13/3/C/03-UK-PT	169675	1/24
16/0.3	mRBM4-16/3/C/03-UK-PT	169676	1/24
20/0.3	mRBM4-20/3/C/03-UK-PT	169677	1/24
25/0.3	mRBM4-25/3/C/03-UK-PT	169678	1/24
32/0.3	mRBM4-32/3/C/03-UK-PT	169679	1/24

SG08210



Characteristic D

6/0.03	mRBM4-6/3/D/003-UK-PT	169664	1/24
10/0.03	mRBM4-10/3/D/003-UK-PT	169665	1/24
13/0.03	mRBM4-13/3/D/003-UK-PT	169666	1/24
16/0.03	mRBM4-16/3/D/003-UK-PT	169667	1/24
20/0.03	mRBM4-20/3/D/003-UK-PT	169668	1/24
25/0.03	mRBM4-25/3/D/003-UK-PT	169669	1/24
6/0.1	mRBM4-6/3/D/01-UK-PT	169633	1/24
10/0.1	mRBM4-10/3/D/01-UK-PT	169634	1/24
13/0.1	mRBM4-13/3/D/01-UK-PT	169635	1/24
16/0.1	mRBM4-16/3/D/01-UK-PT	169595	1/24
20/0.1	mRBM4-20/3/D/01-UK-PT	169596	1/24
25/0.1	mRBM4-25/3/D/01-UK-PT	169597	1/24
6/0.3	mRBM4-6/3/D/03-UK-PT	169680	1/24
10/0.3	mRBM4-10/3/D/03-UK-PT	169681	1/24
13/0.3	mRBM4-13/3/D/03-UK-PT	169682	1/24
16/0.3	mRBM4-16/3/D/03-UK-PT	169683	1/24
20/0.3	mRBM4-20/3/D/03-UK-PT	169684	1/24
25/0.3	mRBM4-25/3/D/03-UK-PT	169685	1/24

SG08210



Description

- High-quality residual current device / miniature circuit breaker combination, line voltage-independent
- Version -PT specific for applications in the BS-distribution systems, permanently connected neutral conductors
- Contact position indicator red - green
- Fault current tripping indicator white - blue
- Guide for secure terminal connection
- 3-position DIN rail clip, permits removal from existing busbar system
- Comprehensive range of accessories can be mounted subsequently
- Wide variety of rated tripping currents
- Rated currents up to 32 A
- Tripping characteristics B, C, D
- Rated breaking capacity 6 kA

1.4

Combined RCD/MCB Devices

xPole

Combined RCD/MCB Devices mRB64-PT, 3+N-pole

$I_n/I_{\Delta n}$
(A)

Type
Designation

Article No.

Units per
package

Type A

6 kA, 3+N-pole

Conditionally surge current-proof 250 A, sensitive to residual pulsating DC, type A

Characteristic B

10/0.03	mRB64-10/3/B/003-A-PT	149567	1/24
13/0.03	mRB64-13/3/B/003-A-PT	149568	1/24
16/0.03	mRB64-16/3/B/003-A-PT	149569	1/24
20/0.03	mRB64-20/3/B/003-A-PT	149570	1/24
10/0.1	mRB64-10/3/B/01-A-PT	149601	1/24
13/0.1	mRB64-13/3/B/01-A-PT	149602	1/24
16/0.1	mRB64-16/3/B/01-A-PT	149603	1/24
20/0.1	mRB64-20/3/B/01-A-PT	149604	1/24
10/0.3	mRB64-10/3/B/03-A-PT	149635	1/24
13/0.3	mRB64-13/3/B/03-A-PT	149636	1/24
16/0.3	mRB64-16/3/B/03-A-PT	149637	1/24
20/0.3	mRB64-20/3/B/03-A-PT	149638	1/24

Characteristic C

6/0.03	mRB64-6/3/C/003-A-PT	149571	1/24
10/0.03	mRB64-10/3/C/003-A-PT	149572	1/24
13/0.03	mRB64-13/3/C/003-A-PT	149573	1/24
16/0.03	mRB64-16/3/C/003-A-PT	149574	1/24
20/0.03	mRB64-20/3/C/003-A-PT	149575	1/24
25/0.03	mRB64-25/3/C/003-A-PT	149576	1/24
32/0.03	mRB64-32/3/C/003-A-PT	149577	1/24
6/0.1	mRB64-6/3/C/01-A-PT	149605	1/24
10/0.1	mRB64-10/3/C/01-A-PT	149606	1/24
13/0.1	mRB64-13/3/C/01-A-PT	149607	1/24
16/0.1	mRB64-16/3/C/01-A-PT	149608	1/24
20/0.1	mRB64-20/3/C/01-A-PT	149609	1/24
25/0.1	mRB64-25/3/C/01-A-PT	149610	1/24
32/0.1	mRB64-32/3/C/01-A-PT	149611	1/24
6/0.3	mRB64-6/3/C/03-A-PT	149639	1/24
10/0.3	mRB64-10/3/C/03-A-PT	149640	1/24
13/0.3	mRB64-13/3/C/03-A-PT	149641	1/24
16/0.3	mRB64-16/3/C/03-A-PT	149642	1/24
20/0.3	mRB64-20/3/C/03-A-PT	149643	1/24
25/0.3	mRB64-25/3/C/03-A-PT	149644	1/24
32/0.3	mRB64-32/3/C/03-A-PT	149645	1/24

Characteristic D

6/0.03	mRB64-6/3/D/003-A-PT	149578	1/24
10/0.03	mRB64-10/3/D/003-A-PT	149579	1/24
13/0.03	mRB64-13/3/D/003-A-PT	149580	1/24
16/0.03	mRB64-16/3/D/003-A-PT	149581	1/24
20/0.03	mRB64-20/3/D/003-A-PT	149582	1/24
25/0.03	mRB64-25/3/D/003-A-PT	149583	1/24
6/0.1	mRB64-6/3/D/01-A-PT	149612	1/24
10/0.1	mRB64-10/3/D/01-A-PT	149613	1/24
13/0.1	mRB64-13/3/D/01-A-PT	149614	1/24
16/0.1	mRB64-16/3/D/01-A-PT	149615	1/24
20/0.1	mRB64-20/3/D/01-A-PT	149616	1/24
25/0.1	mRB64-25/3/D/01-A-PT	149617	1/24
6/0.3	mRB64-6/3/D/03-A-PT	149646	1/24
10/0.3	mRB64-10/3/D/03-A-PT	149647	1/24
13/0.3	mRB64-13/3/D/03-A-PT	149648	1/24
16/0.3	mRB64-16/3/D/03-A-PT	149649	1/24
20/0.3	mRB64-20/3/D/03-A-PT	149650	1/24
25/0.3	mRB64-25/3/D/03-A-PT	149651	1/24

SG08210



SG08210



SG08210



$I_n/I_{\Delta n}$ (A)	Type Designation	Article No.	Units per package
---------------------------	---------------------	-------------	----------------------

Type AC

6 kA, 3+N-pole
Conditionally surge current-proof 250 A, type AC

SG08210



Characteristic B

10/0.03	mRB64-10/3/B/003-PT	149584	1/24
13/0.03	mRB64-13/3/B/003-PT	149585	1/24
16/0.03	mRB64-16/3/B/003-PT	149586	1/24
20/0.03	mRB64-20/3/B/003-PT	149587	1/24
10/0.1	mRB64-10/3/B/01-PT	149618	1/24
13/0.1	mRB64-13/3/B/01-PT	149619	1/24
16/0.1	mRB64-16/3/B/01-PT	149620	1/24
20/0.1	mRB64-20/3/B/01-PT	149621	1/24
10/0.3	mRB64-10/3/B/03-PT	149652	1/24
13/0.3	mRB64-13/3/B/03-PT	149653	1/24
16/0.3	mRB64-16/3/B/03-PT	149654	1/24
20/0.3	mRB64-20/3/B/03-PT	149655	1/24

SG08210



Characteristic C

6/0.03	mRB64-6/3/C/003-PT	149588	1/24
10/0.03	mRB64-10/3/C/003-PT	149589	1/24
13/0.03	mRB64-13/3/C/003-PT	149590	1/24
16/0.03	mRB64-16/3/C/003-PT	149591	1/24
20/0.03	mRB64-20/3/C/003-PT	149592	1/24
25/0.03	mRB64-25/3/C/003-PT	149593	1/24
32/0.03	mRB64-32/3/C/003-PT	149594	1/24
6/0.1	mRB64-6/3/C/01-PT	149622	1/24
10/0.1	mRB64-10/3/C/01-PT	149623	1/24
13/0.1	mRB64-13/3/C/01-PT	149624	1/24
16/0.1	mRB64-16/3/C/01-PT	149625	1/24
20/0.1	mRB64-20/3/C/01-PT	149626	1/24
25/0.1	mRB64-25/3/C/01-PT	149627	1/24
32/0.1	mRB64-32/3/C/01-PT	149628	1/24
6/0.3	mRB64-6/3/C/03-PT	149656	1/24
10/0.3	mRB64-10/3/C/03-PT	149657	1/24
13/0.3	mRB64-13/3/C/03-PT	149658	1/24
16/0.3	mRB64-16/3/C/03-PT	149659	1/24
20/0.3	mRB64-20/3/C/03-PT	149660	1/24
25/0.3	mRB64-25/3/C/03-PT	149661	1/24
32/0.3	mRB64-32/3/C/03-PT	149662	1/24

SG08210



Characteristic D

6/0.03	mRB64-6/3/D/003-PT	149595	1/24
10/0.03	mRB64-10/3/D/003-PT	149596	1/24
13/0.03	mRB64-13/3/D/003-PT	149597	1/24
16/0.03	mRB64-16/3/D/003-PT	149598	1/24
20/0.03	mRB64-20/3/D/003-PT	149599	1/24
25/0.03	mRB64-25/3/D/003-PT	149600	1/24
6/0.1	mRB64-6/3/D/01-PT	149629	1/24
10/0.1	mRB64-10/3/D/01-PT	149630	1/24
13/0.1	mRB64-13/3/D/01-PT	149631	1/24
16/0.1	mRB64-16/3/D/01-PT	149632	1/24
20/0.1	mRB64-20/3/D/01-PT	149633	1/24
25/0.1	mRB64-25/3/D/01-PT	149634	1/24
6/0.3	mRB64-6/3/D/03-PT	149663	1/24
10/0.3	mRB64-10/3/D/03-PT	149664	1/24
13/0.3	mRB64-13/3/D/03-PT	149665	1/24
16/0.3	mRB64-16/3/D/03-PT	149666	1/24
20/0.3	mRB64-20/3/D/03-PT	149667	1/24
25/0.3	mRB64-25/3/D/03-PT	149668	1/24

Specifications | Combined RCD/MCB Devices mRBM4-PT, mRBM4-UK-PT, mRB64-PT, 3+N-pole

Description

- Combined RCD/MCB Devices
- Line voltage-independent tripping
- Compatible with standard busbar
- Twin-purpose terminal (lift/open-mouthed) above and below
- Busbar positioning optionally above or below
- Free terminal space despite installed busbar
- Guide for secure terminal connection
- Switching toggle (MCB component) in colour designating the rated current
- Contact position indicator red - green
- Fault current tripping indicator white - blue
- Comprehensive range of accessories can be mounted subsequently
- This compact protective device is specific for applications in the BS-distribution produced. Permanently connected neutral conductors (I = 950 mm, Ø = 6 mm²)
- The test key "T" must be pressed every 6 month. The system operator must be informed of this obligation and his responsibility in a way that can be proven (self-adhesive RCD-label enclosed). The test intervall of 6 month is valid for residential and similar applications. Under all other conditions (e.g. damply or dusty environments), it's recommended to test in shorter intervalls (e.g. monthly).
- Pressing the test key "T" serves the only purpose of function testing the residual current device (RCD). This test does not make earthing resistance measurement (R_E), or proper checking of the earth conductor condition redundant, which must be performed separately.

Accessories:

Tripping signal switch for subsequent installation	ZP-IHK	286052
	ZP-NHK	248437
	ZP-WHK	286053
Shunt trip release	ZP-ASA/..	248438, 248439

Technical Data

		mRBM4-PT, mRBM4-UK-PT, mRB64-PT, 3+N-pole
Electrical		
Design according to		IEC/EN 61009
Current test marks as printed onto the device		
Line voltage-independent tripping		instantaneous 250 A (8/20 μ s), surge current proof
Rated voltage	U_e	230/400 V; 50 Hz
Rated tripping current	$I_{\Delta n}$	30, 100, 300 mA
Rated non-tripping current	$I_{\Delta no}$	0.5 $I_{\Delta n}$
Sensitivity		AC and pulsating DC
Selectivity class		3
Rated breaking capacity	I_{cn}	
mRBM4-PT		10 kA
mRBM4-UK-PT		10 kA
mRB64-PT		6 kA
Rated current		6 - 32 A
Rated impulse withstand voltage	U_{imp}	4 kV (1.2/50 μ s)
Characteristic		B, C, D
Maximum back-up fuse (short-circuit)		100 A gL/gG
Endurance		
electrical components		$\geq 4,000$ switching operations
mechanical components		$\geq 20,000$ switching operations
Mechanical		
Frame size		45 mm
Device height		80 mm
Device width		70 mm (4 MU)
Mounting		3-position DIN rail clip, permits removal from existing busbar system
Degree of protection, switch		IP20
Degree of protection, built-in		IP40
Upper and lower terminals		open-mouthed/lift terminals
Terminal protection		finger and hand touch safe, DGUV VS3, EN 50274
Terminal capacity		1 - 25 mm ²
Terminal torque		2 - 2.4 Nm
Busbar thickness		0.8 - 2 mm
Operating temperature		-25°C to +40°C
Storage- and transport temperature		-35°C to +60°C
Resistance to climatic conditions		according to IEC/EN 61009

Connection diagram

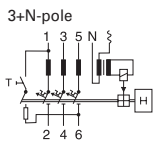

Dimensions (mm)

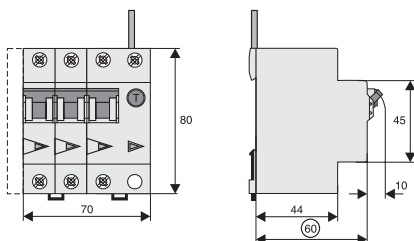

wa_sg122219_1



Description

- High-quality residual current device / miniature circuit breaker combination, line voltage-dependent
- Increased protection in applications with 1-phase frequency converter due to the detection of mixed frequencies
- Reduction of nuisance tripping thanks to
 - time delayed tripping
 - increased current withstand capability 3 kA
- Higher load rating with DC residual currents up to 10 mA (Type F)
- Contact position indicator red - green
- Fault current tripping indicator white - blue
- Guide for secure terminal connection
- 3-position DIN rail clip, permits removal from existing busbar system
- Comprehensive range of accessories can be mounted subsequently
- Wide variety of rated tripping currents
- Rated currents up to 25 A
- Tripping characteristics B, C, D
- Rated breaking capacity 10 kA

$I_n/I_{\Delta n}$ (A)	Type Designation	Article No.	Units per package
---------------------------	---------------------	-------------	----------------------

Type F

10 kA, 1+N-pole

Surge current-proof 3 kA, sensitive to residual pulsating DC, type F

wa_sg122219_1



Characteristic B

10/0.01	dRBM-10/1N/B/001-F	300408	1/60
13/0.01	dRBM-13/1N/B/001-F	300427	1/60
16/0.01	dRBM-16/1N/B/001-F	300445	1/60
10/0.03	dRBM-10/1N/B/003-F	300409	1/60
13/0.03	dRBM-13/1N/B/003-F	300428	1/60
16/0.03	dRBM-16/1N/B/003-F	300446	1/60
10/0.1	dRBM-10/1N/B/01-F	300407	1/60
13/0.1	dRBM-13/1N/B/01-F	300426	1/60
16/0.1	dRBM-16/1N/B/01-F	300444	1/60

Characteristic C

6/0.01	dRBM-6/1N/C/001-F	300393	1/60
10/0.01	dRBM-10/1N/C/001-F	300411	1/60
13/0.01	dRBM-13/1N/C/001-F	300430	1/60
16/0.01	dRBM-16/1N/C/001-F	300448	1/60
20/0.01	dRBM-20/1N/C/001-F	300460	1/60
25/0.01	dRBM-25/1N/C/001-F	300475	1/60
6/0.03	dRBM-6/1N/C/003-F	300394	1/60
10/0.03	dRBM-10/1N/C/003-F	300412	1/60
13/0.03	dRBM-13/1N/C/003-F	300431	1/60
16/0.03	dRBM-16/1N/C/003-F	300449	1/60
20/0.03	dRBM-20/1N/C/003-F	300461	1/60
25/0.03	dRBM-25/1N/C/003-F	300476	1/60
6/0.1	dRBM-6/1N/C/01-F	300392	1/60
10/0.1	dRBM-10/1N/C/01-F	300410	1/60
13/0.1	dRBM-13/1N/C/01-F	300429	1/60
16/0.1	dRBM-16/1N/C/01-F	300447	1/60
20/0.1	dRBM-20/1N/C/01-F	300459	1/60
25/0.1	dRBM-25/1N/C/01-F	300474	1/60

Characteristic D

6/0.01	dRBM-6/1N/D/001-F	300396	1/60
10/0.01	dRBM-10/1N/D/001-F	300414	1/60
13/0.01	dRBM-13/1N/D/001-F	300433	1/60
16/0.01	dRBM-16/1N/D/001-F	300451	1/60
20/0.01	dRBM-20/1N/D/001-F	300463	1/60
25/0.01	dRBM-25/1N/D/001-F	300478	1/60
6/0.03	dRBM-6/1N/D/003-F	300397	1/60
10/0.03	dRBM-10/1N/D/003-F	300415	1/60
13/0.03	dRBM-13/1N/D/003-F	300434	1/60
16/0.03	dRBM-16/1N/D/003-F	300452	1/60
20/0.03	dRBM-20/1N/D/003-F	300466	1/60
25/0.03	dRBM-25/1N/D/003-F	300479	1/60
6/0.1	dRBM-6/1N/D/01-F	300395	1/60
10/0.1	dRBM-10/1N/D/01-F	300413	1/60
13/0.1	dRBM-13/1N/D/01-F	300432	1/60
16/0.1	dRBM-16/1N/D/01-F	300450	1/60
20/0.1	dRBM-20/1N/D/01-F	300462	1/60
25/0.1	dRBM-25/1N/D/01-F	300477	1/60



wa_sg106719_1

$I_n/I_{\Delta n}$ (A)	Type Designation	Article No.	Units per package
---------------------------	---------------------	-------------	----------------------

Type F

10 kA, 2-pole

Surge current-proof 3 kA, sensitive to residual pulsating DC, type F

Characteristic B

10/0.01	dRBM-10/2/B/001-F	300399	1/60
13/0.01	dRBM-13/2/B/001-F	300417	1/60
16/0.01	dRBM-16/2/B/001-F	300436	1/60
10/0.03	dRBM-10/2/B/003-F	300400	1/60
13/0.03	dRBM-13/2/B/003-F	300419	1/60
16/0.03	dRBM-16/2/B/003-F	300437	1/60
10/0.1	dRBM-10/2/B/01-F	300398	1/60
13/0.1	dRBM-13/2/B/01-F	300416	1/60
16/0.1	dRBM-16/2/B/01-F	300435	1/60

Characteristic C

6/0.01	dRBM-6/2/C/001-F	300386	1/60
10/0.01	dRBM-10/2/C/001-F	300402	1/60
13/0.01	dRBM-13/2/C/001-F	300421	1/60
16/0.01	dRBM-16/2/C/001-F	300439	1/60
20/0.01	dRBM-20/2/C/001-F	300454	1/60
25/0.01	dRBM-25/2/C/001-F	300468	1/60
6/0.03	dRBM-6/2/C/003-F	300387	1/60
10/0.03	dRBM-10/2/C/003-F	300403	1/60
13/0.03	dRBM-13/2/C/003-F	300422	1/60
16/0.03	dRBM-16/2/C/003-F	300440	1/60
20/0.03	dRBM-20/2/C/003-F	300455	1/60
25/0.03	dRBM-25/2/C/003-F	300469	1/60
6/0.1	dRBM-6/2/C/01-F	300382	1/60
10/0.1	dRBM-10/2/C/01-F	300401	1/60
13/0.1	dRBM-13/2/C/01-F	300420	1/60
16/0.1	dRBM-16/2/C/01-F	300438	1/60
20/0.1	dRBM-20/2/C/01-F	300453	1/60
25/0.1	dRBM-25/2/C/01-F	300467	1/60

Characteristic D

6/0.01	dRBM-6/2/D/001-F	300390	1/60
10/0.01	dRBM-10/2/D/001-F	300405	1/60
13/0.01	dRBM-13/2/D/001-F	300424	1/60
16/0.01	dRBM-16/2/D/001-F	300442	1/60
20/0.01	dRBM-20/2/D/001-F	300457	1/60
25/0.01	dRBM-25/2/D/001-F	300472	1/60
6/0.03	dRBM-6/2/D/003-F	300391	1/60
10/0.03	dRBM-10/2/D/003-F	300406	1/60
13/0.03	dRBM-13/2/D/003-F	300425	1/60
16/0.03	dRBM-16/2/D/003-F	300443	1/60
20/0.03	dRBM-20/2/D/003-F	300458	1/60
25/0.03	dRBM-25/2/D/003-F	300473	1/60
6/0.1	dRBM-6/2/D/01-F	300389	1/60
10/0.1	dRBM-10/2/D/01-F	300404	1/60
13/0.1	dRBM-13/2/D/01-F	300423	1/60
16/0.1	dRBM-16/2/D/01-F	300441	1/60
20/0.1	dRBM-20/2/D/01-F	300456	1/60
25/0.1	dRBM-25/2/D/01-F	300471	1/60

Specifications | Combined RCD/MCB Devices dRBM, digital

Description

- Combined RCD/MCB device
- Line voltage-dependent tripping
- Compatible with standard busbar
- Twin-purpose terminal (lift/open-mouthed) above and below
- Busbar positioning optionally above or below
- Free terminal space despite installed busbar
- Guide for secure terminal connection
- Contact position indicator red - green
- Fault current tripping indicator white - blue
- Comprehensive range of accessories suitable for subsequent installation
- The test key "T" must be pressed every year. The system operator must be informed of this obligation and his responsibility in a way that can be proven. Under special conditions (e.g. damply and/or dusty environments, environments with polluting and/or corroding conditions, environments with large temperature fluctuations, installations with a risk of overvoltages due to switching of equipment and/or atmospheric discharges, portable equipment ...), it's recommended to test in monthly intervals.
- Pressing the test key "T" serves the only purpose of function testing the residual current device (RCD). This test does not make earthing resistance measurement (R_E), or proper checking of the earth conductor condition redundant, which must be performed separately.
- **Type -F:** Sensitive to pulsating DC residual current and detection of multi-frequency residual currents up to 1 kHz
 - Increased protection due to the detection of mixed frequencies
 - Higher load rating with DC residual currents up to 10 mA
 - Reduction of nuisance tripping thanks to time delayed tripping and increased current withstand capability of 3 kA
 Recommended for washing machines, dish washers or motor applications with single-phase drives.

Accessories:

Auxiliary switch for subsequent installation	ZP-IHK	286052
	ZP-WHK	286053
Tripping signal switch for subsequent installation	ZP-NHK	248437
Shunt trip release	ZP-ASA/..	248438, 248439

Local Indication RCD

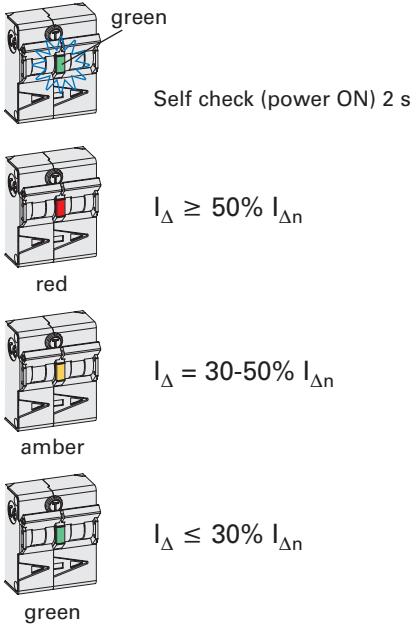

Service Mode (measuring of residual current I_{Δ})

Pressing test button twice to activate Service-Mode



Measurement delimiter	red
Measurement delimiter ON time	400 ms
10 mA measurement color	amber
1 mA measurement color	green
Double-pressing test button to activate Service Mode	press (0.1-0.4 s) -> release (0.1-0.4 s) -> press (0.1-0.4 s)
Time duration of Service Mode	4 min (during activated Service Mode all protection functions are still working)

Lamp test

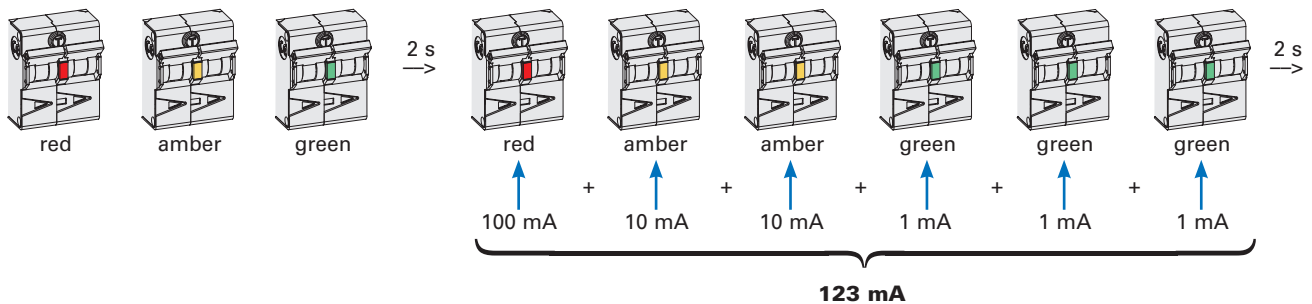

Technical Data

		dRBM
Electrical		
Design according to		IEC/EN 61009 Type G according to ÖVE E 8601
Current test marks as printed onto the device		
Number of protected poles		
1+N		1
2-pole		2
Tripping		
Type F		line voltage-dependent, 10 ms delay, 3 kA (8/20µs) surge current-proof
Rated voltage	U_n	240 V AC, 50 Hz
Rated operational voltage	U_e	204-260 V AC
Voltage range test circuit		195-264 V AC
Rated tripping current	$I_{\Delta n}$	30, 100 mA
Rated non-tripping current	$I_{\Delta no}$	0.55 $I_{\Delta n}$
Sensitivity		AC and pulsating DC, Type F according to IEC 62423
Press of test button duration		> 0.5 s
Selectivity class		3
Service short-circuit capacity	I_{cs}	7.5 kA
Rated short-circuit capacity	I_{cn}	10 kA
Rated current		6 - 25 A
Rated impulse withstand voltage	U_{imp}	4 kV (1.2/50µs)
Characteristic		B, C, D
Maximum back-up fuse (short-circuit protection)		100 A gL (>10 kA)
Endurance		
electrical components		≥ 4,000 operating cycles ($I_n, U_n, \cos\phi = 0.87$)
mechanical components		≥ 10,000 operating cycles
Mechanical		
Frame size		45 mm
Device height		80 mm
Device width		35 mm (2 MU)
Mounting		3-position DIN rail clip, permits removal from existing busbar system
Degree of protection switch		IP20
Degree of protection, built-in		IP40
Upper and lower terminals		open-mouthed/lift terminals
Terminal protection		finger and hand touch safe, DGUV VS3, EN 50274
Terminal capacity		1 - 25 mm ²
Terminal screw		M5 (with slotted screw acc. to EN ISO 4757-Z2, Pozidriv PZ2)
Terminal torque		2 - 2.4 Nm
Busbar thickness		0.8 - 2 mm
Operation temperature		-25°C to +40°C
Storage- and transport temperature		-35°C to +60°C
Resistance to climatic conditions		acc. to IEC 68-2 (25..55°C / 90..95% RH)
Line side (supply)		lower terminals
Load side		upper terminals

Connection diagram

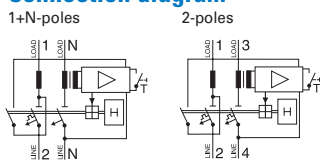

Dimensions (mm)

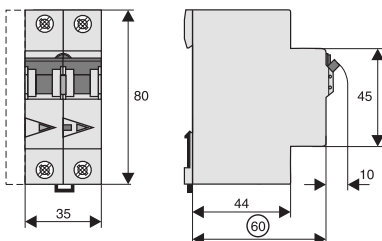

Tripping Characteristic dRBM

Tripping Characteristic dRBM, Characteristics B, C and D

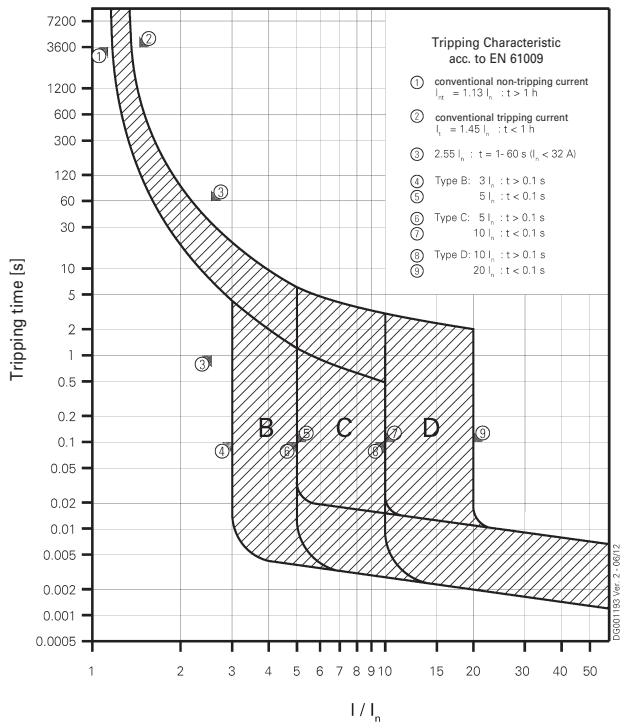

Internal Resistance dRBM

Type B

At room temperature (single pole)

I_n [A]	R^* [mΩ]
10	17.9
13	12.3
16	7.6

* 50Hz

Type C

At room temperature (single pole)

I_n [A]	R^* [mΩ]
6	28.5
10	17.7
13	9.0
16	6.7
20	5.5
25	3.0

* 50Hz

Type D

At room temperature (single pole)

I_n [A]	R^* [mΩ]
6	28.5
10	14.9
13	9.0
16	6.7
20	5.5
25	3.0

* 50Hz

Power Loss at I_n dRBM

Type B

(entire unit)

I_n [A]	P^* [W]
10	4.0
13	4.9
16	4.5

* 50Hz and ambient temperature

Type C

(entire unit)

I_n [A]	P^* [W]
6	2.1
10	4.0
13	3.4
16	3.9
20	5.0
25	4.2

* 50Hz and ambient temperature

Type D

(entire unit)

I_n [A]	P^* [W]
6	2.1
10	3.2
13	3.4
16	3.9
20	5.0
25	4.2

* 50Hz and ambient temperature

Let-through Energy dRBM

Let-through Energy dRBM, Characteristic B

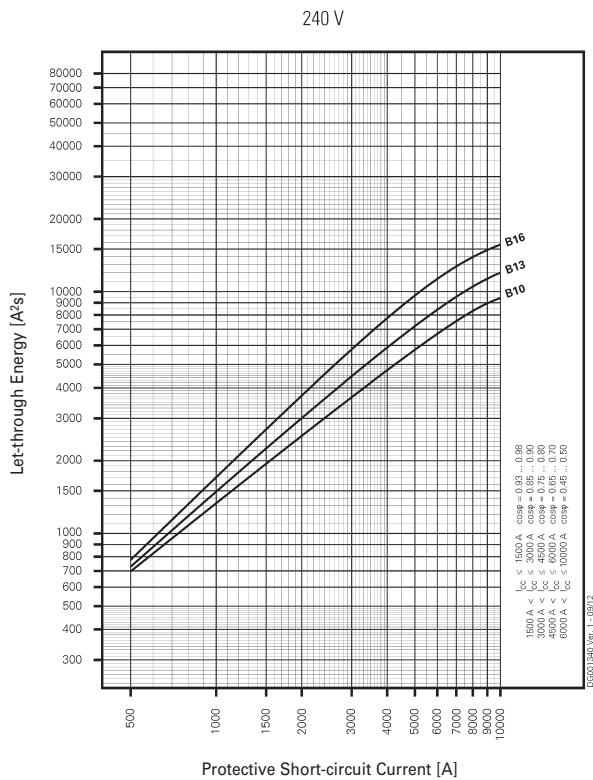

Let-through Energy dRBM, Characteristic C

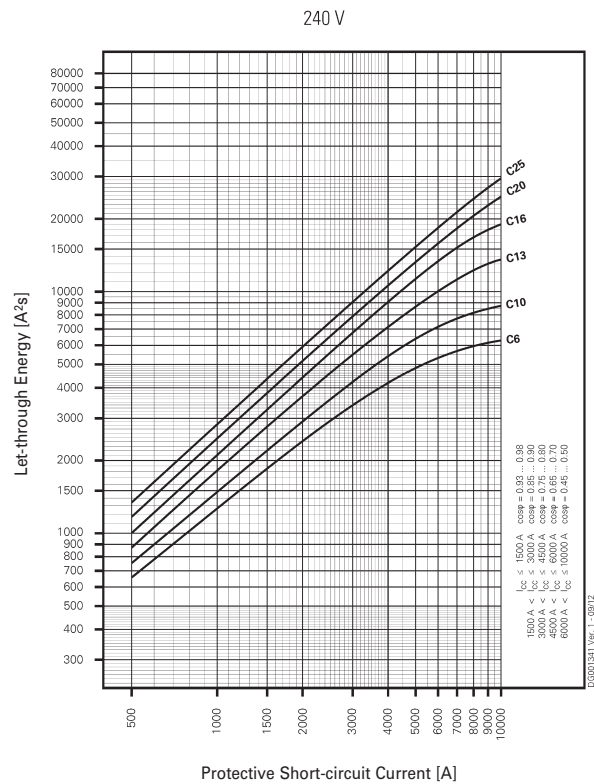

Let-through Energy dRBM, Characteristic D

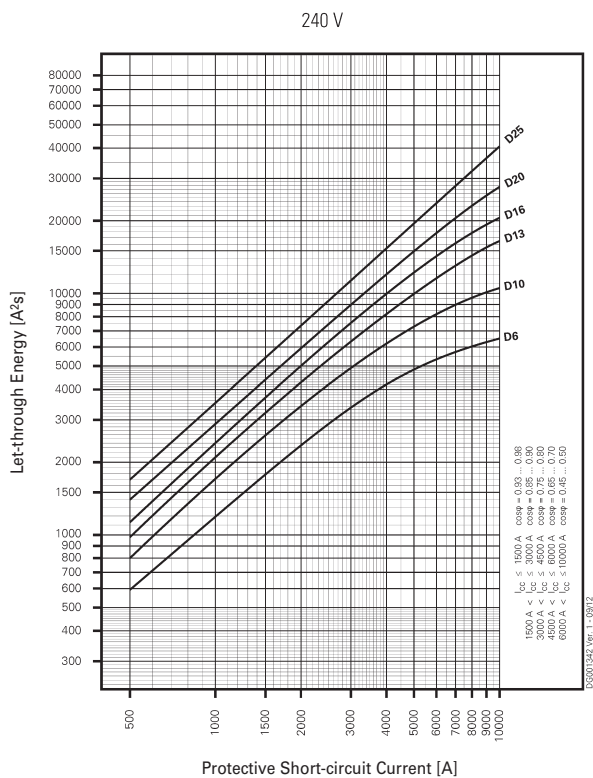

Let-through Current dRBM

Let-through Current dRBM, Characteristic B

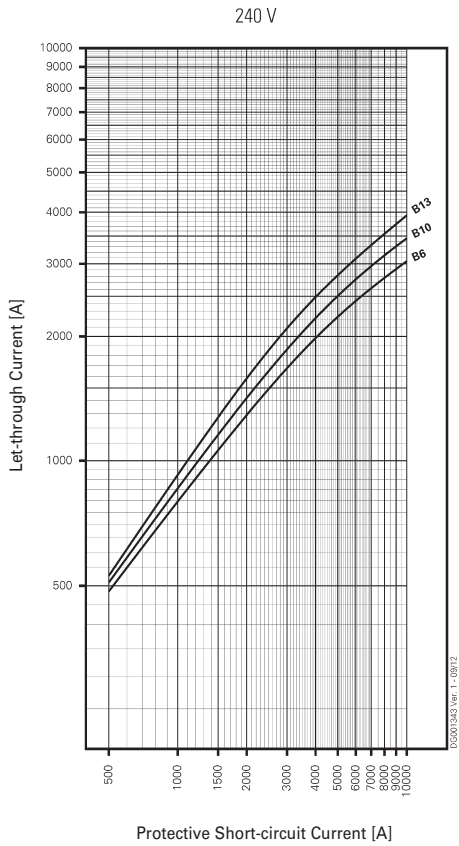

Let-through Current dRBM, Characteristic C

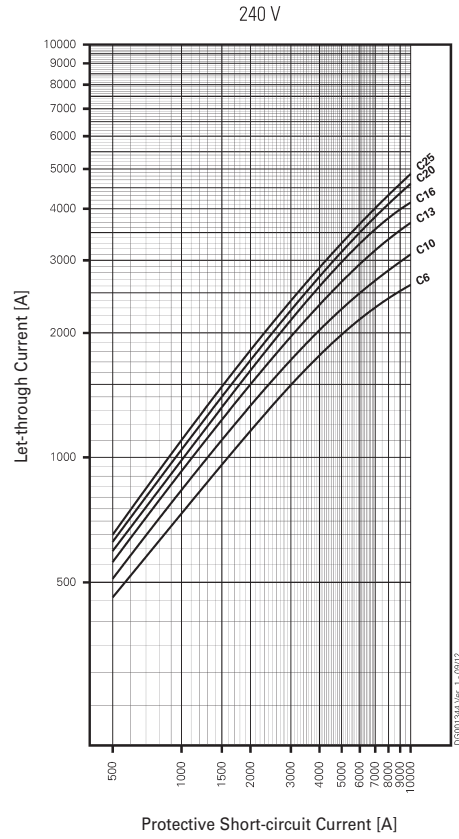

Let-through Current dRBM, Characteristic D

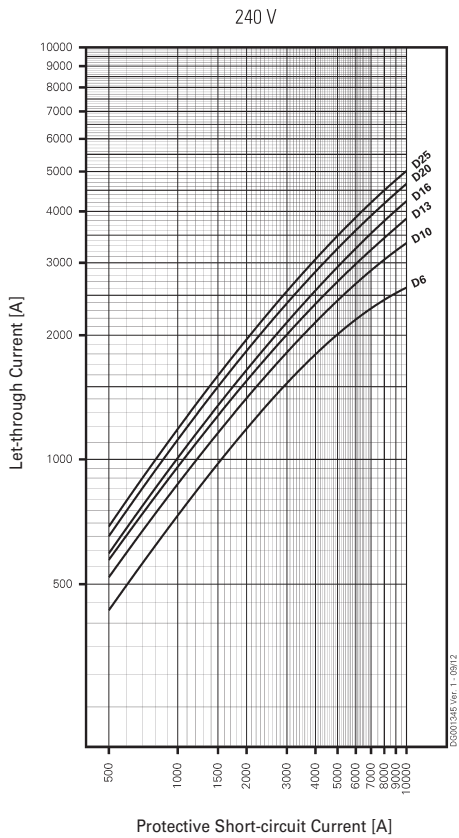

SG67811



Description

- High-quality miniature circuit breakers for commercial and residential applications
- Contact position indicator red - green
- Guide for secure terminal connection
- 3-position DIN rail clip, permits removal from existing busbar system
- Comprehensive range of accessories can be mounted subsequently
- Rated currents up to 63 A
- Tripping characteristics B, C, D
- Rated breaking capacity 10 kA according to IEC/EN 60898-1

Rated current I_n (A)	Type Designation	Article No.	Units per package
----------------------------	---------------------	-------------	----------------------

10 kA, Characteristic B

SG48411



1-pole

6	PLSM-B6	242174	12/120
10	PLSM-B10	242176	12/120
13	PLSM-B13	242178	12/120
16	PLSM-B16	242180	12/120
20	PLSM-B20	242181	12/120
25	PLSM-B25	242182	12/120
32	PLSM-B32	242183	12/120
40	PLSM-B40	242184	12/120
50	PLSM-B50	242185	12/120
63	PLSM-B63	242186	12/120

SG49211



1+N-pole 1.5MU

6	PLSM-B6/1N	242243	8/80
10	PLSM-B10/1N	242245	8/80
13	PLSM-B13/1N	242247	8/80
16	PLSM-B16/1N	242249	8/80
20	PLSM-B20/1N	242250	8/80
25	PLSM-B25/1N	242251	8/80
32	PLSM-B32/1N	242252	8/80

1.5

Miniature Circuit Breakers (MCBs)

xPole

Miniature Circuit Breakers PLSM, PLZM (MW)

SG52711



Rated current I_n (A)	Type Designation	Article No.	Units per package
1+N-pole 2 MU			
6	PLZM-B6/1N	242304	1/60
10	PLZM-B10/1N	242306	1/60
13	PLZM-B13/1N	242308	1/60
16	PLZM-B16/1N	242310	1/60
20	PLZM-B20/1N	242311	1/60
25	PLZM-B25/1N	242312	1/60
32	PLZM-B32/1N	242313	1/60
40	PLZM-B40/1N	242314	1/60
50	PLZM-B50/1N	242315	1/60
63	PLZM-B63/1N	242316	1/60

SG54811



Rated current I_n (A)	Type Designation	Article No.	Units per package
2-pole			
6	PLSM-B6/2	242373	1/60
10	PLSM-B10/2	242375	1/60
13	PLSM-B13/2	242377	1/60
16	PLSM-B16/2	242379	1/60
20	PLSM-B20/2	242380	1/60
25	PLSM-B25/2	242381	1/60
32	PLSM-B32/2	242382	1/60
40	PLSM-B40/2	242383	1/60
50	PLSM-B50/2	242384	1/60
63	PLSM-B63/2	242385	1/60

SG63111



Rated current I_n (A)	Type Designation	Article No.	Units per package
3-pole			
6	PLSM-B6/3	242442	1/40
10	PLSM-B10/3	242444	1/40
13	PLSM-B13/3	242446	1/40
16	PLSM-B16/3	242448	1/40
20	PLSM-B20/3	242449	1/40
25	PLSM-B25/3	242450	1/40
32	PLSM-B32/3	242451	1/40
40	PLSM-B40/3	242452	1/40
50	PLSM-B50/3	242453	1/40
63	PLSM-B63/3	242454	1/40

SG65611



Rated current I_n (A)	Type Designation	Article No.	Units per package
3+N-pole			
6	PLSM-B6/3N	242511	1/30
10	PLSM-B10/3N	242513	1/30
13	PLSM-B13/3N	242515	1/30
16	PLSM-B16/3N	242517	1/30
20	PLSM-B20/3N	242518	1/30
25	PLSM-B25/3N	242519	1/30
32	PLSM-B32/3N	242520	1/30
40	PLSM-B40/3N	242521	1/30
50	PLSM-B50/3N	242522	1/30
63	PLSM-B63/3N	242523	1/30

1.5

Miniature Circuit Breakers (MCBs)

xPole

Miniature Circuit Breakers PLSM, PLZM (MW)

SG67811



Rated current I_n (A)	Type Designation	Article No.	Units per package
4-pole			
6	PLSM-B6/4	242580	1/30
10	PLSM-B10/4	242582	1/30
13	PLSM-B13/4	242584	1/30
16	PLSM-B16/4	242586	1/30
20	PLSM-B20/4	242587	1/30
25	PLSM-B25/4	242588	1/30
32	PLSM-B32/4	242589	1/30
40	PLSM-B40/4	242590	1/30
50	PLSM-B50/4	242591	1/30
63	PLSM-B63/4	242592	1/30

SG48411



Rated current I_n (A)	Type Designation	Article No.	Units per package
----------------------------	---------------------	-------------	----------------------

10 kA, Characteristic C

1-pole

6	PLSM-C6	242200	12/120
10	PLSM-C10	242202	12/120
13	PLSM-C13	242204	12/120
16	PLSM-C16	242206	12/120
20	PLSM-C20	242207	12/120
25	PLSM-C25	242208	12/120
32	PLSM-C32	242209	12/120
40	PLSM-C40	242210	12/120
50	PLSM-C50	242211	12/120
63	PLSM-C63	242212	12/120

SG49211



1+N-pole 1.5MU

6	PLSM-C6/1N	242266	8/80
10	PLSM-C10/1N	242268	8/80
13	PLSM-C13/1N	242270	8/80
16	PLSM-C16/1N	242272	8/80
20	PLSM-C20/1N	242273	8/80
25	PLSM-C25/1N	242274	8/80
32	PLSM-C32/1N	242275	8/80

1.5

Miniature Circuit Breakers (MCBs)

xPole

Miniature Circuit Breakers PLSM, PLZM (MW)

SG52711



Rated current I_n (A)	Type Designation	Article No.	Units per package
1+N-pole 2 MU			
6	PLZM-C6/1N	242330	1/60
10	PLZM-C10/1N	242332	1/60
13	PLZM-C13/1N	242334	1/60
16	PLZM-C16/1N	242336	1/60
20	PLZM-C20/1N	242337	1/60
25	PLZM-C25/1N	242338	1/60
32	PLZM-C32/1N	242339	1/60
40	PLZM-C40/1N	242340	1/60
50	PLZM-C50/1N	242341	1/60
63	PLZM-C63/1N	242342	1/60

SG54811



Rated current I_n (A)	Type Designation	Article No.	Units per package
2-pole			
6	PLSM-C6/2	242399	1/60
10	PLSM-C10/2	242401	1/60
13	PLSM-C13/2	242403	1/60
16	PLSM-C16/2	242405	1/60
20	PLSM-C20/2	242406	1/60
25	PLSM-C25/2	242407	1/60
32	PLSM-C32/2	242408	1/60
40	PLSM-C40/2	242409	1/60
50	PLSM-C50/2	242410	1/60
63	PLSM-C63/2	242411	1/60

SG63111



Rated current I_n (A)	Type Designation	Article No.	Units per package
3-pole			
6	PLSM-C6/3	242468	1/40
10	PLSM-C10/3	242470	1/40
13	PLSM-C13/3	242472	1/40
16	PLSM-C16/3	242474	1/40
20	PLSM-C20/3	242475	1/40
25	PLSM-C25/3	242476	1/40
32	PLSM-C32/3	242477	1/40
40	PLSM-C40/3	242478	1/40
50	PLSM-C50/3	242479	1/40
63	PLSM-C63/3	242480	1/40

SG65611



Rated current I_n (A)	Type Designation	Article No.	Units per package
3+N-pole			
6	PLSM-C6/3N	242537	1/30
10	PLSM-C10/3N	242539	1/30
13	PLSM-C13/3N	242541	1/30
16	PLSM-C16/3N	242543	1/30
20	PLSM-C20/3N	242544	1/30
25	PLSM-C25/3N	242545	1/30
32	PLSM-C32/3N	242546	1/30
40	PLSM-C40/3N	242547	1/30
50	PLSM-C50/3N	242548	1/30
63	PLSM-C63/3N	242549	1/30

1.5

Miniature Circuit Breakers (MCBs)

xPole

Miniature Circuit Breakers PLSM, PLZM (MW)

SG67811



Rated current I_n (A)	Type Designation	Article No.	Units per package
4-pole			
6	PLSM-C6/4	242606	1/30
10	PLSM-C10/4	242608	1/30
13	PLSM-C13/4	242610	1/30
16	PLSM-C16/4	242612	1/30
20	PLSM-C20/4	242613	1/30
25	PLSM-C25/4	242614	1/30
32	PLSM-C32/4	242615	1/30
40	PLSM-C40/4	242616	1/30
50	PLSM-C50/4	242617	1/30
63	PLSM-C63/4	242618	1/30

Rated current I_n (A)	Type Designation	Article No.	Units per package
----------------------------	---------------------	-------------	----------------------

10 kA, Characteristic D

SG48411



1-pole

6	PLSM-D6	242223	12/120
10	PLSM-D10	242225	12/120
13	PLSM-D13	242227	12/120
16	PLSM-D16	242229	12/120
20	PLSM-D20	242230	12/120
25	PLSM-D25	242231	12/120
32	PLSM-D32	242232	12/120
40	PLSM-D40	242233	12/120

SG49211



1+N-pole 1.5MU

6	PLSM-D6/1N	242286	8/80
10	PLSM-D10/1N	242288	8/80
13	PLSM-D13/1N	242290	8/80
16	PLSM-D16/1N	242292	8/80
20	PLSM-D20/1N	242293	8/80
25	PLSM-D25/1N	242294	8/80

1.5

Miniature Circuit Breakers (MCBs)

xPole

Miniature Circuit Breakers PLSM, PLZM (MW)

SG52711



Rated current I_n (A)	Type Designation	Article No.	Units per package
1+N-pole 2 MU			
6	PLZM-D6/1N	242353	1/60
10	PLZM-D10/1N	242355	1/60
13	PLZM-D13/1N	242357	1/60
16	PLZM-D16/1N	242359	1/60
20	PLZM-D20/1N	242360	1/60
25	PLZM-D25/1N	242361	1/60
32	PLZM-D32/1N	242362	1/60
40	PLZM-D40/1N	242363	1/60

SG54811



Rated current I_n (A)	Type Designation	Article No.	Units per package
2-pole			
6	PLSM-D6/2	242422	1/60
10	PLSM-D10/2	242424	1/60
13	PLSM-D13/2	242426	1/60
16	PLSM-D16/2	242428	1/60
20	PLSM-D20/2	242429	1/60
25	PLSM-D25/2	242430	1/60
32	PLSM-D32/2	242431	1/60
40	PLSM-D40/2	242432	1/60

SG63111



Rated current I_n (A)	Type Designation	Article No.	Units per package
3-pole			
6	PLSM-D6/3	242491	1/40
10	PLSM-D10/3	242493	1/40
13	PLSM-D13/3	242495	1/40
16	PLSM-D16/3	242497	1/40
20	PLSM-D20/3	242498	1/40
25	PLSM-D25/3	242499	1/40
32	PLSM-D32/3	242500	1/40
40	PLSM-D40/3	242501	1/40

SG65611



Rated current I_n (A)	Type Designation	Article No.	Units per package
3+N-pole			
6	PLSM-D6/3N	242560	1/30
10	PLSM-D10/3N	242562	1/30
13	PLSM-D13/3N	242564	1/30
16	PLSM-D16/3N	242566	1/30
20	PLSM-D20/3N	242567	1/30
25	PLSM-D25/3N	242568	1/30
32	PLSM-D32/3N	242569	1/30
40	PLSM-D40/3N	242570	1/30

1.5

Miniature Circuit Breakers (MCBs)

xPole

Miniature Circuit Breakers PLSM, PLZM (MW)

SG67811



Rated current I_n (A)	Type Designation	Article No.	Units per package
4-pole			
6	PLSM-D6/4	242629	1/30
10	PLSM-D10/4	242631	1/30
13	PLSM-D13/4	242633	1/30
16	PLSM-D16/4	242635	1/30
20	PLSM-D20/4	242636	1/30
25	PLSM-D25/4	242637	1/30
32	PLSM-D32/4	242638	1/30
40	PLSM-D40/4	242639	1/30

SG72911



Description

- High-quality miniature circuit breakers for commercial and residential applications
- Contact position indicator red - green
- Guide for secure terminal connection
- 3-position DIN rail clip, permits removal from existing busbar system
- Comprehensive range of accessories can be mounted subsequently
- Rated currents up to 63 A
- Tripping characteristics B, C, D
- Rated breaking capacity 6 kA according to IEC/EN 60898-1

1.5

Miniature Circuit Breakers (MCBs)

xPole

Miniature Circuit Breakers PLS6, PLZ6 (MW)

Rated current I_n (A)	Type Designation	Article No.	Units per package
----------------------------	---------------------	-------------	----------------------

6 kA, Characteristic B

SG28911



1-pole

6	PLS6-B6	242649	12/120
10	PLS6-B10	242651	12/120
13	PLS6-B13	242653	12/120
16	PLS6-B16	242655	12/120
20	PLS6-B20	242656	12/120
25	PLS6-B25	242657	12/120
32	PLS6-B32	242658	12/120
40	PLS6-B40	242659	12/120
50	PLS6-B50	242660	12/120
63	PLS6-B63	242661	12/120

SG40111



1+N-pole 1.5MU

6	PLS6-B6/1N	242718	8/80
10	PLS6-B10/1N	242720	8/80
13	PLS6-B13/1N	242722	8/80
16	PLS6-B16/1N	242724	8/80
20	PLS6-B20/1N	242725	8/80
25	PLS6-B25/1N	242726	8/80
32	PLS6-B32/1N	242727	8/80

SG58211



Rated current I_n (A)	Type Designation	Article No.	Units per package
1+N-pole 2 MU			
6	PLZ6-B6/1N	242779	1/60
10	PLZ6-B10/1N	242781	1/60
13	PLZ6-B13/1N	242783	1/60
16	PLZ6-B16/1N	242785	1/60
20	PLZ6-B20/1N	242786	1/60
25	PLZ6-B25/1N	242787	1/60
32	PLZ6-B32/1N	242788	1/60
40	PLZ6-B40/1N	242789	1/60
50	PLZ6-B50/1N	242790	1/60
63	PLZ6-B63/1N	242791	1/60

SG77911



Rated current I_n (A)	Type Designation	Article No.	Units per package
2-pole			
6	PLS6-B6/2	242848	1/60
10	PLS6-B10/2	242850	1/60
13	PLS6-B13/2	242852	1/60
16	PLS6-B16/2	242854	1/60
20	PLS6-B20/2	242855	1/60
25	PLS6-B25/2	242856	1/60
32	PLS6-B32/2	242857	1/60
40	PLS6-B40/2	242858	1/60
50	PLS6-B50/2	242859	1/60
63	PLS6-B63/2	242860	1/60

1.5

Miniature Circuit Breakers (MCBs)

xPole

Miniature Circuit Breakers PLS6, PLZ6 (MW)

SG74311



Rated current I_n (A)	Type Designation	Article No.	Units per package
3-pole			
6	PLS6-B6/3	242917	1/40
10	PLS6-B10/3	242919	1/40
13	PLS6-B13/3	242921	1/40
16	PLS6-B16/3	242923	1/40
20	PLS6-B20/3	242924	1/40
25	PLS6-B25/3	242925	1/40
32	PLS6-B32/3	242926	1/40
40	PLS6-B40/3	242927	1/40
50	PLS6-B50/3	242928	1/40
63	PLS6-B63/3	242929	1/40

SG73911



Rated current I_n (A)	Type Designation	Article No.	Units per package
3+N-pole			
6	PLS6-B6/3N	242986	1/30
10	PLS6-B10/3N	242988	1/30
13	PLS6-B13/3N	242990	1/30
16	PLS6-B16/3N	242992	1/30
20	PLS6-B20/3N	242993	1/30
25	PLS6-B25/3N	242994	1/30
32	PLS6-B32/3N	242995	1/30
40	PLS6-B40/3N	242996	1/30
50	PLS6-B50/3N	242997	1/30
63	PLS6-B63/3N	242998	1/30

SG70011



Rated current I_n (A)	Type Designation	Article No.	Units per package
4-pole			
6	PLS6-B6/4	243055	1/30
10	PLS6-B10/4	243057	1/30
13	PLS6-B13/4	243059	1/30
16	PLS6-B16/4	243061	1/30
20	PLS6-B20/4	243062	1/30
25	PLS6-B25/4	243063	1/30
32	PLS6-B32/4	243064	1/30
40	PLS6-B40/4	243065	1/30
50	PLS6-B50/4	243066	1/30
63	PLS6-B63/4	243067	1/30

1.5

Miniature Circuit Breakers (MCBs)

xPole

Miniature Circuit Breakers PLS6, PLZ6 (MW)

Rated current I_n (A)	Type Designation	Article No.	Units per package
----------------------------	---------------------	-------------	----------------------

6 kA, Characteristic C

SG28911



1-pole

6	PLS6-C6	242675	12/120
10	PLS6-C10	242677	12/120
13	PLS6-C13	242679	12/120
16	PLS6-C16	242681	12/120
20	PLS6-C20	242682	12/120
25	PLS6-C25	242683	12/120
32	PLS6-C32	242684	12/120
40	PLS6-C40	242685	12/120
50	PLS6-C50	242686	12/120
63	PLS6-C63	242687	12/120

SG40111



1+N-pole 1.5MU

6	PLS6-C6/1N	242741	8/80
10	PLS6-C10/1N	242743	8/80
13	PLS6-C13/1N	242745	8/80
16	PLS6-C16/1N	242747	8/80
20	PLS6-C20/1N	242748	8/80
25	PLS6-C25/1N	242749	8/80
32	PLS6-C32/1N	242750	8/80

SG58211



Rated current I_n (A)	Type Designation	Article No.	Units per package
1+N-pole 2 MU			
6	PLZ6-C6/1N	242805	1/60
10	PLZ6-C10/1N	242807	1/60
13	PLZ6-C13/1N	242809	1/60
16	PLZ6-C16/1N	242811	1/60
20	PLZ6-C20/1N	242812	1/60
25	PLZ6-C25/1N	242813	1/60
32	PLZ6-C32/1N	242814	1/60
40	PLZ6-C40/1N	242815	1/60
50	PLZ6-C50/1N	242816	1/60
63	PLZ6-C63/1N	242817	1/60

SG77911



Rated current I_n (A)	Type Designation	Article No.	Units per package
2-pole			
6	PLS6-C6/2	242874	1/60
10	PLS6-C10/2	242876	1/60
13	PLS6-C13/2	242878	1/60
16	PLS6-C16/2	242880	1/60
20	PLS6-C20/2	242881	1/60
25	PLS6-C25/2	242882	1/60
32	PLS6-C32/2	242883	1/60
40	PLS6-C40/2	242884	1/60
50	PLS6-C50/2	242885	1/60
63	PLS6-C63/2	242886	1/60

1.5

Miniature Circuit Breakers (MCBs)

xPole

Miniature Circuit Breakers PLS6, PLZ6 (MW)

SG74311



Rated current I_n (A)	Type Designation	Article No.	Units per package
3-pole			
6	PLS6-C6/3	242943	1/40
10	PLS6-C10/3	242945	1/40
13	PLS6-C13/3	242947	1/40
16	PLS6-C16/3	242949	1/40
20	PLS6-C20/3	242950	1/40
25	PLS6-C25/3	242951	1/40
32	PLS6-C32/3	242952	1/40
40	PLS6-C40/3	242953	1/40
50	PLS6-C50/3	242954	1/40
63	PLS6-C63/3	242955	1/40

SG73911



Rated current I_n (A)	Type Designation	Article No.	Units per package
3+N-pole			
6	PLS6-C6/3N	243012	1/30
10	PLS6-C10/3N	243014	1/30
13	PLS6-C13/3N	243016	1/30
16	PLS6-C16/3N	243018	1/30
20	PLS6-C20/3N	243019	1/30
25	PLS6-C25/3N	243020	1/30
32	PLS6-C32/3N	243021	1/30
40	PLS6-C40/3N	243022	1/30
50	PLS6-C50/3N	243023	1/30
63	PLS6-C63/3N	243024	1/30

SG70011



Rated current I_n (A)	Type Designation	Article No.	Units per package
4-pole			
6	PLS6-C6/4	243081	1/30
10	PLS6-C10/4	243083	1/30
13	PLS6-C13/4	243085	1/30
16	PLS6-C16/4	243087	1/30
20	PLS6-C20/4	243088	1/30
25	PLS6-C25/4	243089	1/30
32	PLS6-C32/4	243090	1/30
40	PLS6-C40/4	243091	1/30
50	PLS6-C50/4	243092	1/30
63	PLS6-C63/4	243093	1/30

1.5

Miniature Circuit Breakers (MCBs)

xPole

Miniature Circuit Breakers PLS6, PLZ6 (MW)

Rated current I_n (A)	Type Designation	Article No.	Units per package
----------------------------	---------------------	-------------	----------------------

6 kA, Characteristic D

SG28911



1-pole

6	PLS6-D6	242698	12/120
10	PLS6-D10	242700	12/120
13	PLS6-D13	242702	12/120
16	PLS6-D16	242704	12/120
20	PLS6-D20	242705	12/120
25	PLS6-D25	242706	12/120
32	PLS6-D32	242707	12/120
40	PLS6-D40	242708	12/120

SG40111



1+N-pole 1.5MU

6	PLS6-D6/1N	242761	8/80
10	PLS6-D10/1N	242763	8/80
13	PLS6-D13/1N	242765	8/80
16	PLS6-D16/1N	242767	8/80
20	PLS6-D20/1N	242768	8/80
25	PLS6-D25/1N	242769	8/80

SG58211



Rated current I_n (A)	Type Designation	Article No.	Units per package
1+N-pole 2 MU			
6	PLZ6-D6/1N	242828	1/60
10	PLZ6-D10/1N	242830	1/60
13	PLZ6-D13/1N	242832	1/60
16	PLZ6-D16/1N	242834	1/60
20	PLZ6-D20/1N	242835	1/60
25	PLZ6-D25/1N	242836	1/60
32	PLZ6-D32/1N	242837	1/60
40	PLZ6-D40/1N	242838	1/60

SG77911



Rated current I_n (A)	Type Designation	Article No.	Units per package
2-pole			
6	PLS6-D6/2	242897	1/60
10	PLS6-D10/2	242899	1/60
13	PLS6-D13/2	242901	1/60
16	PLS6-D16/2	242903	1/60
20	PLS6-D20/2	242904	1/60
25	PLS6-D25/2	242905	1/60
32	PLS6-D32/2	242906	1/60
40	PLS6-D40/2	242907	1/60

1.5

Miniature Circuit Breakers (MCBs)

xPole

Miniature Circuit Breakers PLS6, PLZ6 (MW)

SG74311



Rated current I_n (A)	Type Designation	Article No.	Units per package
3-pole			
6	PLS6-D6/3	242966	1/40
10	PLS6-D10/3	242968	1/40
13	PLS6-D13/3	242970	1/40
16	PLS6-D16/3	242972	1/40
20	PLS6-D20/3	242973	1/40
25	PLS6-D25/3	242974	1/40
32	PLS6-D32/3	242975	1/40
40	PLS6-D40/3	242976	1/40

SG73911



Rated current I_n (A)	Type Designation	Article No.	Units per package
3+N-pole			
6	PLS6-D6/3N	243035	1/30
10	PLS6-D10/3N	243037	1/30
13	PLS6-D13/3N	243039	1/30
16	PLS6-D16/3N	243041	1/30
20	PLS6-D20/3N	243042	1/30
25	PLS6-D25/3N	243043	1/30
32	PLS6-D32/3N	243044	1/30
40	PLS6-D40/3N	243045	1/30

SG70011



Rated current I_n (A)	Type Designation	Article No.	Units per package
4-pole			
6	PLS6-D6/4	243104	1/30
10	PLS6-D10/4	243106	1/30
13	PLS6-D13/4	243108	1/30
16	PLS6-D16/4	243110	1/30
20	PLS6-D20/4	243111	1/30
25	PLS6-D25/4	243112	1/30
32	PLS6-D32/4	243113	1/30
40	PLS6-D40/4	243114	1/30

SG38011



Description

- High-quality miniature circuit breakers for residential applications
- Contact position indicator red - green
- Guide for secure terminal connection
- 3-position DIN rail clip, permits removal from existing busbar system
- Comprehensive range of accessories can be mounted subsequently
- Rated currents up to 63 A
- Tripping characteristics B, C
- Rated breaking capacity 4.5 kA according to IEC/EN 60898-1

Rated current I_n (A)	Type Designation	Article No.	Units per package
----------------------------	---------------------	-------------	----------------------

4.5 kA, Characteristic B

SG28411



1-pole

6	PLS4-B6	243150	12/120
10	PLS4-B10	243152	12/120
13	PLS4-B13	243154	12/120
16	PLS4-B16	243156	12/120
20	PLS4-B20	243157	12/120
25	PLS4-B25	243158	12/120
32	PLS4-B32	243159	12/120
40	PLS4-B40	243160	12/120
50	PLS4-B50	243161	12/120
63	PLS4-B63	243162	12/120

SG20711



1+N-pole 2 MU

6	PLZ4-B6/1N	243198	1/60
10	PLZ4-B10/1N	243200	1/60
13	PLZ4-B13/1N	243202	1/60
16	PLZ4-B16/1N	243204	1/60
20	PLZ4-B20/1N	243205	1/60
25	PLZ4-B25/1N	243206	1/60
32	PLZ4-B32/1N	243207	1/60
40	PLZ4-B40/1N	243208	1/60
50	PLZ4-B50/1N	243209	1/60
63	PLZ4-B63/1N	243210	1/60

1.5

Miniature Circuit Breakers (MCBs)

xPole

Miniature Circuit Breakers PLS4, PLZ4 (MW)

SG22911



Rated current I_n (A)	Type Designation	Article No.	Units per package
2-pole			
6	PLS4-B6/2	243246	1/60
10	PLS4-B10/2	243248	1/60
13	PLS4-B13/2	243250	1/60
16	PLS4-B16/2	243252	1/60
20	PLS4-B20/2	243253	1/60
25	PLS4-B25/2	243254	1/60
32	PLS4-B32/2	243255	1/60
40	PLS4-B40/2	243256	1/60
50	PLS4-B50/2	243257	1/60
63	PLS4-B63/2	243258	1/60

SG31411



Rated current I_n (A)	Type Designation	Article No.	Units per package
3-pole			
6	PLS4-B6/3	243294	1/40
10	PLS4-B10/3	243296	1/40
13	PLS4-B13/3	243298	1/40
16	PLS4-B16/3	243300	1/40
20	PLS4-B20/3	243301	1/40
25	PLS4-B25/3	243302	1/40
32	PLS4-B32/3	243303	1/40
40	PLS4-B40/3	243304	1/40
50	PLS4-B50/3	243305	1/40
63	PLS4-B63/3	243306	1/40

SG35211



Rated current I_n (A)	Type Designation	Article No.	Units per package
3+N-pole			
6	PLS4-B6/3N	243342	1/30
10	PLS4-B10/3N	243344	1/30
13	PLS4-B13/3N	243346	1/30
16	PLS4-B16/3N	243348	1/30
20	PLS4-B20/3N	243349	1/30
25	PLS4-B25/3N	243350	1/30
32	PLS4-B32/3N	243351	1/30
40	PLS4-B40/3N	243352	1/30
50	PLS4-B50/3N	243353	1/30
63	PLS4-B63/3N	243354	1/30

SG37111



4-pole			
6	PLS4-B6/4	243390	1/30
10	PLS4-B10/4	243392	1/30
13	PLS4-B13/4	243394	1/30
16	PLS4-B16/4	243396	1/30
20	PLS4-B20/4	243397	1/30
25	PLS4-B25/4	243398	1/30
32	PLS4-B32/4	243399	1/30
40	PLS4-B40/4	243400	1/30
50	PLS4-B50/4	243401	1/30
63	PLS4-B63/4	243402	1/30

1.5

Miniature Circuit Breakers (MCBs)

xPole

Miniature Circuit Breakers PLS4, PLZ4 (MW)

Rated current I_n (A)	Type Designation	Article No.	Units per package
----------------------------	---------------------	-------------	----------------------

4.5 kA, Characteristic C

SG28411



1-pole

6	PLS4-C6	243176	12/120
10	PLS4-C10	243178	12/120
13	PLS4-C13	243180	12/120
16	PLS4-C16	243182	12/120
20	PLS4-C20	243183	12/120
25	PLS4-C25	243184	12/120
32	PLS4-C32	243185	12/120
40	PLS4-C40	243186	12/120
50	PLS4-C50	243187	12/120
63	PLS4-C63	243188	12/120

SG20711



1+N-pole 2 MU

6	PLZ4-C6/1N	243224	1/60
10	PLZ4-C10/1N	243226	1/60
13	PLZ4-C13/1N	243228	1/60
16	PLZ4-C16/1N	243230	1/60
20	PLZ4-C20/1N	243231	1/60
25	PLZ4-C25/1N	243232	1/60
32	PLZ4-C32/1N	243233	1/60
40	PLZ4-C40/1N	243234	1/60
50	PLZ4-C50/1N	243235	1/60
63	PLZ4-C63/1N	243236	1/60

SG22911



Rated current I_n (A)	Type Designation	Article No.	Units per package
2-pole			
6	PLS4-C6/2	243272	1/60
10	PLS4-C10/2	243274	1/60
13	PLS4-C13/2	243276	1/60
16	PLS4-C16/2	243278	1/60
20	PLS4-C20/2	243279	1/60
25	PLS4-C25/2	243280	1/60
32	PLS4-C32/2	243281	1/60
40	PLS4-C40/2	243282	1/60
50	PLS4-C50/2	243283	1/60
63	PLS4-C63/2	243284	1/60

SG31411



Rated current I_n (A)	Type Designation	Article No.	Units per package
3-pole			
6	PLS4-C6/3	243320	1/40
10	PLS4-C10/3	243322	1/40
13	PLS4-C13/3	243324	1/40
16	PLS4-C16/3	243326	1/40
20	PLS4-C20/3	243327	1/40
25	PLS4-C25/3	243328	1/40
32	PLS4-C32/3	243329	1/40
40	PLS4-C40/3	243330	1/40
50	PLS4-C50/3	243331	1/40
63	PLS4-C63/3	243332	1/40

1.5

Miniature Circuit Breakers (MCBs)

xPole

Miniature Circuit Breakers PLS4, PLZ4 (MW)

SG35211



Rated current I_n (A)	Type Designation	Article No.	Units per package
3+N-pole			
6	PLS4-C6/3N	243368	1/30
10	PLS4-C10/3N	243370	1/30
13	PLS4-C13/3N	243372	1/30
16	PLS4-C16/3N	243374	1/30
20	PLS4-C20/3N	243375	1/30
25	PLS4-C25/3N	243376	1/30
32	PLS4-C32/3N	243377	1/30
40	PLS4-C40/3N	243378	1/30
50	PLS4-C50/3N	243379	1/30
63	PLS4-C63/3N	243380	1/30

SG37111



Rated current I_n (A)	Type Designation	Article No.	Units per package
4-pole			
6	PLS4-C6/4	243416	1/30
10	PLS4-C10/4	243418	1/30
13	PLS4-C13/4	243420	1/30
16	PLS4-C16/4	243422	1/30
20	PLS4-C20/4	243423	1/30
25	PLS4-C25/4	243424	1/30
32	PLS4-C32/4	243425	1/30
40	PLS4-C40/4	243426	1/30
50	PLS4-C50/4	243427	1/30
63	PLS4-C63/4	243428	1/30

Specifications | Miniature Circuit Breakers PLS..., PLZ...

Description

- High selectivity between MCB and back-up fuse due to low let-through energy
- Compatible with standard busbar
- Twin-purpose terminal (lift/open-mouthed) above and below
- Busbar positioning optionally above or below
- Meets the requirements of insulation co-ordination, distance between contacts ≥ 4 mm, for secure isolation
- Suitable for applications up to 48 V DC (use PLS6-DC for higher DC voltages)

Accessories:

Auxiliary switch for subsequent installation	ZP-IHK	286052
	ZP-WHK	286053
Tripping signal switch for subsequent installation	ZP-NHK	248437
Remote control and automatic switching device	Z-FW/LP	248296
Shunt trip release	ZP-ASA/..	248438, 248439
Undervoltage release	Z-USA/..	248288-248291
Additional terminal 35 mm ²	BB-UL-TEPA/35	169823
Switching interlock	Z-IS/SPE-1TE	274418
Neutral disconnecter	Z-NTS	248443

Technical Data

		PLS..., PLZ...
Electrical		
Design according to		IEC/EN 60898-1
Current test marks as printed onto the device		
Rated voltage	U_n	AC: 230/400 V DC: 48 V (per pole, max. 2 poles)
Rated frequency		50/60 Hz
Rated breaking capacity according to IEC/EN 60898-1	I_{cn}	
PLSM, PLZM		10 kA
PLS6, PLZ6		6 kA
PLS4, PLZ4		4.5 kA
Characteristic		B, C, D
Back-up fuse		
PLSM, PLZM		max. 125 A gL
PLS6, PLZ6		max. 100 A gL
PLS4, PLZ4		max. 80 A gL
Selectivity class		3
Endurance		
electrical components		$\geq 10,000$ switching operations
mechanical components		$\geq 20,000$ switching operations
Line voltage connection		at will (above/below)
Mechanical		
Frame size		45 mm
Device height		80 mm
Device width		17.5 mm per pole (1MU) 26.3 mm: device 1P+N (1.5MU)
Mounting		quick fastening with 3 lock-in positions on DIN rail IEC/EN 60715
Degree of protection		IP20
Upper and lower terminals		open-mouthed/lift terminals
Terminal protection		finger and hand touch safe, DGUV VS3, EN 50274
Terminal capacity		1-25 mm ²
(1p+N, 1,5TE)		1-25 mm ² / 1-16 mm ² (N)
Terminal torque		2-2.4 Nm
(1p+N, 1,5TE)		2-2.4 Nm / 1.2-1.5 Nm (N)
Busbar thickness		0.8 - 2 mm (except N 0.5MU)
Mounting		independent of position
Operation temperature		-25°C to +75°C
Storage- and transport temperature		-40°C up to +75°C

Connection diagrams

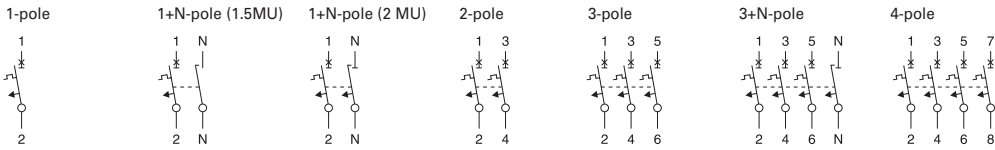

Dimensions (mm)

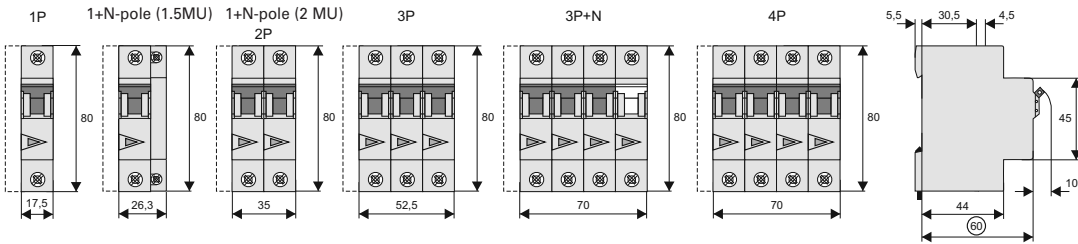

Tripping Characteristics (IEC/EN 60898-1)

Tripping characteristic B

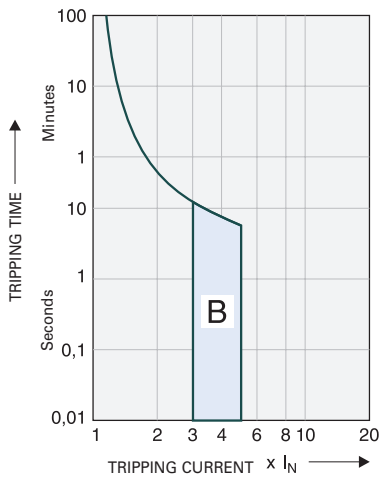

Tripping characteristic C

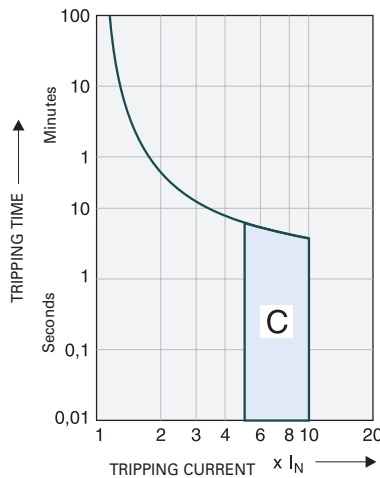

Tripping characteristic D

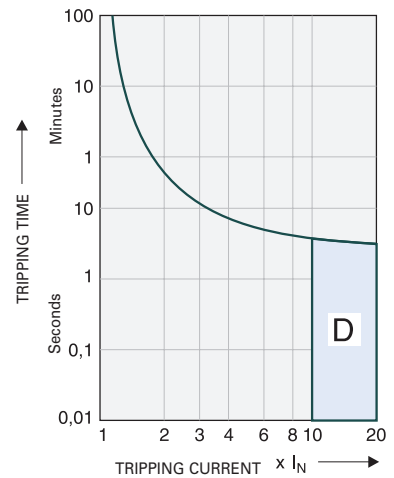

Quick-acting (B), slow (C), very slow (D)

Effect of the Ambient Temperature on Thermal Tripping Behaviour

Adjusted rated current values according to the ambient temperature

I _n [A]	Ambient temperature T [°C]															
	-25	-20	-10	0	10	20	30	35	40	45	50	55	60	65	70	75
0.16	0.20	0.19	0.19	0.18	0.17	0.17	0.16	0.16	0.15	0.15	0.15	0.14	0.14	0.14	0.14	0.13
0.25	0.31	0.30	0.29	0.28	0.27	0.26	0.25	0.25	0.24	0.24	0.23	0.23	0.22	0.22	0.21	0.21
0.5	0.61	0.60	0.58	0.56	0.54	0.52	0.50	0.49	0.48	0.47	0.46	0.45	0.44	0.43	0.42	0.41
0.75	0.92	0.90	0.87	0.84	0.81	0.78	0.75	0.74	0.73	0.71	0.69	0.68	0.66	0.65	0.64	0.62
1	1.2	1.2	1.2	1.1	1.1	1.0	1.0	0.99	0.97	0.95	0.93	0.90	0.89	0.87	0.85	0.83
1.5	1.8	1.8	1.7	1.7	1.6	1.6	1.5	1.5	1.5	1.4	1.4	1.4	1.3	1.3	1.3	1.2
1.6	2.0	1.9	1.9	1.8	1.7	1.7	1.6	1.6	1.5	1.5	1.5	1.4	1.4	1.4	1.4	1.3
2	2.4	2.4	2.3	2.2	2.2	2.1	2.0	2.0	1.9	1.9	1.9	1.8	1.8	1.7	1.7	1.7
2.5	3.1	3.0	2.9	2.8	2.7	2.6	2.5	2.5	2.4	2.4	2.3	2.3	2.2	2.2	2.1	2.1
3	3.7	3.6	3.5	3.4	3.3	3.1	3.0	3.0	2.9	2.8	2.8	2.7	2.7	2.6	2.5	2.5
3.5	4.3	4.2	4.1	3.9	3.8	3.7	3.5	3.4	3.4	3.3	3.2	3.2	3.1	3.0	3.0	2.9
4	4.9	4.8	4.7	4.5	4.3	4.2	4.0	3.9	3.9	3.8	3.7	3.6	3.5	3.5	3.4	3.3
5	6.1	6.0	5.8	5.6	5.4	5.2	5.0	4.9	4.8	4.7	4.6	4.5	4.4	4.3	4.2	4.1
6	7.3	7.2	7.0	6.7	6.5	6.3	6.0	5.9	5.8	5.7	5.6	5.4	5.3	5.2	5.1	5.0
8	9.8	9.6	9.3	9.0	8.7	8.4	8.0	7.9	7.7	7.6	7.4	7.2	7.1	6.9	6.8	6.6
10	12	12	12	11	11	10	10	9.9	9.7	9.5	9.3	9.0	8.9	8.7	8.5	8.3
12	15	14	14	13	13	13	12	12	12	11	11	11	11	10	10	10
13	16	16	15	15	14	14	13	13	13	12	12	12	12	11	11	11
15	18	18	17	17	16	16	15	15	15	14	14	14	13	13	13	12
16	20	19	19	18	17	17	16	16	15	15	15	14	14	14	14	13
20	24	24	23	22	22	21	20	20	19	19	19	18	18	17	17	17
25	31	30	29	28	27	26	25	25	24	24	23	23	22	22	21	21
32	39	38	37	36	35	33	32	32	31	30	30	29	28	28	27	26
40	49	48	47	45	43	42	40	39	39	38	37	36	35	35	34	33
50	61	60	58	56	54	52	50	49	48	47	46	45	44	43	42	41
63	77	76	73	71	68	66	63	62	61	60	58	57	56	55	53	52

Load Capacity of Series Connected Miniature Circuit Breakers

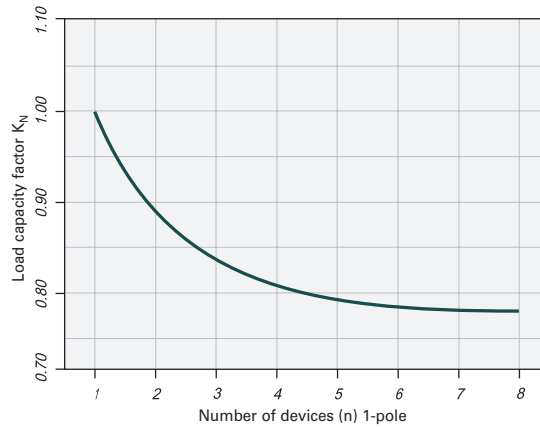

Effect of Power Frequency

Effect of power frequency on the tripping behaviour I_{MA} of the quick release

I _{MA} (f)/I _{MA} (50 Hz) [%]	Power frequency f [Hz]						
	16 ² / ₃	50	60	100	200	300	400
	91	100	101	106	115	134	141

The use of the products in networks with other frequencies than 50/60 Hz is in the customer's responsibility.

Let-through Energy PLSM

Let-through Energy PLSM, Characteristic B, 1-pole

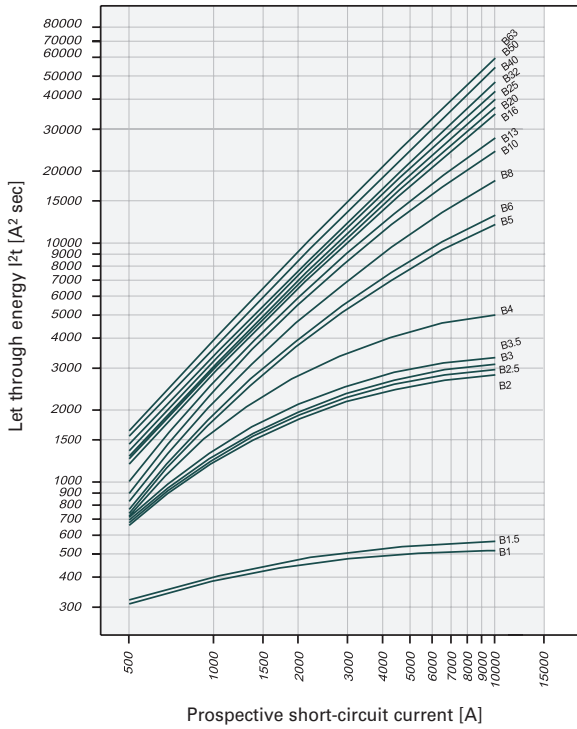

Let-through Energy PLSM, Characteristic C, 1-pole

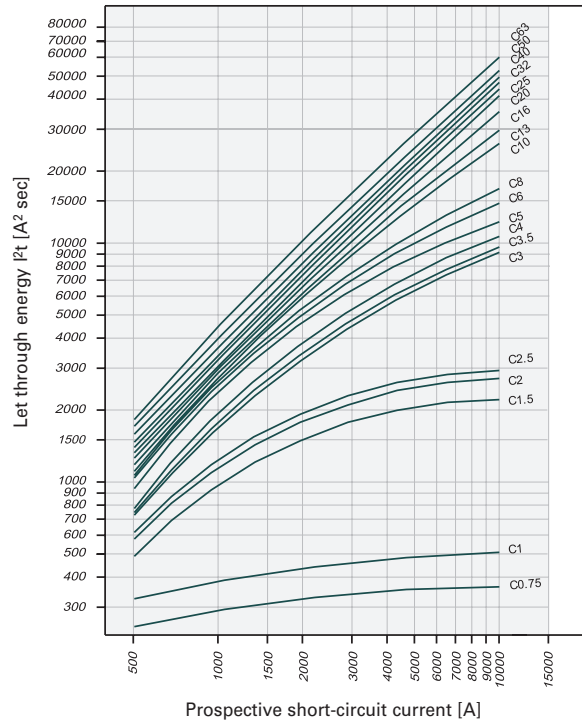

Let-through Energy PLSM, Characteristic D, 1-pole

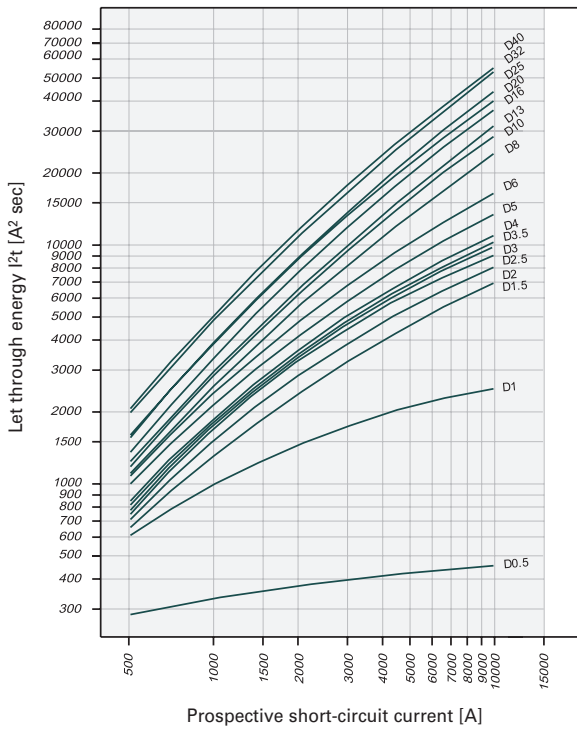

Short-circuit Selectivity PLSM towards DII-DIV fuse link

In case of short-circuit, there is selectivity between the miniature circuit breakers PLSM and the upstream fuses up to the specified values of the selectivity limit current I_s [kA] (i. e. in case of short-circuit currents I_{ks} under I_s only the MCB will trip, in case of short-circuit currents above this value both protective devices will respond).

*) basically in accordance with EN 60898-1 D.5.2.b

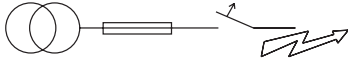

Short-circuit selectivity **Characteristic B** towards fuse link **DII-DIV***)

PLSM I_n [A]	DII-DIV gL/gG								
	10	16	20	25	35	50	63	80	100
1.0	<0.5 ¹⁾	1.2	10.0 ²⁾	10.0 ²⁾	10.0 ²⁾	10.0 ²⁾	10.0 ²⁾	10.0 ²⁾	10.0 ²⁾
1.5	<0.5 ¹⁾	1.0	10.0 ²⁾	10.0 ²⁾	10.0 ²⁾	10.0 ²⁾	10.0 ²⁾	10.0 ²⁾	10.0 ²⁾
2.0	<0.5 ¹⁾	<0.5 ¹⁾	0.8	1.6	10.0 ²⁾	10.0 ²⁾	10.0 ²⁾	10.0 ²⁾	10.0 ²⁾
2.5	<0.5 ¹⁾	<0.5 ¹⁾	0.8	1.5	10.0 ²⁾	10.0 ²⁾	10.0 ²⁾	10.0 ²⁾	10.0 ²⁾
3.0	<0.5 ¹⁾	<0.5 ¹⁾	0.8	1.4	10.0 ²⁾	10.0 ²⁾	10.0 ²⁾	10.0 ²⁾	10.0 ²⁾
3.5	<0.5 ¹⁾	<0.5 ¹⁾	0.7	1.3	10.0 ²⁾	10.0 ²⁾	10.0 ²⁾	10.0 ²⁾	10.0 ²⁾
4	<0.5 ¹⁾	<0.5 ¹⁾	0.6	1.0	3.6	10.0 ²⁾	10.0 ²⁾	10.0 ²⁾	10.0 ²⁾
5	<0.5 ¹⁾	<0.5 ¹⁾	0.6	0.9	2.0	3.5	8.5	10.0 ²⁾	10.0 ²⁾
6		<0.5 ¹⁾	0.6	0.9	1.8	3.2	7.4	10.0 ²⁾	10.0 ²⁾
8		<0.5 ¹⁾	0.5	0.8	1.6	2.6	5.2	8.3	10.0 ²⁾
10			0.5	0.8	1.4	2.2	3.9	6.0	10.0 ²⁾
13			0.5	0.7	1.3	2.0	3.6	5.4	10.0 ²⁾
16				0.6	1.2	1.9	3.2	4.6	8.4
20					1.2	1.8	3.1	4.4	7.8
25					1.2	1.8	3.0	4.2	7.3
32						1.7	2.8	3.9	6.8
40							2.7	3.8	6.5
50							2.5	3.5	5.7
63									5.3

Short-circuit selectivity **Characteristic C** towards fuse link **DII-DIV***)

PLSM I_n [A]	DII-DIV gL/gG								
	10	16	20	25	35	50	63	80	100
0.75	1.0	10.0 ²⁾	10.0 ²⁾	10.0 ²⁾	10.0 ²⁾	10.0 ²⁾	10.0 ²⁾	10.0 ²⁾	10.0 ²⁾
1.0	<0.5 ¹⁾	1.2	10.0 ²⁾	10.0 ²⁾	10.0 ²⁾	10.0 ²⁾	10.0 ²⁾	10.0 ²⁾	10.0 ²⁾
1.5	<0.5 ¹⁾	<0.5 ¹⁾	1.0	2.2	10.0 ²⁾	10.0 ²⁾	10.0 ²⁾	10.0 ²⁾	10.0 ²⁾
2.0	<0.5 ¹⁾	<0.5 ¹⁾	0.8	1.6	10.0 ²⁾	10.0 ²⁾	10.0 ²⁾	10.0 ²⁾	10.0 ²⁾
2.5	<0.5 ¹⁾	<0.5 ¹⁾	0.8	1.4	10.0 ²⁾	10.0 ²⁾	10.0 ²⁾	10.0 ²⁾	10.0 ²⁾
3.0	<0.5 ¹⁾	<0.5 ¹⁾	0.8	0.9	10.0 ²⁾	10.0 ²⁾	10.0 ²⁾	10.0 ²⁾	10.0 ²⁾
3.5	<0.5 ¹⁾	<0.5 ¹⁾	0.6	0.9	2.2	4.5	10.0 ²⁾	10.0 ²⁾	10.0 ²⁾
4	<0.5 ¹⁾	<0.5 ¹⁾	0.6	0.8	1.8	3.6	9.7	10.0 ²⁾	10.0 ²⁾
5	<0.5 ¹⁾	<0.5 ¹⁾	0.6	0.7	1.5	2.7	7.3	10.0 ²⁾	10.0 ²⁾
6		<0.5 ¹⁾	0.5	0.6	1.4	2.4	5.5	10.0 ²⁾	10.0 ²⁾
8		<0.5 ¹⁾	<0.5 ¹⁾	0.6	1.3	2.2	4.7	8.7	10.0 ²⁾
10			<0.5 ¹⁾	0.6	1.3	2.0	3.6	5.4	10.0 ²⁾
13					1.3	1.9	3.3	5.0	9.4
16					1.2	1.8	3.2	4.4	8.0
20					1.2	1.8	3.1	4.1	7.0
25						1.7	2.8	3.8	6.5
32							2.7	3.7	6.2
40								3.5	5.9
50									5.5
63									

Short-circuit selectivity **Characteristic D** towards fuse link **DII-DIV***)

PLSM I_n [A]	DII-DIV gL/gG								
	10	16	20	25	35	50	63	80	100
0.5	0.5	3.0	10.0 ²⁾	10.0 ²⁾	10.0 ²⁾	10.0 ²⁾	10.0 ²⁾	10.0 ²⁾	10.0 ²⁾
1.0	<0.5 ¹⁾	<0.5 ¹⁾	1.0	2.4	10.0 ²⁾	10.0 ²⁾	10.0 ²⁾	10.0 ²⁾	10.0 ²⁾
1.5	<0.5 ¹⁾	<0.5 ¹⁾	0.7	1.2	3.5	7.7	10.0 ²⁾	10.0 ²⁾	10.0 ²⁾
2.0	<0.5 ¹⁾	<0.5 ¹⁾	0.6	1.0	2.8	5.8	10.0 ²⁾	10.0 ²⁾	10.0 ²⁾
2.5	<0.5 ¹⁾	<0.5 ¹⁾	0.6	1.4	2.3	4.6	10.0 ²⁾	10.0 ²⁾	10.0 ²⁾
3.0	<0.5 ¹⁾	<0.5 ¹⁾	0.6	0.9	2.3	4.3	10.0 ²⁾	10.0 ²⁾	10.0 ²⁾
3.5	<0.5 ¹⁾	<0.5 ¹⁾	0.6	0.9	2.1	4.0	10.0 ²⁾	10.0 ²⁾	10.0 ²⁾
4		<0.5 ¹⁾	0.6	0.9	2.0	3.8	9.5	10.0 ²⁾	10.0 ²⁾
5		<0.5 ¹⁾	0.5	0.7	1.7	3.1	7.0	10.0 ²⁾	10.0 ²⁾
6			0.5	0.7	1.5	2.6	5.3	9.1	10.0 ²⁾
8			<0.5 ¹⁾	0.7	1.4	2.2	3.9	6.0	10.0 ²⁾
10				0.7	1.2	1.9	3.4	5.0	9.5
13					1.2	1.8	3.2	4.6	8.6
16						1.6	2.7	4.0	7.4
20						1.5	2.5	3.5	6.7
25							2.4	3.4	6.2
32								2.8	5.0
40									4.8

¹⁾ Selectivity limit current I_s under 0.5 kA

²⁾ Selectivity limit current I_s = rated breaking capacity I_{cn} of the MCB

Darker areas: no selectivity

Short-circuit Selectivity PLSM towards D01-D03 fuse link

In case of short-circuit, there is selectivity between the miniature circuit breakers PLSM and the upstream fuses up to the specified values of the selectivity limit current I_s [kA] (i. e. in case of short-circuit currents I_{ks} under I_s only the MCB will trip, in case of short-circuit currents above this value both protective devices will respond).

*) basically in accordance with EN 60898-1 D.5.2.b

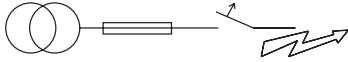

Short-circuit selectivity **Characteristic B** towards fuse link **D01-D03***)

PLSM	D01-D03 gL/gG									
	I_n [A]	10	16	20	25	35	50	63	80	100
1.0	<0.5 ¹⁾	10.0 ²⁾	10.0 ²⁾	10.0 ²⁾	10.0 ²⁾	10.0 ²⁾	10.0 ²⁾	10.0 ²⁾	10.0 ²⁾	10.0 ²⁾
1.5	<0.5 ¹⁾	4.1	10.0 ²⁾	10.0 ²⁾	10.0 ²⁾	10.0 ²⁾	10.0 ²⁾	10.0 ²⁾	10.0 ²⁾	10.0 ²⁾
2.0	<0.5 ¹⁾	<0.5 ¹⁾	0.6	1.0	10.0 ²⁾	10.0 ²⁾	10.0 ²⁾	10.0 ²⁾	10.0 ²⁾	10.0 ²⁾
2.5	<0.5 ¹⁾	<0.5 ¹⁾	0.6	1.0	10.0 ²⁾	10.0 ²⁾	10.0 ²⁾	10.0 ²⁾	10.0 ²⁾	10.0 ²⁾
3.0	<0.5 ¹⁾	<0.5 ¹⁾	0.5	1.0	10.0 ²⁾	10.0 ²⁾	10.0 ²⁾	10.0 ²⁾	10.0 ²⁾	10.0 ²⁾
3.5	<0.5 ¹⁾	<0.5 ¹⁾	0.5	0.9	7.0	10.0 ²⁾	10.0 ²⁾	10.0 ²⁾	10.0 ²⁾	10.0 ²⁾
4	<0.5 ¹⁾	<0.5 ¹⁾	0.5	0.9	2.5	10.0 ²⁾	10.0 ²⁾	10.0 ²⁾	10.0 ²⁾	10.0 ²⁾
5		<0.5 ¹⁾	0.5	0.8	1.7	4.0	7.0	10.0 ²⁾	10.0 ²⁾	10.0 ²⁾
6			<0.5 ¹⁾	0.5	0.8	1.6	3.6	6.0	10.0 ²⁾	10.0 ²⁾
8				0.5	0.8	1.4	2.8	4.3	8.2	10.0 ²⁾
10				0.5	0.7	1.3	2.4	3.4	6.0	10.0 ²⁾
13				<0.5 ¹⁾	0.7	1.2	2.3	3.2	5.3	10.0 ²⁾
16					0.6	1.1	2.2	2.9	4.6	10.0
20						1.1	2.1	2.8	4.4	9.3
25						1.1	2.0	2.7	4.2	8.7
32							2.0	2.6	4.0	8.0
40								2.5	3.8	7.5
50								2.3	3.4	6.7
63										6.2

Short-circuit selectivity **Characteristic C** towards fuse link **D01-D03***)

PLSM	D01-D03 gL/gG									
	I_n [A]	10	16	20	25	35	50	63	80	100
0.75	<0.5 ¹⁾	10.0 ²⁾	10.0 ²⁾	10.0 ²⁾	10.0 ²⁾	10.0 ²⁾	10.0 ²⁾	10.0 ²⁾	10.0 ²⁾	10.0 ²⁾
1.0	<0.5 ¹⁾	10.0 ²⁾	10.0 ²⁾	10.0 ²⁾	10.0 ²⁾	10.0 ²⁾	10.0 ²⁾	10.0 ²⁾	10.0 ²⁾	10.0 ²⁾
1.5	<0.5 ¹⁾	0.5	0.6	0.9	10.0 ²⁾	10.0 ²⁾	10.0 ²⁾	10.0 ²⁾	10.0 ²⁾	10.0 ²⁾
2.0	<0.5 ¹⁾	<0.5 ¹⁾	0.5	0.7	10.0 ²⁾	10.0 ²⁾	10.0 ²⁾	10.0 ²⁾	10.0 ²⁾	10.0 ²⁾
2.5	<0.5 ¹⁾	<0.5 ¹⁾	0.5	0.7	10.0 ²⁾	10.0 ²⁾	10.0 ²⁾	10.0 ²⁾	10.0 ²⁾	10.0 ²⁾
3.0	<0.5 ¹⁾	<0.5 ¹⁾	<0.5 ¹⁾	0.6	1.9	5.2	10.0 ²⁾	10.0 ²⁾	10.0 ²⁾	10.0 ²⁾
3.5	<0.5 ¹⁾	<0.5 ¹⁾	<0.5 ¹⁾	0.6	1.8	4.7	9.5	10.0 ²⁾	10.0 ²⁾	10.0 ²⁾
4	<0.5 ¹⁾	<0.5 ¹⁾	<0.5 ¹⁾	0.6	1.6	4.0	7.6	10.0 ²⁾	10.0 ²⁾	10.0 ²⁾
5		<0.5 ¹⁾	<0.5 ¹⁾	0.5	1.3	3.1	5.7	10.0 ²⁾	10.0 ²⁾	10.0 ²⁾
6		<0.5 ¹⁾	<0.5 ¹⁾	<0.5 ¹⁾	1.2	2.7	4.5	10.0 ²⁾	10.0 ²⁾	10.0 ²⁾
8		<0.5 ¹⁾	<0.5 ¹⁾	<0.5 ¹⁾	1.2	2.5	4.0	8.6	10.0 ²⁾	10.0 ²⁾
10			<0.5 ¹⁾	<0.5 ¹⁾	1.2	2.3	3.1	5.4	10.0 ²⁾	10.0 ²⁾
13					1.1	2.2	3.0	4.9	10.0 ²⁾	10.0 ²⁾
16						1.1	2.1	2.8	4.4	9.5
20						1.0	2.0	2.6	4.0	8.3
25							1.9	2.5	3.8	7.8
32								2.5	3.7	7.3
40									3.5	7.0
50										6.5
63										6.5

Short-circuit selectivity **Characteristic D** towards fuse link **D01-D03***)

PLSM	D01-D03 gL/gG									
	I_n [A]	10	16	20	25	35	50	63	80	100
0.5	<0.5 ¹⁾	10.0 ²⁾	10.0 ²⁾	10.0 ²⁾	10.0 ²⁾	10.0 ²⁾	10.0 ²⁾	10.0 ²⁾	10.0 ²⁾	10.0 ²⁾
1.0	<0.5 ¹⁾	<0.5 ¹⁾	0.7	1.3	10.0 ²⁾	10.0 ²⁾	10.0 ²⁾	10.0 ²⁾	10.0 ²⁾	10.0 ²⁾
1.5	<0.5 ¹⁾	<0.5 ¹⁾	0.6	0.9	2.8	9.0	10.0 ²⁾	10.0 ²⁾	10.0 ²⁾	10.0 ²⁾
2.0	<0.5 ¹⁾	<0.5 ¹⁾	0.6	0.8	2.2	6.7	10.0 ²⁾	10.0 ²⁾	10.0 ²⁾	10.0 ²⁾
2.5	<0.5 ¹⁾	<0.5 ¹⁾	0.5	0.7	1.9	5.4	10.0 ²⁾	10.0 ²⁾	10.0 ²⁾	10.0 ²⁾
3.0	<0.5 ¹⁾	<0.5 ¹⁾	0.5	0.7	1.8	4.8	9.3	10.0 ²⁾	10.0 ²⁾	10.0 ²⁾
3.5	<0.5 ¹⁾	<0.5 ¹⁾	0.5	0.7	1.7	4.7	8.6	10.0 ²⁾	10.0 ²⁾	10.0 ²⁾
4		<0.5 ¹⁾	0.5	0.7	1.7	4.6	7.7	10.0 ²⁾	10.0 ²⁾	10.0 ²⁾
5		<0.5 ¹⁾	<0.5 ¹⁾	0.6	1.5	3.5	5.8	10.0 ²⁾	10.0 ²⁾	10.0 ²⁾
6			<0.5 ¹⁾	0.5	1.3	2.9	4.5	9.0	10.0 ²⁾	10.0 ²⁾
8			<0.5 ¹⁾	0.5	1.2	2.4	3.5	6.0	10.0 ²⁾	10.0 ²⁾
10				0.5	1.1	2.2	3.0	5.0	10.0 ²⁾	10.0 ²⁾
13					1.1	2.1	2.9	4.6	10.0 ²⁾	10.0 ²⁾
16						1.9	2.6	3.9	9.0	10.0 ²⁾
20						1.7	2.3	3.5	8.0	10.0 ²⁾
25							2.2	3.4	7.5	10.0 ²⁾
32								2.9	6.0	10.0 ²⁾
40									5.7	10.0 ²⁾

¹⁾ Selectivity limit current I_s under 0.5 kA

²⁾ Selectivity limit current I_s = rated breaking capacity I_{cn} of the MCB

Darker areas: no selectivity

Short-circuit Selectivity PLSM towards NH-00 fuse link

In case of short-circuit, there is selectivity between the miniature circuit breakers PLSM and the upstream fuses up to the specified values of the selectivity limit current I_s [kA] (i. e. in case of short-circuit currents I_{ks} under I_s only the MCB will trip, in case of short-circuit currents above this value both protective devices will respond).

*) basically in accordance with EN 60898-1 D.5.2.b

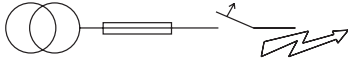

Short-circuit selectivity **Characteristic B** towards fuse link **NH-00***

PLSM I_n [A]	NH-00 gL/gG													
	16	20	25	32	35	40	50	63	80	100	125	160		
1.0	0.9	10.0 ²⁾	10.0 ²⁾	10.0 ²⁾	10.0 ²⁾	10.0 ²⁾	10.0 ²⁾	10.0 ²⁾	10.0 ²⁾	10.0 ²⁾	10.0 ²⁾	10.0 ²⁾	10.0 ²⁾	
1.5	0.8	10.0 ²⁾	10.0 ²⁾	10.0 ²⁾	10.0 ²⁾	10.0 ²⁾	10.0 ²⁾	10.0 ²⁾	10.0 ²⁾	10.0 ²⁾	10.0 ²⁾	10.0 ²⁾	10.0 ²⁾	
2.0	<0.5 ¹⁾	0.5	1.0	2.5	10.0 ²⁾	10.0 ²⁾	10.0 ²⁾	10.0 ²⁾	10.0 ²⁾	10.0 ²⁾	10.0 ²⁾	10.0 ²⁾	10.0 ²⁾	
2.5	<0.5 ¹⁾	0.5	1.0	2.3	10.0 ²⁾	10.0 ²⁾	10.0 ²⁾	10.0 ²⁾	10.0 ²⁾	10.0 ²⁾	10.0 ²⁾	10.0 ²⁾	10.0 ²⁾	
3.0	<0.5 ¹⁾	0.5	0.9	2.1	8.0	10.0 ²⁾	10.0 ²⁾	10.0 ²⁾	10.0 ²⁾	10.0 ²⁾	10.0 ²⁾	10.0 ²⁾	10.0 ²⁾	
3.5	<0.5 ¹⁾	0.5	0.9	1.8	5.5	10.0 ²⁾	10.0 ²⁾	10.0 ²⁾	10.0 ²⁾	10.0 ²⁾	10.0 ²⁾	10.0 ²⁾	10.0 ²⁾	
4	<0.5 ¹⁾	<0.5 ¹⁾	0.8	1.3	2.3	4.3	10.0 ²⁾	10.0 ²⁾	10.0 ²⁾	10.0 ²⁾	10.0 ²⁾	10.0 ²⁾	10.0 ²⁾	
5	<0.5 ¹⁾	<0.5 ¹⁾	0.7	1.1	1.6	2.2	3.6	4.8	8.9	10.0 ²⁾	10.0 ²⁾	10.0 ²⁾	10.0 ²⁾	
6	<0.5 ¹⁾	<0.5 ¹⁾	0.7	1.1	1.5	2.0	3.3	4.3	7.6	10.0 ²⁾	10.0 ²⁾	10.0 ²⁾	10.0 ²⁾	
8	<0.5 ¹⁾	<0.5 ¹⁾	0.6	1.0	1.3	1.7	2.6	3.3	5.2	10.0 ²⁾	10.0 ²⁾	10.0 ²⁾	10.0 ²⁾	
10		<0.5 ¹⁾	0.6	0.9	1.2	1.5	2.2	2.7	4.0	9.0	10.0 ²⁾	10.0 ²⁾	10.0 ²⁾	
13		<0.5 ¹⁾	0.6	0.8	1.1	1.4	2.1	2.6	3.8	7.9	10.0 ²⁾	10.0 ²⁾	10.0 ²⁾	
16			0.5	0.7	1.0	1.3	1.9	2.4	3.4	6.4	9.3	10.0 ²⁾	10.0 ²⁾	
20				0.7	1.0	1.3	1.9	2.4	3.3	6.0	8.7	10.0 ²⁾	10.0 ²⁾	
25					0.7	1.0	1.3	1.8	2.3	5.7	8.0	10.0 ²⁾	10.0 ²⁾	
32						0.9	1.2	1.7	2.2	3.1	5.4	7.6	10.0 ²⁾	
40									2.1	3.0	5.1	7.2	10.0 ²⁾	
50										1.9	2.8	4.7	6.6	9.5
63											4.4	6.3	8.6	10.0 ²⁾

Short-circuit selectivity **Characteristic C** towards fuse link **NH-00***

PLSM I_n [A]	NH-00 gL/gG															
	16	20	25	32	35	40	50	63	80	100	125	160				
0.75	10.0 ²⁾	10.0 ²⁾	10.0 ²⁾	10.0 ²⁾	10.0 ²⁾	10.0 ²⁾	10.0 ²⁾	10.0 ²⁾	10.0 ²⁾	10.0 ²⁾	10.0 ²⁾	10.0 ²⁾	10.0 ²⁾			
1.0	0.9	10.0 ²⁾	10.0 ²⁾	10.0 ²⁾	10.0 ²⁾	10.0 ²⁾	10.0 ²⁾	10.0 ²⁾	10.0 ²⁾	10.0 ²⁾	10.0 ²⁾	10.0 ²⁾	10.0 ²⁾			
1.5	<0.5 ¹⁾	0.6	1.3	4.2	10.0 ²⁾	10.0 ²⁾	10.0 ²⁾	10.0 ²⁾	10.0 ²⁾	10.0 ²⁾	10.0 ²⁾	10.0 ²⁾	10.0 ²⁾			
2.0	<0.5 ¹⁾	0.6	1.0	2.5	10.0 ²⁾	10.0 ²⁾	10.0 ²⁾	10.0 ²⁾	10.0 ²⁾	10.0 ²⁾	10.0 ²⁾	10.0 ²⁾	10.0 ²⁾			
2.5	<0.5 ¹⁾	0.5	1.0	2.1	10.0 ²⁾	10.0 ²⁾	10.0 ²⁾	10.0 ²⁾	10.0 ²⁾	10.0 ²⁾	10.0 ²⁾	10.0 ²⁾	10.0 ²⁾			
3.0	<0.5 ¹⁾	<0.5 ¹⁾	0.7	1.2	1.8	2.6	4.7	6.6	10.0 ²⁾	10.0 ²⁾	10.0 ²⁾	10.0 ²⁾	10.0 ²⁾			
3.5	<0.5 ¹⁾	<0.5 ¹⁾	0.7	1.1	1.7	2.4	4.2	6.0	10.0 ²⁾	10.0 ²⁾	10.0 ²⁾	10.0 ²⁾	10.0 ²⁾			
4	<0.5 ¹⁾	<0.5 ¹⁾	0.7	1.0	1.5	2.1	3.6	5.0	10.0	10.0 ²⁾	10.0 ²⁾	10.0 ²⁾	10.0 ²⁾			
5	<0.5 ¹⁾	<0.5 ¹⁾	0.6	0.8	1.2	1.7	2.8	3.8	8.7	10.0 ²⁾	10.0 ²⁾	10.0 ²⁾	10.0 ²⁾			
6	<0.5 ¹⁾	<0.5 ¹⁾	0.5	0.8	1.2	1.5	2.5	3.3	5.7	10.0 ²⁾	10.0 ²⁾	10.0 ²⁾	10.0 ²⁾			
8	<0.5 ¹⁾	<0.5 ¹⁾	0.5	0.8	1.1	1.5	2.3	2.9	4.9	10.0 ²⁾	10.0 ²⁾	10.0 ²⁾	10.0 ²⁾			
10						0.5	0.7	1.0	1.4	2.0	2.5	3.8	8.0	10.0 ²⁾		
13								1.0	1.3	1.9	2.4	3.6	7.0	10.0 ²⁾		
16									1.0	1.3	1.8	2.3	3.3	6.0	8.8	
20										1.0	1.2	1.7	2.2	3.2	5.5	7.7
25											1.6	2.1	3.0	5.2	7.3	10.0 ²⁾
32												2.1	2.9	5.0	7.0	10.0 ²⁾
40													2.8	4.8	6.7	10.0
50														4.5	6.3	9.5
63															5.9	8.4

Short-circuit selectivity **Characteristic D** towards fuse link **NH-00***

PLSM I_n [A]	NH-00 gL/gG												
	16	20	25	32	35	40	50	63	80	100	125	160	
0.5	2.1	10.0 ²⁾	10.0 ²⁾	10.0 ²⁾	10.0 ²⁾	10.0 ²⁾	10.0 ²⁾	10.0 ²⁾	10.0 ²⁾	10.0 ²⁾	10.0 ²⁾	10.0 ²⁾	10.0 ²⁾
1.0	<0.5 ¹⁾	0.6	1.4	4.3	10.0 ²⁾	10.0 ²⁾	10.0 ²⁾	10.0 ²⁾	10.0 ²⁾	10.0 ²⁾	10.0 ²⁾	10.0 ²⁾	10.0 ²⁾
1.5	<0.5 ¹⁾	<0.5 ¹⁾	0.9	1.6	2.7	4.0	8.0	10.0 ²⁾	10.0 ²⁾	10.0 ²⁾	10.0 ²⁾	10.0 ²⁾	10.0 ²⁾
2.0	<0.5 ¹⁾	<0.5 ¹⁾	0.8	1.3	2.1	3.1	6.0	8.6	10.0 ²⁾	10.0 ²⁾	10.0 ²⁾	10.0 ²⁾	10.0 ²⁾
2.5	<0.5 ¹⁾	<0.5 ¹⁾	0.7	1.2	1.8	2.6	4.8	6.9	10.0 ²⁾	10.0 ²⁾	10.0 ²⁾	10.0 ²⁾	10.0 ²⁾
3.0	<0.5 ¹⁾	<0.5 ¹⁾	0.7	1.1	1.7	2.4	4.3	6.0	10.0 ²⁾	10.0 ²⁾	10.0 ²⁾	10.0 ²⁾	10.0 ²⁾
3.5	<0.5 ¹⁾	<0.5 ¹⁾	0.7	1.1	1.7	2.4	4.2	5.6	10.0 ²⁾	10.0 ²⁾	10.0 ²⁾	10.0 ²⁾	10.0 ²⁾
4	<0.5 ¹⁾	<0.5 ¹⁾	0.7	1.0	1.6	2.2	3.8	5.2	10.0	10.0 ²⁾	10.0 ²⁾	10.0 ²⁾	10.0 ²⁾
5		<0.5 ¹⁾	0.6	0.9	1.4	1.9	3.2	4.1	7.1	10.0 ²⁾	10.0 ²⁾	10.0 ²⁾	10.0 ²⁾
6		<0.5 ¹⁾	0.5	0.8	1.2	1.6	2.6	3.3	5.5	10.0 ²⁾	10.0 ²⁾	10.0 ²⁾	10.0 ²⁾
8			0.5	0.8	1.1	1.5	2.2	2.7	4.1	8.7	10.0 ²⁾	10.0 ²⁾	10.0 ²⁾
10				0.5	0.7	1.0	1.3	1.9	2.5	3.6	7.2	10.0 ²⁾	10.0 ²⁾
13					1.0	1.3	1.9	2.3	3.4	6.5	9.5	10.0 ²⁾	10.0 ²⁾
16						1.1	1.6	2.0	3.0	5.5	8.0	10.0 ²⁾	10.0 ²⁾
20							1.4	1.8	2.8	5.0	7.5	10.0 ²⁾	10.0 ²⁾
25								1.8	2.7	4.8	7.0	10.0 ²⁾	10.0 ²⁾
32									2.4	4.1	6.2	9.3	10.0 ²⁾
40										4.0	6.0	9.0	10.0 ²⁾

¹⁾ Selectivity limit current I_s under 0.5 kA

²⁾ Selectivity limit current I_s = rated breaking capacity I_{cn} of the MCB

Darker areas: no selectivity

Short-circuit Selectivity PLSM towards cylindrical fuse links

In case of short-circuit, there is selectivity between the miniature circuit breakers PLSM and the upstream fuses up to the specified values of the selectivity limit current I_s [kA] (i. e. in case of short-circuit currents I_{ks} under I_s only the MCB will trip, in case of short-circuit currents above this value both protective devices will respond).

*) basically in accordance with EN 60898-1 D.5.2.b



Short-circuit selectivity **Characteristic B** towards fuse link **CH10x38 gG, CH14x51 gG, CH22x58 gG*)**

PLSM I_n [A]	CH10x38 gG				CH15x51 gG					CH22x58 gG								
	16	20	25	32	20	25	32	40	50	16	20	25	32	40	50	63	80	100
1	0.5	>10	>10	>10	>10	>10	>10	>10	>10	1.2	>10	>10	>10	>10	>10	>10	>10	>10
2	<0.5	0.6	1.2	3.6	0.5	1.0	5.2	>10	>10	<0.5	0.5	1.1	>10	>10	>10	>10	>10	>10
3	<0.5	0.5	0.8	1.4	0.5	0.9	3.7	>10	>10	<0.5	0.5	1.0	8.0	>10	>10	>10	>10	>10
4	<0.5	<0.5	0.7	1.2	<0.5	0.7	1.7	4.0	>10	<0.5	<0.5	0.8	2.3	5.1	>10	>10	>10	>10
6	<0.5	<0.5	0.6	0.9	<0.5	0.7	1.3	2.0	2.7	<0.5	<0.5	0.7	1.5	2.2	2.6	5.6	10	>10
10	<0.5	<0.5	0.6	0.9	<0.5	0.6	1.1	1.5	2.0	<0.5	<0.5	0.6	1.2	1.6	1.9	3.2	4.8	9.0
13	<0.5	<0.5	0.6	0.8	<0.5	0.6	1.0	1.4	1.9	<0.5	<0.5	0.6	1.2	1.5	1.7	3.0	4.3	7.7
16		<0.5	0.5	0.8	<0.5	0.5	1.0	1.4	1.8		<0.5	0.5	1.1	1.4	1.6	2.7	3.8	6.3
20			0.5	0.8		<0.5	0.9	1.3	1.6			0.5	1.1	1.4	1.6	2.6	3.7	6.0
25				0.7			0.9	1.3	1.6				1.0	1.3	1.5	2.5	3.5	5.6
32								1.2	1.5					1.3	1.5	2.4	3.3	5.2
40									1.5						1.4	2.3	3.2	5.0
50																2.1	2.9	4.5
63																	2.8	4.2

Short-circuit selectivity **Characteristic C** towards fuse link **CH10x38 gG, CH14x51 gG, CH22x58 gG*)**

PLSM I_n [A]	CH10x38 gG				CH15x51 gG					CH22x58 gG								
	16	20	25	32	20	25	32	40	50	16	20	25	32	40	50	63	80	100
0.5	1.9	>10	>10	>10	>10	>10	>10	>10	>10	>10	>10	>10	>10	>10	>10	>10	>10	>10
1	<0.5	>10	>10	>10	>10	>10	>10	>10	>10	>10	>10	>10	>10	>10	>10	>10	>10	>10
2	<0.5	0.6	1.2	3.6	0.5	1.0	4.5	>10	>10	<0.5	0.6	1.1	>10	>10	>10	>10	>10	>10
3	<0.5	0.5	0.8	1.4	<0.5	0.7	1.4	2.4	3.7	<0.5	<0.5	0.8	1.8	2.7	3.5	9.3	>10	>10
4	<0.5	<0.5	0.7	1.2	<0.5	0.7	1.2	2.0	2.9	<0.5	<0.5	0.7	1.5	2.2	2.7	6.7	>10	>10
6	<0.5	<0.5	0.6	0.9	<0.5	<0.5	1.0	1.4	2.0	<0.5	<0.5	0.6	1.1	1.6	1.9	4.2	7.0	>10
10	<0.5	<0.5	0.5	0.8	<0.5	<0.5	0.9	1.3	1.7	<0.5	<0.5	0.6	1.1	1.5	1.8	2.9	4.1	7.5
13	<0.5	<0.5	0.5	0.8	<0.5	<0.5	0.9	1.3	1.7	<0.5	<0.5	0.5	1.0	1.4	1.7	2.7	3.8	6.5
16		<0.5	0.5	0.8	<0.5	<0.5	0.8	1.2	1.6		<0.5	<0.5	1.0	1.3	1.5	2.6	3.5	5.8
20			<0.5	0.7		<0.5	0.8	1.2	1.5			<0.5	0.9	1.2	1.4	2.5	3.3	5.4
25				0.7			0.8	1.1	1.4				0.9	1.2	1.4	2.3	3.2	5.0
32								1.1	1.4					1.1	1.3	2.2	3.0	4.8
40									1.3					1.2	2.0	2.8	4.6	
50																1.9	2.6	4.2
63																	2.3	3.7

Short-circuit selectivity **Characteristic C** towards fuse link **CH10x38 gG, CH14x51 gG, CH22x58 gG*)**

PLSM I_n [A]	CH10x38 gG				CH15x51 gG					CH22x58 gG								
	16	20	25	32	20	25	32	40	50	16	20	25	32	40	50	63	80	100
0.5	0.9	>10	>10	>10	>10	>10	>10	>10	>10	>10	>10	>10	>10	>10	>10	>10	>10	>10
1	<0.5	>10	>10	>10	>10	>10	>10	>10	>10	<0.5	0.6	1.5	>10	>10	>10	>10	>10	>10
2	<0.5	0.5	0.6	1.6	<0.5	1.0	1.7	>10	>10	<0.5	0.5	0.8	2.1	3.3	4.3	>10	>10	>10
3	<0.5	<0.5	0.8	1.3	<0.5	0.7	1.4	2.4	3.4	<0.5	<0.5	0.7	1.7	2.5	3.2	8.2	>10	>10
4	<0.5	<0.5	0.7	1.2	<0.5	0.7	1.3	2.0	3.1	<0.5	<0.5	0.7	1.6	2.3	3.0	7.0	>10	>10
6	<0.5	<0.5	0.6	1.0	<0.5	<0.5	1.0	1.6	2.0	<0.5	<0.5	0.6	1.3	1.7	2.1	4.2	7.0	>10
10	<0.5	<0.5	0.6	0.8	<0.5	<0.5	0.9	1.3	1.7	<0.5	<0.5	0.5	1.1	1.4	1.6	2.8	4.1	7.1
13	<0.5	<0.5	0.5	0.8	<0.5	<0.5	0.9	1.3	1.6	<0.5	<0.5	0.5	1.0	1.4	1.6	2.7	3.8	6.5
16		<0.5	0.5	0.7	<0.5	<0.5	0.8	1.1	1.4		<0.5	<0.5	1.0	1.2	1.4	2.3	3.2	5.5
20			<0.5	0.7		<0.5	0.7	1.0	1.3			<0.5	0.8	1.1	1.3	2.1	2.9	4.6
25				0.7			0.7	1.0	1.2				0.8	1.0	1.2	2.0	2.8	4.0
32														0.9	1.0	1.7	2.3	3.8
40															1.0	2.0	2.2	3.6

Darker areas: no selectivity

Let-through Energy PLS6

Let-through Energy PLS6, Characteristic B, 1-pole

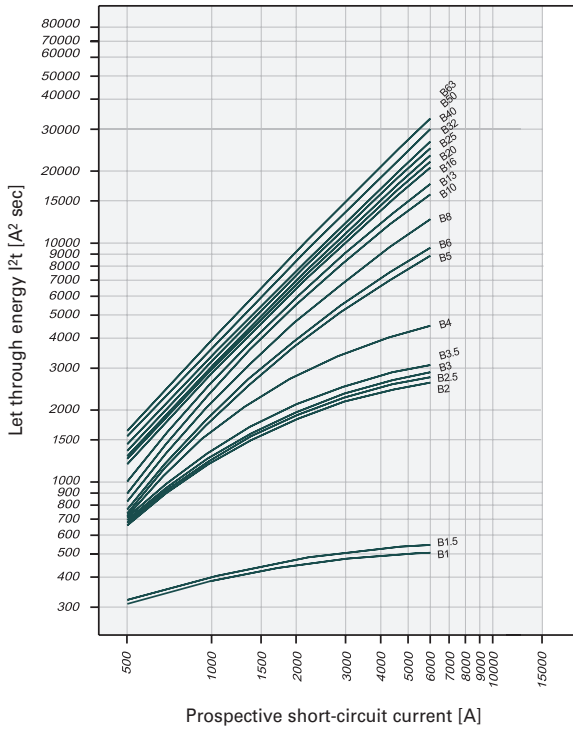

Let-through Energy PLS6, Characteristic C, 1-pole

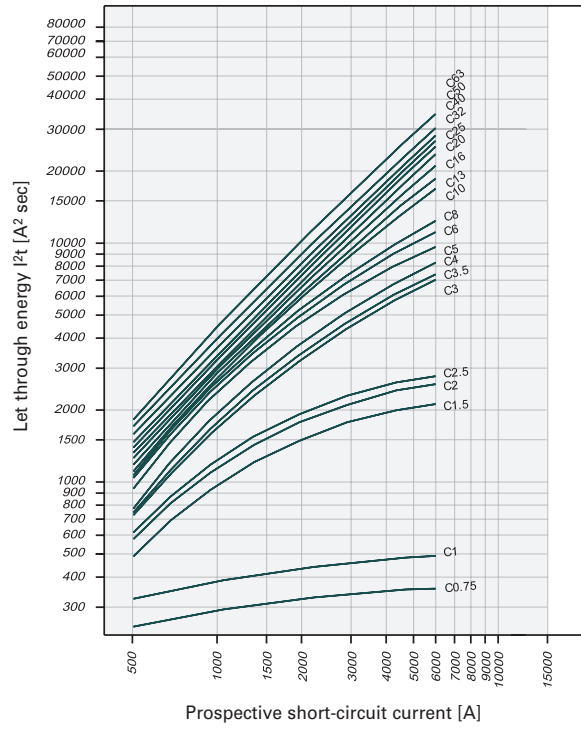

Let-through Energy PLS6, Characteristic D, 1-pole

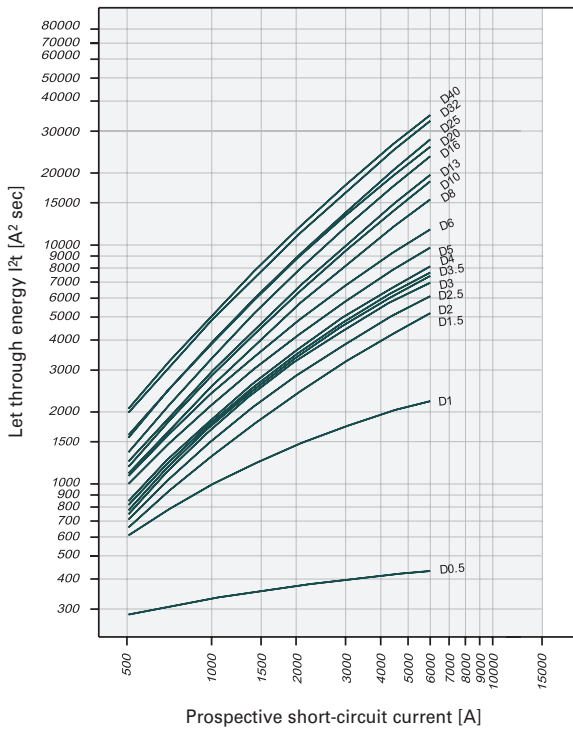

Short-circuit Selectivity PLS6 towards DII-DIV fuse link

In case of short-circuit, there is selectivity between the miniature circuit breakers PLS6 and the upstream fuses up to the specified values of the selectivity limit current I_s [kA] (i. e. in case of short-circuit currents I_{ks} under I_s only the MCB will trip, in case of short-circuit currents above this value both protective devices will respond).

*) basically in accordance with EN 60898-1 D.5.2.b

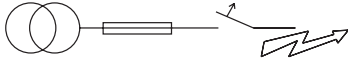

Short-circuit selectivity **Characteristic B** towards fuse link **DII-DIV***)

PLS6 I_n [A]	DII-DIV gL/gG								
	10	16	20	25	35	50	63	80	100
1.0	<0.5 ¹⁾	1.2	6.0 ²⁾	6.0 ²⁾	6.0 ²⁾	6.0 ²⁾	6.0 ²⁾	6.0 ²⁾	6.0 ²⁾
1.5	<0.5 ¹⁾	1.0	6.0 ²⁾	6.0 ²⁾	6.0 ²⁾	6.0 ²⁾	6.0 ²⁾	6.0 ²⁾	6.0 ²⁾
2.0	<0.5 ¹⁾	<0.5 ¹⁾	0.8	1.6	6.0 ²⁾	6.0 ²⁾	6.0 ²⁾	6.0 ²⁾	6.0 ²⁾
2.5	<0.5 ¹⁾	<0.5 ¹⁾	0.8	1.5	6.0 ²⁾	6.0 ²⁾	6.0 ²⁾	6.0 ²⁾	6.0 ²⁾
3.0	<0.5 ¹⁾	<0.5 ¹⁾	0.8	1.4	6.0 ²⁾	6.0 ²⁾	6.0 ²⁾	6.0 ²⁾	6.0 ²⁾
3.5	<0.5 ¹⁾	<0.5 ¹⁾	0.7	1.3	6.0 ²⁾	6.0 ²⁾	6.0 ²⁾	6.0 ²⁾	6.0 ²⁾
4	<0.5 ¹⁾	<0.5 ¹⁾	0.6	1.0	3.6	6.0 ²⁾	6.0 ²⁾	6.0 ²⁾	6.0 ²⁾
5	<0.5 ¹⁾	<0.5 ¹⁾	0.6	0.9	2.0	3.5	6.0 ²⁾	6.0 ²⁾	6.0 ²⁾
6		<0.5 ¹⁾	0.6	0.9	1.8	3.2	6.0 ²⁾	6.0 ²⁾	6.0 ²⁾
8		<0.5 ¹⁾	0.5	0.8	1.6	2.6	5.2	6.0 ²⁾	6.0 ²⁾
10			0.5	0.8	1.4	2.2	3.9	6.0 ²⁾	6.0 ²⁾
13			0.5	0.7	1.3	2.0	3.6	5.4	6.0 ²⁾
16				0.6	1.2	1.9	3.2	4.6	6.0 ²⁾
20					1.2	1.8	3.1	4.4	6.0 ²⁾
25					1.2	1.8	3.0	4.2	6.0 ²⁾
32						1.7	2.8	3.9	6.0 ²⁾
40							2.7	3.8	6.0 ²⁾
50							2.5	3.5	5.7
63									5.3

Short-circuit selectivity **Characteristic C** towards fuse link **DII-DIV***)

PLS6 I_n [A]	DII-DIV gL/gG								
	10	16	20	25	35	50	63	80	100
0.75	1.0	6.0 ²⁾	6.0 ²⁾	6.0 ²⁾	6.0 ²⁾	6.0 ²⁾	6.0 ²⁾	6.0 ²⁾	6.0 ²⁾
1.0	<0.5 ¹⁾	1.2	6.0 ²⁾	6.0 ²⁾	6.0 ²⁾	6.0 ²⁾	6.0 ²⁾	6.0 ²⁾	6.0 ²⁾
1.5	<0.5 ¹⁾	<0.5 ¹⁾	1.0	2.2	6.0 ²⁾	6.0 ²⁾	6.0 ²⁾	6.0 ²⁾	6.0 ²⁾
2.0	<0.5 ¹⁾	<0.5 ¹⁾	0.8	1.6	6.0 ²⁾	6.0 ²⁾	6.0 ²⁾	6.0 ²⁾	6.0 ²⁾
2.5	<0.5 ¹⁾	<0.5 ¹⁾	0.8	1.4	6.0 ²⁾	6.0 ²⁾	6.0 ²⁾	6.0 ²⁾	6.0 ²⁾
3.0	<0.5 ¹⁾	<0.5 ¹⁾	0.8	0.9	6.0 ²⁾	6.0 ²⁾	6.0 ²⁾	6.0 ²⁾	6.0 ²⁾
3.5	<0.5 ¹⁾	<0.5 ¹⁾	0.6	0.9	2.2	4.5	6.0 ²⁾	6.0 ²⁾	6.0 ²⁾
4	<0.5 ¹⁾	<0.5 ¹⁾	0.6	0.8	1.8	3.6	6.0 ²⁾	6.0 ²⁾	6.0 ²⁾
5	<0.5 ¹⁾	<0.5 ¹⁾	0.6	0.7	1.5	2.7	6.0 ²⁾	6.0 ²⁾	6.0 ²⁾
6		<0.5 ¹⁾	0.5	0.6	1.4	2.4	5.5	6.0 ²⁾	6.0 ²⁾
8		<0.5 ¹⁾	<0.5 ¹⁾	0.6	1.3	2.2	4.7	6.0 ²⁾	6.0 ²⁾
10			<0.5 ¹⁾	0.6	1.3	2.0	3.6	6.0 ²⁾	6.0 ²⁾
13					1.3	1.9	3.3	5.0	6.0 ²⁾
16					1.2	1.8	3.2	4.4	6.0 ²⁾
20					1.2	1.8	3.1	4.1	6.0 ²⁾
25						1.7	2.8	3.8	6.0 ²⁾
32							2.7	3.7	6.0 ²⁾
40								3.5	5.9
50									5.5
63									

Short-circuit selectivity **Characteristic D** towards fuse link **DII-DIV***)

PLS6 I_n [A]	DII-DIV gL/gG								
	10	16	20	25	35	50	63	80	100
0.5	0.5	3.0	6.0 ²⁾	6.0 ²⁾	6.0 ²⁾	6.0 ²⁾	6.0 ²⁾	6.0 ²⁾	6.0 ²⁾
1.0	<0.5 ¹⁾	<0.5 ¹⁾	1.0	2.4	6.0 ²⁾	6.0 ²⁾	6.0 ²⁾	6.0 ²⁾	6.0 ²⁾
1.5	<0.5 ¹⁾	<0.5 ¹⁾	0.7	1.2	3.5	6.0 ²⁾	6.0 ²⁾	6.0 ²⁾	6.0 ²⁾
2.0	<0.5 ¹⁾	<0.5 ¹⁾	0.6	1.0	2.8	5.8	6.0 ²⁾	6.0 ²⁾	6.0 ²⁾
2.5	<0.5 ¹⁾	<0.5 ¹⁾	0.6	1.4	2.3	4.6	6.0 ²⁾	6.0 ²⁾	6.0 ²⁾
3.0	<0.5 ¹⁾	<0.5 ¹⁾	0.6	0.9	2.3	4.3	6.0 ²⁾	6.0 ²⁾	6.0 ²⁾
3.5	<0.5 ¹⁾	<0.5 ¹⁾	0.6	0.9	2.1	4.0	6.0 ²⁾	6.0 ²⁾	6.0 ²⁾
4		<0.5 ¹⁾	0.6	0.9	2.0	3.8	6.0 ²⁾	6.0 ²⁾	6.0 ²⁾
5		<0.5 ¹⁾	0.5	0.7	1.7	3.1	6.0 ²⁾	6.0 ²⁾	6.0 ²⁾
6			0.5	0.7	1.5	2.6	5.3	6.0 ²⁾	6.0 ²⁾
8			<0.5 ¹⁾	0.7	1.4	2.2	3.9	6.0 ²⁾	6.0 ²⁾
10				0.7	1.2	1.9	3.4	5.0	6.0 ²⁾
13					1.2	1.8	3.2	4.6	6.0 ²⁾
16						1.6	2.7	4.0	6.0 ²⁾
20						1.5	2.5	3.5	6.0 ²⁾
25							2.4	3.4	6.0 ²⁾
32								2.8	5.0
40									4.8

¹⁾ Selectivity limit current I_s under 0.5 kA

²⁾ Selectivity limit current I_s = rated breaking capacity I_{cn} of the MCB

Darker areas: no selectivity

Short-circuit Selectivity PLS6 towards D01-D03 fuse link

In case of short-circuit, there is selectivity between the miniature circuit breakers PLS6 and the upstream fuses up to the specified values of the selectivity limit current I_s [kA] (i. e. in case of short-circuit currents I_{ks} under I_s only the MCB will trip, in case of short-circuit currents above this value both protective devices will respond).

*) basically in accordance with EN 60898-1 D.5.2.b

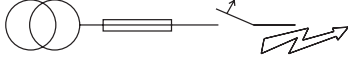

Short-circuit selectivity **Characteristic B** towards fuse link **D01-D03***)

PLS6 I_n [A]	D01-D03 gL/gG								
	10	16	20	25	35	50	63	80	100
1.0	<0.5 ¹⁾	6.0 ²⁾	6.0 ²⁾	6.0 ²⁾	6.0 ²⁾	6.0 ²⁾	6.0 ²⁾	6.0 ²⁾	6.0 ²⁾
1.5	<0.5 ¹⁾	4.1	6.0 ²⁾	6.0 ²⁾	6.0 ²⁾	6.0 ²⁾	6.0 ²⁾	6.0 ²⁾	6.0 ²⁾
2.0	<0.5 ¹⁾	<0.5 ¹⁾	0.6	1.0	6.0 ²⁾	6.0 ²⁾	6.0 ²⁾	6.0 ²⁾	6.0 ²⁾
2.5	<0.5 ¹⁾	<0.5 ¹⁾	0.6	1.0	6.0 ²⁾	6.0 ²⁾	6.0 ²⁾	6.0 ²⁾	6.0 ²⁾
3.0	<0.5 ¹⁾	<0.5 ¹⁾	0.5	1.0	6.0 ²⁾	6.0 ²⁾	6.0 ²⁾	6.0 ²⁾	6.0 ²⁾
3.5	<0.5 ¹⁾	<0.5 ¹⁾	0.5	0.9	6.0 ²⁾	6.0 ²⁾	6.0 ²⁾	6.0 ²⁾	6.0 ²⁾
4	<0.5 ¹⁾	<0.5 ¹⁾	0.5	0.9	2.5	6.0 ²⁾	6.0 ²⁾	6.0 ²⁾	6.0 ²⁾
5		<0.5 ¹⁾	0.5	0.8	1.7	4.0	6.0 ²⁾	6.0 ²⁾	6.0 ²⁾
6		<0.5 ¹⁾	0.5	0.8	1.6	3.6	6.0 ²⁾	6.0 ²⁾	6.0 ²⁾
8			0.5	0.8	1.4	2.8	4.3	6.0 ²⁾	6.0 ²⁾
10			0.5	0.7	1.3	2.4	3.4	6.0 ²⁾	6.0 ²⁾
13			<0.5 ¹⁾	0.7	1.2	2.3	3.2	5.3	6.0 ²⁾
16				0.6	1.1	2.2	2.9	4.6	6.0 ²⁾
20					1.1	2.1	2.8	4.4	6.0 ²⁾
25					1.1	2.0	2.7	4.2	6.0 ²⁾
32						2.0	2.6	4.0	6.0 ²⁾
40							2.5	3.8	6.0 ²⁾
50							2.3	3.4	6.0 ²⁾
63									6.0 ²⁾

Short-circuit selectivity **Characteristic C** towards fuse link **D01-D03***)

PLS6 I_n [A]	D01-D03 gL/gG								
	10	16	20	25	35	50	63	80	100
0.75	<0.5 ¹⁾	6.0 ²⁾	6.0 ²⁾	6.0 ²⁾	6.0 ²⁾	6.0 ²⁾	6.0 ²⁾	6.0 ²⁾	6.0 ²⁾
1.0	<0.5 ¹⁾	6.0 ²⁾	6.0 ²⁾	6.0 ²⁾	6.0 ²⁾	6.0 ²⁾	6.0 ²⁾	6.0 ²⁾	6.0 ²⁾
1.5	<0.5 ¹⁾	0.5	0.6	0.9	6.0 ²⁾	6.0 ²⁾	6.0 ²⁾	6.0 ²⁾	6.0 ²⁾
2.0	<0.5 ¹⁾	<0.5 ¹⁾	0.5	0.7	6.0 ²⁾	6.0 ²⁾	6.0 ²⁾	6.0 ²⁾	6.0 ²⁾
2.5	<0.5 ¹⁾	<0.5 ¹⁾	0.5	0.7	6.0 ²⁾	6.0 ²⁾	6.0 ²⁾	6.0 ²⁾	6.0 ²⁾
3.0	<0.5 ¹⁾	<0.5 ¹⁾	<0.5 ¹⁾	0.6	1.9	5.2	6.0 ²⁾	6.0 ²⁾	6.0 ²⁾
3.5	<0.5 ¹⁾	<0.5 ¹⁾	<0.5 ¹⁾	0.6	1.8	4.7	6.0 ²⁾	6.0 ²⁾	6.0 ²⁾
4	<0.5 ¹⁾	<0.5 ¹⁾	<0.5 ¹⁾	0.6	1.6	4.0	6.0 ²⁾	6.0 ²⁾	6.0 ²⁾
5		<0.5 ¹⁾	<0.5 ¹⁾	0.5	1.3	3.1	5.7	6.0 ²⁾	6.0 ²⁾
6		<0.5 ¹⁾	<0.5 ¹⁾	<0.5 ¹⁾	1.2	2.7	4.5	6.0 ²⁾	6.0 ²⁾
8		<0.5 ¹⁾	<0.5 ¹⁾	<0.5 ¹⁾	1.2	2.5	4.0	6.0 ²⁾	6.0 ²⁾
10			<0.5 ¹⁾	<0.5 ¹⁾	1.2	2.3	3.1	5.4	6.0 ²⁾
13					1.1	2.2	3.0	4.9	6.0 ²⁾
16					1.1	2.1	2.8	4.4	6.0 ²⁾
20					1.0	2.0	2.6	4.0	6.0 ²⁾
25						1.9	2.5	3.8	6.0 ²⁾
32							2.5	3.7	6.0 ²⁾
40								3.5	6.0 ²⁾
50									6.0 ²⁾
63									

Short-circuit selectivity **Characteristic D** towards fuse link **D01-D03***)

PLS6 I_n [A]	D01-D03 gL/gG								
	10	16	20	25	35	50	63	80	100
0.5	<0.5 ¹⁾	6.0 ²⁾	6.0 ²⁾	6.0 ²⁾	6.0 ²⁾	6.0 ²⁾	6.0 ²⁾	6.0 ²⁾	6.0 ²⁾
1.0	<0.5 ¹⁾	<0.5 ¹⁾	0.7	1.3	6.0 ²⁾	6.0 ²⁾	6.0 ²⁾	6.0 ²⁾	6.0 ²⁾
1.5	<0.5 ¹⁾	<0.5 ¹⁾	0.6	0.9	2.8	6.0 ²⁾	6.0 ²⁾	6.0 ²⁾	6.0 ²⁾
2.0	<0.5 ¹⁾	<0.5 ¹⁾	0.6	0.8	2.2	6.0 ²⁾	6.0 ²⁾	6.0 ²⁾	6.0 ²⁾
2.5	<0.5 ¹⁾	<0.5 ¹⁾	0.5	0.7	1.9	5.4	6.0 ²⁾	6.0 ²⁾	6.0 ²⁾
3.0	<0.5 ¹⁾	<0.5 ¹⁾	0.5	0.7	1.8	4.8	6.0 ²⁾	6.0 ²⁾	6.0 ²⁾
3.5	<0.5 ¹⁾	<0.5 ¹⁾	0.5	0.7	1.7	4.7	6.0 ²⁾	6.0 ²⁾	6.0 ²⁾
4		<0.5 ¹⁾	0.5	0.7	1.7	4.6	6.0 ²⁾	6.0 ²⁾	6.0 ²⁾
5		<0.5 ¹⁾	<0.5 ¹⁾	0.6	1.5	3.5	5.8	6.0 ²⁾	6.0 ²⁾
6			<0.5 ¹⁾	0.5	1.3	2.9	4.5	6.0 ²⁾	6.0 ²⁾
8			<0.5 ¹⁾	0.5	1.2	2.4	3.5	6.0 ²⁾	6.0 ²⁾
10				0.5	1.1	2.2	3.0	5.0	6.0 ²⁾
13					1.1	2.1	2.9	4.6	6.0 ²⁾
16						1.9	2.6	3.9	6.0 ²⁾
20						1.7	2.3	3.5	6.0 ²⁾
25							2.2	3.4	6.0 ²⁾
32								2.9	6.0 ²⁾
40									5.7

¹⁾ Selectivity limit current I_s under 0.5 kA

²⁾ Selectivity limit current I_s = rated breaking capacity I_{cn} of the MCB

Darker areas: no selectivity

Short-circuit Selectivity PLS6 towards NH-00 fuse link

In case of short-circuit, there is selectivity between the miniature circuit breakers PLS6 and the upstream fuses up to the specified values of the selectivity limit current I_s [kA] (i. e. in case of short-circuit currents I_{ks} under I_s only the MCB will trip, in case of short-circuit currents above this value both protective devices will respond).

*) basically in accordance with EN 60898-1 D.5.2.b

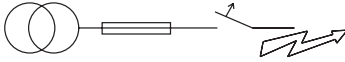

Short-circuit selectivity **Characteristic B** towards fuse link **NH-00***

PLS6 I_n [A]	NH-00 gL/gG												
	16	20	25	32	35	40	50	63	80	100	125	160	
1.0	0.9	6.0 ²⁾	6.0 ²⁾	6.0 ²⁾	6.0 ²⁾	6.0 ²⁾	6.0 ²⁾	6.0 ²⁾	6.0 ²⁾	6.0 ²⁾	6.0 ²⁾	6.0 ²⁾	
1.5	0.8	6.0 ²⁾	6.0 ²⁾	6.0 ²⁾	6.0 ²⁾	6.0 ²⁾	6.0 ²⁾	6.0 ²⁾	6.0 ²⁾	6.0 ²⁾	6.0 ²⁾	6.0 ²⁾	
2.0	<0.5 ¹⁾	0.5	1.0	2.5	6.0 ²⁾	6.0 ²⁾	6.0 ²⁾	6.0 ²⁾	6.0 ²⁾	6.0 ²⁾	6.0 ²⁾	6.0 ²⁾	
2.5	<0.5 ¹⁾	0.5	1.0	2.3	6.0 ²⁾	6.0 ²⁾	6.0 ²⁾	6.0 ²⁾	6.0 ²⁾	6.0 ²⁾	6.0 ²⁾	6.0 ²⁾	
3.0	<0.5 ¹⁾	0.5	0.9	2.1	6.0 ²⁾	6.0 ²⁾	6.0 ²⁾	6.0 ²⁾	6.0 ²⁾	6.0 ²⁾	6.0 ²⁾	6.0 ²⁾	
3.5	<0.5 ¹⁾	0.5	0.9	1.8	5.5	6.0 ²⁾	6.0 ²⁾	6.0 ²⁾	6.0 ²⁾	6.0 ²⁾	6.0 ²⁾	6.0 ²⁾	
4	<0.5 ¹⁾	<0.5 ¹⁾	0.8	1.3	2.3	4.3	6.0 ²⁾	6.0 ²⁾	6.0 ²⁾	6.0 ²⁾	6.0 ²⁾	6.0 ²⁾	
5	<0.5 ¹⁾	<0.5 ¹⁾	0.7	1.1	1.6	2.2	3.6	4.8	6.0 ²⁾	6.0 ²⁾	6.0 ²⁾	6.0 ²⁾	
6	<0.5 ¹⁾	<0.5 ¹⁾	0.7	1.1	1.5	2.0	3.3	4.3	6.0 ²⁾	6.0 ²⁾	6.0 ²⁾	6.0 ²⁾	
8	<0.5 ¹⁾	<0.5 ¹⁾	0.6	1.0	1.3	1.7	2.6	3.3	5.2	6.0 ²⁾	6.0 ²⁾	6.0 ²⁾	
10	<0.5 ¹⁾	0.6	0.9	1.2	1.5	2.2	2.7	4.0	6.0 ²⁾	6.0 ²⁾	6.0 ²⁾	6.0 ²⁾	
13	<0.5 ¹⁾	0.6	0.8	1.1	1.4	2.1	2.6	3.8	6.0 ²⁾	6.0 ²⁾	6.0 ²⁾	6.0 ²⁾	
16		0.5	0.7	1.0	1.3	1.9	2.4	3.4	6.0 ²⁾	6.0 ²⁾	6.0 ²⁾	6.0 ²⁾	
20			0.7	1.0	1.3	1.9	2.4	3.3	6.0 ²⁾	6.0 ²⁾	6.0 ²⁾	6.0 ²⁾	
25				0.7	1.0	1.3	1.8	2.3	3.2	5.7	6.0 ²⁾	6.0 ²⁾	
32					0.9	1.2	1.7	2.2	3.1	5.4	6.0 ²⁾	6.0 ²⁾	
40								2.1	3.0	5.1	6.0 ²⁾	6.0 ²⁾	
50									1.9	2.8	4.7	6.0 ²⁾	6.0 ²⁾
63										4.4	6.0 ²⁾	6.0 ²⁾	

Short-circuit selectivity **Characteristic C** towards fuse link **NH-00***

PLS6 I_n [A]	NH-00 gL/gG												
	16	20	25	32	35	40	50	63	80	100	125	160	
0.75	6.0 ²⁾	6.0 ²⁾	6.0 ²⁾	6.0 ²⁾	6.0 ²⁾	6.0 ²⁾	6.0 ²⁾	6.0 ²⁾	6.0 ²⁾	6.0 ²⁾	6.0 ²⁾	6.0 ²⁾	
1.0	0.9	6.0 ²⁾	6.0 ²⁾	6.0 ²⁾	6.0 ²⁾	6.0 ²⁾	6.0 ²⁾	6.0 ²⁾	6.0 ²⁾	6.0 ²⁾	6.0 ²⁾	6.0 ²⁾	
1.5	<0.5 ¹⁾	0.6	1.3	4.2	6.0 ²⁾	6.0 ²⁾	6.0 ²⁾	6.0 ²⁾	6.0 ²⁾	6.0 ²⁾	6.0 ²⁾	6.0 ²⁾	
2.0	<0.5 ¹⁾	0.6	1.0	2.5	6.0 ²⁾	6.0 ²⁾	6.0 ²⁾	6.0 ²⁾	6.0 ²⁾	6.0 ²⁾	6.0 ²⁾	6.0 ²⁾	
2.5	<0.5 ¹⁾	0.5	1.0	2.1	6.0 ²⁾	6.0 ²⁾	6.0 ²⁾	6.0 ²⁾	6.0 ²⁾	6.0 ²⁾	6.0 ²⁾	6.0 ²⁾	
3.0	<0.5 ¹⁾	<0.5 ¹⁾	0.7	1.2	1.8	2.6	4.7	6.0 ²⁾	6.0 ²⁾	6.0 ²⁾	6.0 ²⁾	6.0 ²⁾	
3.5	<0.5 ¹⁾	<0.5 ¹⁾	0.7	1.1	1.7	2.4	4.2	6.0 ²⁾	6.0 ²⁾	6.0 ²⁾	6.0 ²⁾	6.0 ²⁾	
4	<0.5 ¹⁾	<0.5 ¹⁾	0.7	1.0	1.5	2.1	3.6	5.0	6.0 ²⁾	6.0 ²⁾	6.0 ²⁾	6.0 ²⁾	
5	<0.5 ¹⁾	<0.5 ¹⁾	0.6	0.8	1.2	1.7	2.8	3.8	6.0 ²⁾	6.0 ²⁾	6.0 ²⁾	6.0 ²⁾	
6	<0.5 ¹⁾	<0.5 ¹⁾	0.5	0.8	1.2	1.5	2.5	3.3	5.7	6.0 ²⁾	6.0 ²⁾	6.0 ²⁾	
8	<0.5 ¹⁾	<0.5 ¹⁾	0.5	0.8	1.1	1.5	2.3	2.9	4.9	6.0 ²⁾	6.0 ²⁾	6.0 ²⁾	
10			0.5	0.7	1.0	1.4	2.0	2.5	3.8	6.0 ²⁾	6.0 ²⁾	6.0 ²⁾	
13					1.0	1.3	1.9	2.4	3.6	6.0 ²⁾	6.0 ²⁾	6.0 ²⁾	
16						1.0	1.3	1.8	2.3	3.3	6.0 ²⁾	6.0 ²⁾	
20							1.0	1.2	1.7	2.2	3.2	5.5	6.0 ²⁾
25								1.6	2.1	3.0	5.2	6.0 ²⁾	6.0 ²⁾
32									2.1	2.9	5.0	6.0 ²⁾	6.0 ²⁾
40										2.8	4.8	6.0 ²⁾	6.0 ²⁾
50											4.5	6.0 ²⁾	6.0 ²⁾
63												5.9	6.0 ²⁾

Short-circuit selectivity **Characteristic D** towards fuse link **NH-00***

PLS6 I_n [A]	NH-00 gL/gG												
	16	20	25	32	35	40	50	63	80	100	125	160	
0.5	2.1	6.0 ²⁾	6.0 ²⁾	6.0 ²⁾	6.0 ²⁾	6.0 ²⁾	6.0 ²⁾	6.0 ²⁾	6.0 ²⁾	6.0 ²⁾	6.0 ²⁾	6.0 ²⁾	
1.0	<0.5 ¹⁾	0.6	1.4	4.3	6.0 ²⁾	6.0 ²⁾	6.0 ²⁾	6.0 ²⁾	6.0 ²⁾	6.0 ²⁾	6.0 ²⁾	6.0 ²⁾	
1.5	<0.5 ¹⁾	<0.5 ¹⁾	0.9	1.6	2.7	4.0	6.0 ²⁾	6.0 ²⁾	6.0 ²⁾	6.0 ²⁾	6.0 ²⁾	6.0 ²⁾	
2.0	<0.5 ¹⁾	<0.5 ¹⁾	0.8	1.3	2.1	3.1	6.0 ²⁾	6.0 ²⁾	6.0 ²⁾	6.0 ²⁾	6.0 ²⁾	6.0 ²⁾	
2.5	<0.5 ¹⁾	<0.5 ¹⁾	0.7	1.2	1.8	2.6	4.8	6.0 ²⁾	6.0 ²⁾	6.0 ²⁾	6.0 ²⁾	6.0 ²⁾	
3.0	<0.5 ¹⁾	<0.5 ¹⁾	0.7	1.1	1.7	2.4	4.3	6.0 ²⁾	6.0 ²⁾	6.0 ²⁾	6.0 ²⁾	6.0 ²⁾	
3.5	<0.5 ¹⁾	<0.5 ¹⁾	0.7	1.1	1.7	2.4	4.2	5.6	6.0 ²⁾	6.0 ²⁾	6.0 ²⁾	6.0 ²⁾	
4	<0.5 ¹⁾	<0.5 ¹⁾	0.7	1.0	1.6	2.2	3.8	5.2	6.0 ²⁾	6.0 ²⁾	6.0 ²⁾	6.0 ²⁾	
5		<0.5 ¹⁾	0.6	0.9	1.4	1.9	3.2	4.1	6.0 ²⁾	6.0 ²⁾	6.0 ²⁾	6.0 ²⁾	
6		<0.5 ¹⁾	0.5	0.8	1.2	1.6	2.6	3.3	5.5	6.0 ²⁾	6.0 ²⁾	6.0 ²⁾	
8			0.5	0.8	1.1	1.5	2.2	2.7	4.1	6.0 ²⁾	6.0 ²⁾	6.0 ²⁾	
10				0.5	0.7	1.0	1.3	1.9	2.5	3.6	6.0 ²⁾	6.0 ²⁾	
13					1.0	1.3	1.9	2.3	3.4	6.0 ²⁾	6.0 ²⁾	6.0 ²⁾	
16						1.1	1.6	2.0	3.0	5.5	6.0 ²⁾	6.0 ²⁾	
20							1.4	1.8	2.8	5.0	6.0 ²⁾	6.0 ²⁾	
25								1.8	2.7	4.8	6.0 ²⁾	6.0 ²⁾	
32									2.4	4.1	6.0 ²⁾	6.0 ²⁾	
40										4.0	6.0 ²⁾	6.0 ²⁾	

¹⁾ Selectivity limit current I_s under 0.5 kA

²⁾ Selectivity limit current I_s = rated breaking capacity I_{cn} of the MCB

Darker areas: no selectivity

Let-through Energy PLS4

Let-through Energy PLS4, Characteristic B, 1-pole

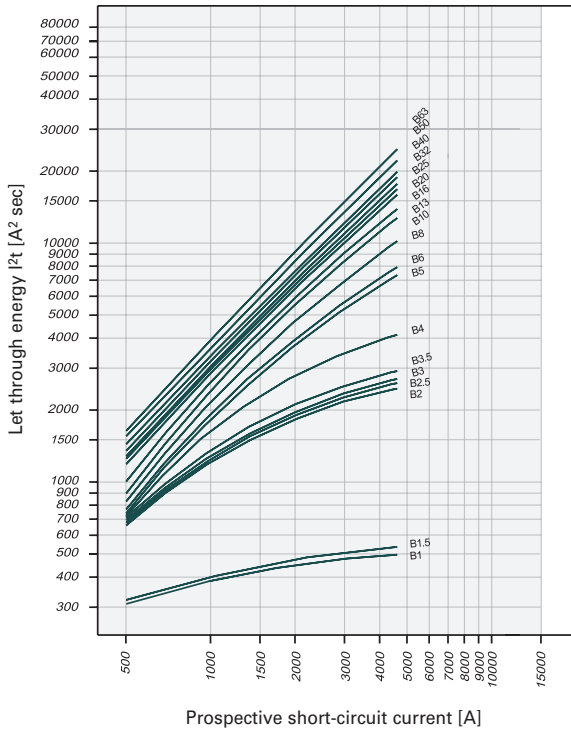

Let-through Energy PLS4, Characteristic C, 1-pole

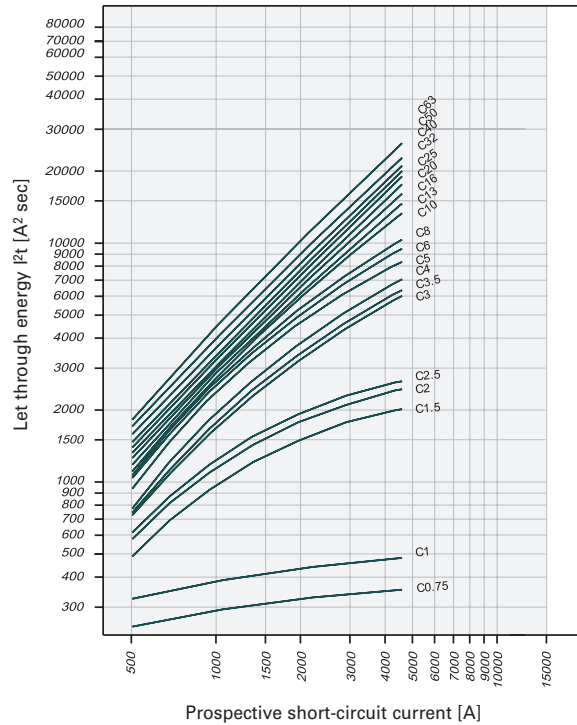

Short-circuit Selectivity PLS4 towards DII-DIV fuse link

In case of short-circuit, there is selectivity between the miniature circuit breakers PLS4 and the upstream fuses up to the specified values of the selectivity limit current I_s [kA] (i. e. in case of short-circuit currents I_{ks} under I_s only the MCB will trip, in case of short-circuit currents above this value both protective devices will respond).

*) basically in accordance with EN 60898-1 D.5.2.b

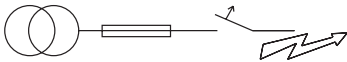

Short-circuit selectivity **Characteristic B** towards fuse link **DII-DIV***

PLS4 I_n [A]	DII-DIV gL/gG										
	10	16	20	25	35	50	63	80	100		
1.0	<0.5 ¹⁾	1.2	4.5 ²⁾	4.5 ²⁾	4.5 ²⁾	4.5 ²⁾	4.5 ²⁾	4.5 ²⁾	4.5 ²⁾		
1.5	<0.5 ¹⁾	1.0	4.5 ²⁾	4.5 ²⁾	4.5 ²⁾	4.5 ²⁾	4.5 ²⁾	4.5 ²⁾	4.5 ²⁾		
2.0	<0.5 ¹⁾	<0.5 ¹⁾	0.8	1.6	4.5 ²⁾	4.5 ²⁾	4.5 ²⁾	4.5 ²⁾	4.5 ²⁾		
2.5	<0.5 ¹⁾	<0.5 ¹⁾	0.8	1.5	4.5 ²⁾	4.5 ²⁾	4.5 ²⁾	4.5 ²⁾	4.5 ²⁾		
3.0	<0.5 ¹⁾	<0.5 ¹⁾	0.8	1.4	4.5 ²⁾	4.5 ²⁾	4.5 ²⁾	4.5 ²⁾	4.5 ²⁾		
3.5	<0.5 ¹⁾	<0.5 ¹⁾	0.7	1.3	4.5 ²⁾	4.5 ²⁾	4.5 ²⁾	4.5 ²⁾	4.5 ²⁾		
4	<0.5 ¹⁾	<0.5 ¹⁾	0.6	1.0	3.6	4.5 ²⁾	4.5 ²⁾	4.5 ²⁾	4.5 ²⁾		
5	<0.5 ¹⁾	<0.5 ¹⁾	0.6	0.9	2.0	3.5	4.5 ²⁾	4.5 ²⁾	4.5 ²⁾		
6		<0.5 ¹⁾	0.6	0.9	1.8	3.2	4.5 ²⁾	4.5 ²⁾	4.5 ²⁾		
8		<0.5 ¹⁾	0.5	0.8	1.6	2.6	4.5 ²⁾	4.5 ²⁾	4.5 ²⁾		
10			0.5	0.8	1.4	2.2	3.9	4.5 ²⁾	4.5 ²⁾		
13			0.5	0.7	1.3	2.0	3.6	4.5 ²⁾	4.5 ²⁾		
16				0.6	1.2	1.9	3.2	4.5 ²⁾	4.5 ²⁾		
20					1.2	1.8	3.1	4.4	4.5 ²⁾		
25						1.2	1.8	3.0	4.2	4.5 ²⁾	
32							1.7	2.8	3.9	4.5 ²⁾	
40								2.7	3.8	4.5 ²⁾	
50									2.5	3.5	4.5 ²⁾
63											4.5 ²⁾

Short-circuit selectivity **Characteristic C** towards fuse link **DII-DIV***

PLS4 I_n [A]	DII-DIV gL/gG										
	10	16	20	25	35	50	63	80	100		
0.75	1.0	4.5 ²⁾	4.5 ²⁾	4.5 ²⁾	4.5 ²⁾	4.5 ²⁾	4.5 ²⁾	4.5 ²⁾	4.5 ²⁾		
1.0	<0.5 ¹⁾	1.2	4.5 ²⁾	4.5 ²⁾	4.5 ²⁾	4.5 ²⁾	4.5 ²⁾	4.5 ²⁾	4.5 ²⁾		
1.5	<0.5 ¹⁾	<0.5 ¹⁾	1.0	2.2	4.5 ²⁾	4.5 ²⁾	4.5 ²⁾	4.5 ²⁾	4.5 ²⁾		
2.0	<0.5 ¹⁾	<0.5 ¹⁾	0.8	1.6	4.5 ²⁾	4.5 ²⁾	4.5 ²⁾	4.5 ²⁾	4.5 ²⁾		
2.5	<0.5 ¹⁾	<0.5 ¹⁾	0.8	1.4	4.5 ²⁾	4.5 ²⁾	4.5 ²⁾	4.5 ²⁾	4.5 ²⁾		
3.0	<0.5 ¹⁾	<0.5 ¹⁾	0.8	0.9	4.5 ²⁾	4.5 ²⁾	4.5 ²⁾	4.5 ²⁾	4.5 ²⁾		
3.5	<0.5 ¹⁾	<0.5 ¹⁾	0.6	0.9	2.2	4.5 ²⁾	4.5 ²⁾	4.5 ²⁾	4.5 ²⁾		
4	<0.5 ¹⁾	<0.5 ¹⁾	0.6	0.8	1.8	3.6	4.5 ²⁾	4.5 ²⁾	4.5 ²⁾		
5	<0.5 ¹⁾	<0.5 ¹⁾	0.6	0.7	1.5	2.7	4.5 ²⁾	4.5 ²⁾	4.5 ²⁾		
6		<0.5 ¹⁾	0.5	0.6	1.4	2.4	4.5 ²⁾	4.5 ²⁾	4.5 ²⁾		
8		<0.5 ¹⁾	<0.5 ¹⁾	0.6	1.3	2.2	4.5 ²⁾	4.5 ²⁾	4.5 ²⁾		
10			<0.5 ¹⁾	0.6	1.3	2.0	3.6	4.5 ²⁾	4.5 ²⁾		
13					1.3	1.9	3.3	4.5 ²⁾	4.5 ²⁾		
16						1.2	1.8	3.2	4.4	4.5 ²⁾	
20							1.2	1.8	3.1	4.1	4.5 ²⁾
25								1.7	2.8	3.8	4.5 ²⁾
32									2.7	3.7	4.5 ²⁾
40										3.5	4.5 ²⁾
50											4.5 ²⁾
63											4.5 ²⁾

¹⁾ Selectivity limit current I_s under 0.5 kA

²⁾ Selectivity limit current I_s = rated breaking capacity I_{cn} of the MCB

Darker areas: no selectivity

Short-circuit Selectivity PLS4 towards D01-D03 fuse link

In case of short-circuit, there is selectivity between the miniature circuit breakers PLS4 and the upstream fuses up to the specified values of the selectivity limit current I_s [kA] (i. e. in case of short-circuit currents I_{ks} under I_s only the MCB will trip, in case of short-circuit currents above this value both protective devices will respond).

*) basically in accordance with EN 60898-1 D.5.2.b

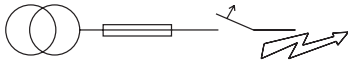

Short-circuit selectivity **Characteristic B** towards fuse link **D01-D03***)

PLS4	D01-D03 gL/gG									
I_n [A]	10	16	20	25	35	50	63	80	100	
1.0	<0.5 ¹⁾	4.5 ²⁾	4.5 ²⁾	4.5 ²⁾	4.5 ²⁾	4.5 ²⁾	4.5 ²⁾	4.5 ²⁾	4.5 ²⁾	4.5 ²⁾
1.5	<0.5 ¹⁾	4.1	4.5 ²⁾	4.5 ²⁾	4.5 ²⁾	4.5 ²⁾	4.5 ²⁾	4.5 ²⁾	4.5 ²⁾	4.5 ²⁾
2.0	<0.5 ¹⁾	<0.5 ¹⁾	0.6	1.0	4.5 ²⁾	4.5 ²⁾	4.5 ²⁾	4.5 ²⁾	4.5 ²⁾	4.5 ²⁾
2.5	<0.5 ¹⁾	<0.5 ¹⁾	0.6	1.0	4.5 ²⁾	4.5 ²⁾	4.5 ²⁾	4.5 ²⁾	4.5 ²⁾	4.5 ²⁾
3.0	<0.5 ¹⁾	<0.5 ¹⁾	0.5	1.0	4.5 ²⁾	4.5 ²⁾	4.5 ²⁾	4.5 ²⁾	4.5 ²⁾	4.5 ²⁾
3.5	<0.5 ¹⁾	<0.5 ¹⁾	0.5	0.9	4.5 ²⁾	4.5 ²⁾	4.5 ²⁾	4.5 ²⁾	4.5 ²⁾	4.5 ²⁾
4	<0.5 ¹⁾	<0.5 ¹⁾	0.5	0.9	2.5	4.5 ²⁾	4.5 ²⁾	4.5 ²⁾	4.5 ²⁾	4.5 ²⁾
5		<0.5 ¹⁾	0.5	0.8	1.7	4.0	4.5 ²⁾	4.5 ²⁾	4.5 ²⁾	4.5 ²⁾
6		<0.5 ¹⁾	0.5	0.8	1.6	3.6	4.5 ²⁾	4.5 ²⁾	4.5 ²⁾	4.5 ²⁾
8			0.5	0.8	1.4	2.8	4.3	4.5 ²⁾	4.5 ²⁾	4.5 ²⁾
10			0.5	0.7	1.3	2.4	3.4	4.5 ²⁾	4.5 ²⁾	4.5 ²⁾
13			<0.5 ¹⁾	0.7	1.2	2.3	3.2	4.5 ²⁾	4.5 ²⁾	4.5 ²⁾
16				0.6	1.1	2.2	2.9	4.5 ²⁾	4.5 ²⁾	4.5 ²⁾
20					1.1	2.1	2.8	4.4	4.5 ²⁾	4.5 ²⁾
25					1.1	2.0	2.7	4.2	4.5 ²⁾	4.5 ²⁾
32						2.0	2.6	4.0	4.5 ²⁾	4.5 ²⁾
40							2.5	3.8	4.5 ²⁾	4.5 ²⁾
50							2.3	3.4	4.5 ²⁾	4.5 ²⁾
63									4.5 ²⁾	4.5 ²⁾

Short-circuit selectivity **Characteristic C** towards fuse link **D01-D03***)

PLS4	D01-D03 gL/gG									
I_n [A]	10	16	20	25	35	50	63	80	100	
0.75	<0.5 ¹⁾	4.5 ²⁾	4.5 ²⁾	4.5 ²⁾	4.5 ²⁾	4.5 ²⁾	4.5 ²⁾	4.5 ²⁾	4.5 ²⁾	4.5 ²⁾
1.0	<0.5 ¹⁾	4.5 ²⁾	4.5 ²⁾	4.5 ²⁾	4.5 ²⁾	4.5 ²⁾	4.5 ²⁾	4.5 ²⁾	4.5 ²⁾	4.5 ²⁾
1.5	<0.5 ¹⁾	0.5	0.6	0.9	4.5 ²⁾	4.5 ²⁾	4.5 ²⁾	4.5 ²⁾	4.5 ²⁾	4.5 ²⁾
2.0	<0.5 ¹⁾	<0.5 ¹⁾	0.5	0.7	4.5 ²⁾	4.5 ²⁾	4.5 ²⁾	4.5 ²⁾	4.5 ²⁾	4.5 ²⁾
2.5	<0.5 ¹⁾	<0.5 ¹⁾	0.5	0.7	4.5 ²⁾	4.5 ²⁾	4.5 ²⁾	4.5 ²⁾	4.5 ²⁾	4.5 ²⁾
3.0	<0.5 ¹⁾	<0.5 ¹⁾	<0.5 ¹⁾	0.6	1.9	4.5 ²⁾	4.5 ²⁾	4.5 ²⁾	4.5 ²⁾	4.5 ²⁾
3.5	<0.5 ¹⁾	<0.5 ¹⁾	<0.5 ¹⁾	0.6	1.8	4.5 ²⁾	4.5 ²⁾	4.5 ²⁾	4.5 ²⁾	4.5 ²⁾
4	<0.5 ¹⁾	<0.5 ¹⁾	<0.5 ¹⁾	0.6	1.6	4.0	4.5 ²⁾	4.5 ²⁾	4.5 ²⁾	4.5 ²⁾
5		<0.5 ¹⁾	<0.5 ¹⁾	0.5	1.3	3.1	4.5 ²⁾	4.5 ²⁾	4.5 ²⁾	4.5 ²⁾
6		<0.5 ¹⁾	<0.5 ¹⁾	<0.5 ¹⁾	1.2	2.7	4.5 ²⁾	4.5 ²⁾	4.5 ²⁾	4.5 ²⁾
8		<0.5 ¹⁾	<0.5 ¹⁾	<0.5 ¹⁾	1.2	2.5	4.0	4.5 ²⁾	4.5 ²⁾	4.5 ²⁾
10			<0.5 ¹⁾	<0.5 ¹⁾	1.2	2.3	3.1	4.5 ²⁾	4.5 ²⁾	4.5 ²⁾
13					1.1	2.2	3.0	4.5 ²⁾	4.5 ²⁾	4.5 ²⁾
16					1.1	2.1	2.8	4.4	4.5 ²⁾	4.5 ²⁾
20					1.0	2.0	2.6	4.0	4.5 ²⁾	4.5 ²⁾
25						1.9	2.5	3.8	4.5 ²⁾	4.5 ²⁾
32							2.5	3.7	4.5 ²⁾	4.5 ²⁾
40								3.5	4.5 ²⁾	4.5 ²⁾
50									4.5 ²⁾	4.5 ²⁾
63										4.5 ²⁾

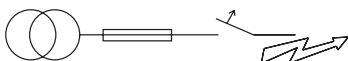

Short-circuit selectivity **Characteristic B** towards fuse link **NH-00***)

PLS4	NH-00 gL/gG												
I_n [A]	16	20	25	32	35	40	50	63	80	100	125	160	
1.0	0.9	4.5 ²⁾	4.5 ²⁾	4.5 ²⁾	4.5 ²⁾	4.5 ²⁾	4.5 ²⁾	4.5 ²⁾	4.5 ²⁾	4.5 ²⁾	4.5 ²⁾	4.5 ²⁾	4.5 ²⁾
1.5	0.8	4.5 ²⁾	4.5 ²⁾	4.5 ²⁾	4.5 ²⁾	4.5 ²⁾	4.5 ²⁾	4.5 ²⁾	4.5 ²⁾	4.5 ²⁾	4.5 ²⁾	4.5 ²⁾	4.5 ²⁾
2.0	<0.5 ¹⁾	0.5	1.0	2.5	4.5 ²⁾	4.5 ²⁾	4.5 ²⁾	4.5 ²⁾	4.5 ²⁾	4.5 ²⁾	4.5 ²⁾	4.5 ²⁾	4.5 ²⁾
2.5	<0.5 ¹⁾	0.5	1.0	2.3	4.5 ²⁾	4.5 ²⁾	4.5 ²⁾	4.5 ²⁾	4.5 ²⁾	4.5 ²⁾	4.5 ²⁾	4.5 ²⁾	4.5 ²⁾
3.0	<0.5 ¹⁾	0.5	0.9	2.1	4.5 ²⁾	4.5 ²⁾	4.5 ²⁾	4.5 ²⁾	4.5 ²⁾	4.5 ²⁾	4.5 ²⁾	4.5 ²⁾	4.5 ²⁾
3.5	<0.5 ¹⁾	0.5	0.9	1.8	4.5 ²⁾	4.5 ²⁾	4.5 ²⁾	4.5 ²⁾	4.5 ²⁾	4.5 ²⁾	4.5 ²⁾	4.5 ²⁾	4.5 ²⁾
4	<0.5 ¹⁾	<0.5 ¹⁾	0.8	1.3	2.3	4.3	4.5 ²⁾	4.5 ²⁾	4.5 ²⁾	4.5 ²⁾	4.5 ²⁾	4.5 ²⁾	4.5 ²⁾
5	<0.5 ¹⁾	<0.5 ¹⁾	0.7	1.1	1.6	2.2	3.6	4.5 ²⁾	4.5 ²⁾	4.5 ²⁾	4.5 ²⁾	4.5 ²⁾	4.5 ²⁾
6	<0.5 ¹⁾	<0.5 ¹⁾	0.7	1.1	1.5	2.0	3.3	4.3	4.5 ²⁾	4.5 ²⁾	4.5 ²⁾	4.5 ²⁾	4.5 ²⁾
8	<0.5 ¹⁾	<0.5 ¹⁾	0.6	1.0	1.3	1.7	2.6	3.3	4.5 ²⁾	4.5 ²⁾	4.5 ²⁾	4.5 ²⁾	4.5 ²⁾
10		<0.5 ¹⁾	0.6	0.9	1.2	1.5	2.2	2.7	4.0	4.5 ²⁾	4.5 ²⁾	4.5 ²⁾	4.5 ²⁾
13		<0.5 ¹⁾	0.6	0.8	1.1	1.4	2.1	2.6	3.8	4.5 ²⁾	4.5 ²⁾	4.5 ²⁾	4.5 ²⁾
16			0.5	0.7	1.0	1.3	1.9	2.4	3.4	4.5 ²⁾	4.5 ²⁾	4.5 ²⁾	4.5 ²⁾
20				0.7	1.0	1.3	1.9	2.4	3.3	4.5 ²⁾	4.5 ²⁾	4.5 ²⁾	4.5 ²⁾
25				0.7	1.0	1.3	1.8	2.3	3.2	4.5 ²⁾	4.5 ²⁾	4.5 ²⁾	4.5 ²⁾
32					0.9	1.2	1.7	2.2	3.1	4.5 ²⁾	4.5 ²⁾	4.5 ²⁾	4.5 ²⁾
40							2.1	3.0	4.5 ²⁾	4.5 ²⁾	4.5 ²⁾	4.5 ²⁾	4.5 ²⁾
50								1.9	2.8	4.5 ²⁾	4.5 ²⁾	4.5 ²⁾	4.5 ²⁾
63									4.4	4.5 ²⁾	4.5 ²⁾	4.5 ²⁾	4.5 ²⁾

Short-circuit selectivity **Characteristic C** towards fuse link **NH-00***)

PLS4	NH-00 gL/gG												
I_n [A]	16	20	25	32	35	40	50	63	80	100	125	160	
0.75	4.5 ²⁾	4.5 ²⁾	4.5 ²⁾	4.5 ²⁾	4.5 ²⁾	4.5 ²⁾	4.5 ²⁾	4.5 ²⁾	4.5 ²⁾	4.5 ²⁾	4.5 ²⁾	4.5 ²⁾	4.5 ²⁾
1.0	0.9	4.5 ²⁾	4.5 ²⁾	4.5 ²⁾	4.5 ²⁾	4.5 ²⁾	4.5 ²⁾	4.5 ²⁾	4.5 ²⁾	4.5 ²⁾	4.5 ²⁾	4.5 ²⁾	4.5 ²⁾
1.5	<0.5 ¹⁾	0.6	1.3	4.2	4.5 ²⁾	4.5 ²⁾	4.5 ²⁾	4.5 ²⁾	4.5 ²⁾	4.5 ²⁾	4.5 ²⁾	4.5 ²⁾	4.5 ²⁾
2.0	<0.5 ¹⁾	0.6	1.0	2.5	4.5 ²⁾	4.5 ²⁾	4.5 ²⁾	4.5 ²⁾	4.5 ²⁾	4.5 ²⁾	4.5 ²⁾	4.5 ²⁾	4.5 ²⁾
2.5	<0.5 ¹⁾	0.5	1.0	2.1	4.5 ²⁾	4.5 ²⁾	4.5 ²⁾	4.5 ²⁾	4.5 ²⁾	4.5 ²⁾	4.5 ²⁾	4.5 ²⁾	4.5 ²⁾
3.0	<0.5 ¹⁾	<0.5 ¹⁾	0.7	1.2	1.8	2.6	4.5 ²⁾	4.5 ²⁾	4.5 ²⁾	4.5 ²⁾	4.5 ²⁾	4.5 ²⁾	4.5 ²⁾
3.5	<0.5 ¹⁾	<0.5 ¹⁾	0.7	1.1	1.7	2.4	4.2	4.5 ²⁾	4.5 ²⁾	4.5 ²⁾	4.5 ²⁾	4.5 ²⁾	4.5 ²⁾
4	<0.5 ¹⁾	<0.5 ¹⁾	0.7	1.0	1.5	2.1	3.6	4.5 ²⁾	4.5 ²⁾	4.5 ²⁾	4.5 ²⁾	4.5 ²⁾	4.5 ²⁾
5	<0.5 ¹⁾	<0.5 ¹⁾	0.6	0.8	1.2	1.7	2.8	3.8	4.5 ²⁾	4.5 ²⁾	4.5 ²⁾	4.5 ²⁾	4.5 ²⁾
6	<0.5 ¹⁾	<0.5 ¹⁾	0.5	0.8	1.2	1.5	2.5	3.3	4.5 ²⁾	4.5 ²⁾	4.5 ²⁾	4.5 ²⁾	4.5 ²⁾
8	<0.5 ¹⁾	<0.5 ¹⁾	0.5	0.8	1.1	1.5	2.3	2.9	4.5 ²⁾	4.5 ²⁾	4.5 ²⁾	4.5 ²⁾	4.5 ²⁾
10			0.5	0.7	1.0	1.4	2.0	2.5	3.8	4.5 ²⁾	4.5 ²⁾	4.5 ²⁾	4.5 ²⁾
13					1.0	1.3	1.9	2.4	3.6	4.5 ²⁾	4.5 ²⁾	4.5 ²⁾	4.5 ²⁾
16					1.0	1.3	1.8	2.3	3.3	4.5 ²⁾	4.5 ²⁾	4.5 ²⁾	4.5 ²⁾
20					1.0	1.2	1.7	2.2	3.2	4.5 ²⁾	4.5 ²⁾	4.5 ²⁾	4.5 ²⁾
25						1.6	2.1	3.0	4.5 ²⁾	4.5 ²⁾	4.5 ²⁾	4.5 ²⁾	4.5 ²⁾
32							2.1	2.9	4.5 ²⁾	4.5 ²⁾	4.5 ²⁾	4.5 ²⁾	4.5 ²⁾
40								2.8	4.5 ²⁾	4.5 ²⁾	4.5 ²⁾	4.5 ²⁾	4.5 ²⁾
50									4.5 ²⁾	4.5 ²⁾	4.5 ²⁾	4.5 ²⁾	4.5 ²⁾
63										4.5 ²⁾	4.5 ²⁾	4.5 ²⁾	4.5 ²⁾

SG45311



Description

- High-quality miniature circuit breakers for DC-applications
- Contact position indicator red - green
- Guide for secure terminal connection
- 3-position DIN rail clip, permits removal from existing busbar system
- Comprehensive range of accessories can be mounted subsequently
- Rated currents up to 50 A
- Tripping Characteristic C
- Rated breaking capacity 10 kA according to IEC/EN 60947-2
- Up to 250 V DC per pole

1.5

Miniature Circuit Breakers (MCBs)

xPole

Miniature Circuit Breakers PLS6-DC for direct current application (MW)

SG48311



Rated current I_n (A)	Type Designation	Article No.	Units per package
10 kA, Characteristic C			
1-pole			
1	PLS6-C1-DC	243115	12/120
2	PLS6-C2-DC	243116	12/120
3	PLS6-C3-DC	243117	12/120
4	PLS6-C4-DC	243118	12/120
6	PLS6-C6-DC	243119	12/120
10	PLS6-C10-DC	243120	12/120
13	PLS6-C13-DC	243121	12/120
16	PLS6-C16-DC	243122	12/120
20	PLS6-C20-DC	243123	12/120
25	PLS6-C25-DC	243124	12/120
32	PLS6-C32-DC	243125	12/120
40	PLS6-C40-DC	243126	12/120
50	PLS6-C50-DC	243127	12/120

SG55411



2-pole			
1	PLS6-C1/2-DC	243128	1/60
2	PLS6-C2/2-DC	243129	1/60
3	PLS6-C3/2-DC	243130	1/60
4	PLS6-C4/2-DC	243131	1/60
6	PLS6-C6/2-DC	243132	1/60
10	PLS6-C10/2-DC	243133	1/60
13	PLS6-C13/2-DC	243134	1/60
16	PLS6-C16/2-DC	243135	1/60
20	PLS6-C20/2-DC	243136	1/60
25	PLS6-C25/2-DC	243137	1/60
32	PLS6-C32/2-DC	243138	1/60
40	PLS6-C40/2-DC	243139	1/60
50	PLS6-C50/2-DC	243140	1/60

Specifications | Miniature Circuit Breakers PLS6-DC

Description

- High selectivity between MCB and back-up fuse due to low let-through energy
- Compatible with standard busbar
- Twin-purpose terminal (lift/open-mouthed) above and below
- Busbar positioning optionally above or below
- Meets the requirements of insulation co-ordination, distance between contacts ≥ 4 mm, for secure isolation
- Rated breaking capacity 10 kA according to IEC/EN 60947
- Rated voltage to 250 V (per pole), $\tau = 4$ ms
- Take into account polarity!

Accessories:

Auxiliary switch for subsequent installation	ZP-IHK	286052
	ZP-WHK	286053
Tripping signal switch for subsequent installation	ZP-NHK	248437
Remote control and automatic switching device	Z-FW/LP	248296
Shunt trip release	ZP-ASA/..	248438, 248439
Undervoltage release	Z-USA/..	248288-248291
Additional terminal 35 mm ²	BB-UL-TEPA/35	169823
Switching interlock	Z-IS/SPE-1TE	274418

Technical Data

		PLS6-DC
Electrical		
Design according to		IEC/EN 60947-2
Current test marks as printed onto the device		
Rated voltage DC		1-2 A types: 220 V (per pole) 3-50 A types: 250 V (per pole)
Rated frequency		50/60 Hz
Rated breaking capacity according to IEC/EN 60947-2		10 kA
Characteristic		C
Back-up fuse		max. 100 A gL
Selectivity class		3
Rated impulse withstand voltage	U_{imp}	4 kV (1.2/50 μ s)
Endurance		
electrical components		$\geq 4,000$ switching operations
mechanical components		$\geq 20,000$ switching operations
Line voltage connection		at will (above/below)
Mechanical		
Frame size		45 mm
Device height		80 mm
Device width		17.5 mm per pole (1MU)
Mounting		quick fastening with 3 lock-in positions on DIN rail IEC/EN 60715
Degree of protection		IP20
Upper and lower terminals		open-mouthed/lift terminals
Terminal protection		finger and hand touch safe, DGUV VS3, EN 50274
Terminal capacity		1-25 mm ²
Terminal torque		2-2.4 Nm
Busbar thickness		0.8 - 2 mm
Mounting		independent of position
Operation temperature		-25°C to +55°C
Storage- and transport temperature		-40°C up to +60°C

Note: not for PV string protection!

Connection diagrams

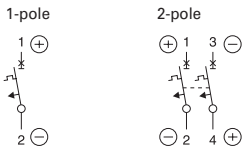

Dimensions (mm)

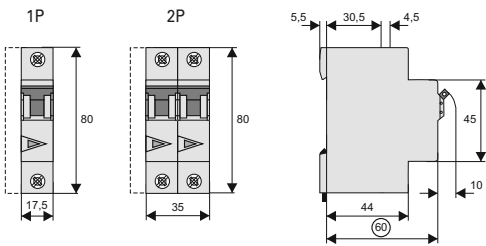

Connection examples

Connection example at 250 V=, 1-pole

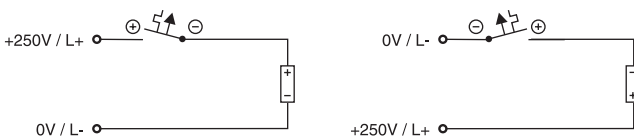

Connection example at 500 V=, 2-pole

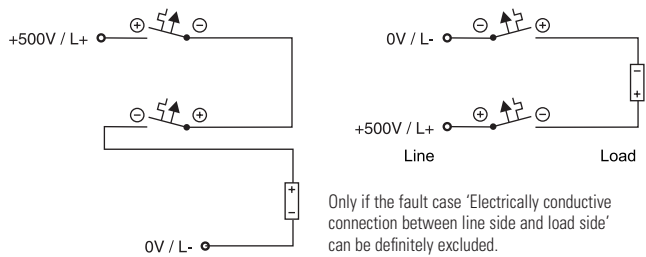

Tripping characteristic PLS6-DC

Type C

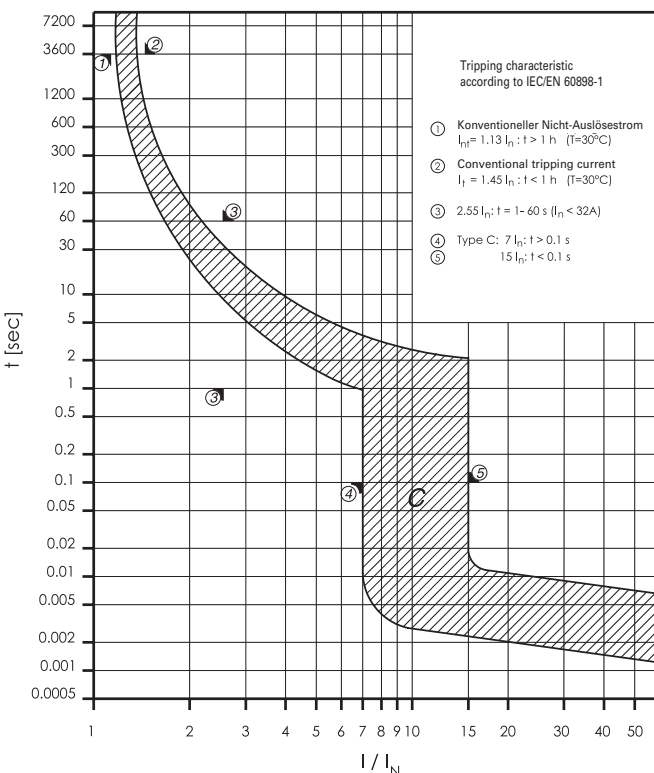

Let-through Energy PLS6-DC

Type C, 250 V d.c., $\tau = 5$ ms (according to IEC/EN 60947-2)

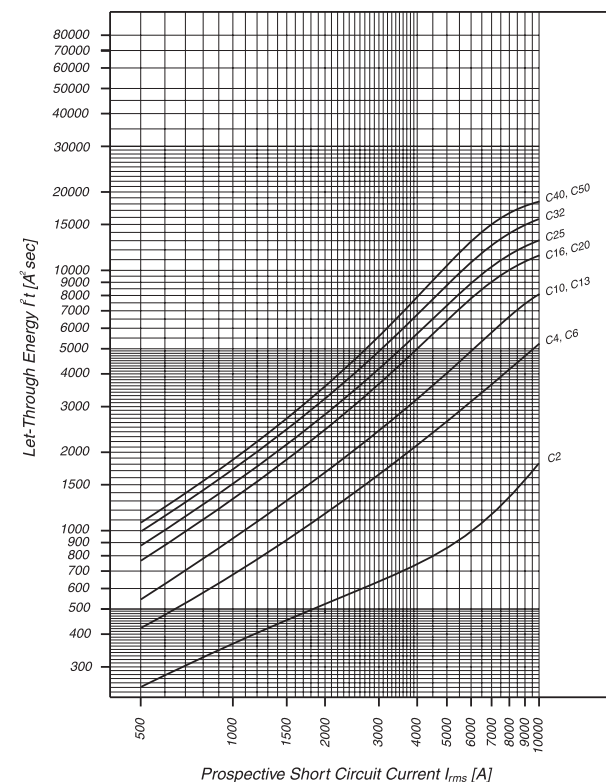

SG06511



Description

- High-quality miniature circuit breakers for commercial and residential applications
- Contact position indicator red - green
- Guide for secure terminal connection
- 3-position DIN rail clip, permits removal from existing busbar system
- Comprehensive range of accessories can be mounted subsequently
- Rated currents up to 63 A
- Tripping characteristics B, C, D
- Rated breaking capacity 10 kA according to IEC/EN 60898-1

SG06211



Rated current I_n (A)	Type Designation	Article No.	Units per package
----------------------------	---------------------	-------------	----------------------

10 kA, Characteristic B

1-pole

1	PL7-B1/1	165052	12/120
2	PL7-B2/1	264839	12/120
3	PL7-B3/1	165055	12/120
4	PL7-B4/1	264850	12/120
6	PL7-B6/1	262673	12/120
10	PL7-B10/1	262674	12/120
13	PL7-B13/1	262675	12/120
16	PL7-B16/1	262676	12/120
20	PL7-B20/1	262677	12/120
25	PL7-B25/1	262678	12/120
32	PL7-B32/1	262679	12/120
40	PL7-B40/1	262690	12/120
50	PL7-B50/1	262691	12/120
63	PL7-B63/1	262692	12/120

SG06311



1+N-pole

1	PL7-B1/1N	165214	8/80
2	PL7-B2/1N	165218	8/80
3	PL7-B3/1N	165220	8/80
4	PL7-B4/1N	165221	8/80
6	PL7-B6/1N	262727	8/80
10	PL7-B10/1N	262728	8/80
13	PL7-B13/1N	262729	8/80
16	PL7-B16/1N	262740	8/80
20	PL7-B20/1N	262741	8/80
25	PL7-B25/1N	262742	8/80
32	PL7-B32/1N	262743	8/80

SG06411



Rated current I_n (A)	Type Designation	Article No.	Units per package
2-pole			
1	PL7-B1/2	165079	6/60
2	PL7-B2/2	165083	6/60
3	PL7-B3/2	165085	6/60
4	PL7-B4/2	165086	6/60
6	PL7-B6/2	262761	6/60
10	PL7-B10/2	262762	6/60
13	PL7-B13/2	262764	6/60
16	PL7-B16/2	262765	6/60
20	PL7-B20/2	262766	6/60
25	PL7-B25/2	262767	6/60
32	PL7-B32/2	262768	6/60
40	PL7-B40/2	262769	6/60
50	PL7-B50/2	263350	6/60
63	PL7-B63/2	263351	6/60

SG06511



Rated current I_n (A)	Type Designation	Article No.	Units per package
3-pole			
1	PL7-B1/3	165112	4/40
2	PL7-B2/3	165116	4/40
3	PL7-B3/3	165118	4/40
4	PL7-B4/3	116709	4/40
6	PL7-B6/3	263386	4/40
10	PL7-B10/3	263387	4/40
13	PL7-B13/3	263388	4/40
16	PL7-B16/3	263389	4/40
20	PL7-B20/3	263390	4/40
25	PL7-B25/3	263391	4/40
32	PL7-B32/3	263392	4/40
40	PL7-B40/3	263393	4/40
50	PL7-B50/3	263400	4/40
63	PL7-B63/3	263401	4/40

1.5

Miniature Circuit Breakers (MCBs)

xPole

Miniature Circuit Breakers PL7

SG06711



Rated current I_n (A)	Type Designation	Article No.	Units per package
3+N-pole			
1	PL7-B1/3N	165251	3/30
2	PL7-B2/3N	165255	3/30
3	PL7-B3/3N	165257	3/30
4	PL7-B4/3N	165258	3/30
6	PL7-B6/3N	263982	3/30
10	PL7-B10/3N	263983	3/30
13	PL7-B13/3N	263984	3/30
16	PL7-B16/3N	263985	3/30
20	PL7-B20/3N	263986	3/30
25	PL7-B25/3N	263987	3/30
32	PL7-B32/3N	263988	3/30
40	PL7-B40/3N	263989	3/30
50	PL7-B50/3N	263990	3/30
63	PL7-B63/3N	263991	3/30

SG06611



Rated current I_n (A)	Type Designation	Article No.	Units per package
4-pole			
1	PL7-B1/4	165146	3/30
2	PL7-B2/4	165153	3/30
3	PL7-B3/4	165157	3/30
4	PL7-B4/4	165159	3/30
6	PL7-B6/4	165163	3/30
10	PL7-B10/4	165147	3/30
13	PL7-B13/4	165149	3/30
16	PL7-B16/4	165151	3/30
20	PL7-B20/4	165154	3/30
25	PL7-B25/4	165155	3/30
32	PL7-B32/4	165158	3/30
40	PL7-B40/4	165160	3/30
50	PL7-B50/4	165162	3/30
63	PL7-B63/4	165164	3/30

Rated current I_n (A)	Type Designation	Article No.	Units per package
----------------------------	---------------------	-------------	----------------------

10 kA, Characteristic C

SG06211



1-pole

1	PL7-C1/1	262697	12/120
2	PL7-C2/1	262699	12/120
3	PL7-C3/1	165063	12/120
4	PL7-C4/1	262700	12/120
6	PL7-C6/1	262701	12/120
10	PL7-C10/1	262702	12/120
13	PL7-C13/1	262703	12/120
16	PL7-C16/1	262704	12/120
20	PL7-C20/1	262705	12/120
25	PL7-C25/1	262706	12/120
32	PL7-C32/1	262707	12/120
40	PL7-C40/1	262708	12/120
50	PL7-C50/1	262709	12/120
63	PL7-C63/1	262710	12/120

SG06311



1+N-pole

1	PL7-C1/1N	165230	8/80
2	PL7-C2/1N	262744	8/80
3	PL7-C3/1N	165235	8/80
4	PL7-C4/1N	262745	8/80
6	PL7-C6/1N	262746	8/80
10	PL7-C10/1N	262747	8/80
13	PL7-C13/1N	262748	8/80
16	PL7-C16/1N	262749	8/80
20	PL7-C20/1N	262750	8/80
25	PL7-C25/1N	262751	8/80
32	PL7-C32/1N	262752	8/80

1.5

Miniature Circuit Breakers (MCBs)

xPole

Miniature Circuit Breakers PL7

SG06411



Rated current I_n (A)	Type Designation	Article No.	Units per package
2-pole			
1	PL7-C1/2	263353	6/60
2	PL7-C2/2	263354	6/60
3	PL7-C3/2	165098	6/60
4	PL7-C4/2	263355	6/60
6	PL7-C6/2	263356	6/60
10	PL7-C10/2	263357	6/60
13	PL7-C13/2	263358	6/60
16	PL7-C16/2	263359	6/60
20	PL7-C20/2	263360	6/60
25	PL7-C25/2	263361	6/60
32	PL7-C32/2	263362	6/60
40	PL7-C40/2	263363	6/60
50	PL7-C50/2	263364	6/60
63	PL7-C63/2	263365	6/60

SG06511



Rated current I_n (A)	Type Designation	Article No.	Units per package
3-pole			
1	PL7-C1/3	263403	4/40
2	PL7-C2/3	263404	4/40
3	PL7-C3/3	165130	4/40
4	PL7-C4/3	263405	4/40
6	PL7-C6/3	263406	4/40
10	PL7-C10/3	263407	4/40
13	PL7-C13/3	263408	4/40
16	PL7-C16/3	263409	4/40
20	PL7-C20/3	263410	4/40
25	PL7-C25/3	263411	4/40
32	PL7-C32/3	263412	4/40
40	PL7-C40/3	263413	4/40
50	PL7-C50/3	263414	4/40
63	PL7-C63/3	263415	4/40

SG06711



Rated current
 I_n (A)

Type
Designation

Article No.

Units per
package

3+N-pole

Rated current I_n (A)	Type Designation	Article No.	Units per package
1	PL7-C1/3N	165267	3/30
2	PL7-C2/3N	165271	3/30
3	PL7-C3/3N	165273	3/30
4	PL7-C4/3N	165274	3/30
6	PL7-C6/3N	263992	3/30
10	PL7-C10/3N	263993	3/30
13	PL7-C13/3N	263994	3/30
16	PL7-C16/3N	263995	3/30
20	PL7-C20/3N	263996	3/30
25	PL7-C25/3N	263997	3/30
32	PL7-C32/3N	263998	3/30
40	PL7-C40/3N	263999	3/30
50	PL7-C50/3N	264000	3/30
63	PL7-C63/3N	264001	3/30

SG06611



4-pole

Rated current I_n (A)	Type Designation	Article No.	Units per package
1	PL7-C1/4	165172	3/30
2	PL7-C2/4	165178	3/30
3	PL7-C3/4	165182	3/30
4	PL7-C4/4	165184	3/30
6	PL7-C6/4	165188	3/30
10	PL7-C10/4	165173	3/30
13	PL7-C13/4	165175	3/30
16	PL7-C16/4	107329	3/30
20	PL7-C20/4	165179	3/30
25	PL7-C25/4	165180	3/30
32	PL7-C32/4	165183	3/30
40	PL7-C40/4	165185	3/30
50	PL7-C50/4	165187	3/30
63	PL7-C63/4	165189	3/30

Rated current I_n (A)	Type Designation	Article No.	Units per package
----------------------------	---------------------	-------------	----------------------

10 kA, Characteristic D

1-pole

1	PL7-D1/1	165071	12/120
2	PL7-D2/1	262711	12/120
3	PL7-D3/1	165074	12/120
4	PL7-D4/1	262712	12/120
6	PL7-D6/1	262713	12/120
10	PL7-D10/1	262714	12/120
13	PL7-D13/1	262715	12/120
16	PL7-D16/1	262716	12/120
20	PL7-D20/1	262717	12/120
25	PL7-D25/1	262718	12/120
32	PL7-D32/1	262719	12/120
40	PL7-D40/1	262720	12/120

SG06211



1+N-pole

1	PL7-D1/1N	165241	8/80
2	PL7-D2/1N	262753	8/80
3	PL7-D3/1N	165246	8/80
4	PL7-D4/1N	262754	8/80
6	PL7-D6/1N	262755	8/80
10	PL7-D10/1N	262756	8/80
13	PL7-D13/1N	262757	8/80
16	PL7-D16/1N	262758	8/80
20	PL7-D20/1N	262759	8/80
25	PL7-D25/1N	262760	8/80

SG06311



SG06411



Rated current I_n (A)	Type Designation	Article No.	Units per package
2-pole			
1	PL7-D1/2	108184	6/60
2	PL7-D2/2	263366	6/60
3	PL7-D3/2	108185	6/60
4	PL7-D4/2	263367	6/60
6	PL7-D6/2	263368	6/60
10	PL7-D10/2	263369	6/60
13	PL7-D13/2	263380	6/60
16	PL7-D16/2	263381	6/60
20	PL7-D20/2	263382	6/60
25	PL7-D25/2	263383	6/60
32	PL7-D32/2	263384	6/60
40	PL7-D40/2	263385	6/60

1.5

Miniature Circuit Breakers (MCBs)

xPole

Miniature Circuit Breakers PL7

SG06511



Rated current I_n (A)	Type Designation	Article No.	Units per package
3-pole			
1	PL7-D1/3	165136	4/40
2	PL7-D2/3	263416	4/40
3	PL7-D3/3	165141	4/40
4	PL7-D4/3	263417	4/40
6	PL7-D6/3	263418	4/40
10	PL7-D10/3	263419	4/40
13	PL7-D13/3	263420	4/40
16	PL7-D16/3	263421	4/40
20	PL7-D20/3	263422	4/40
25	PL7-D25/3	263423	4/40
32	PL7-D32/3	263424	4/40
40	PL7-D40/3	263425	4/40

SG06711



Rated current I_n (A)	Type Designation	Article No.	Units per package
3+N-pole			
1	PL7-D1/3N	165280	3/30
2	PL7-D2/3N	165284	3/30
3	PL7-D3/3N	165286	3/30
4	PL7-D4/3N	165287	3/30
6	PL7-D6/3N	264002	3/30
10	PL7-D10/3N	264003	3/30
13	PL7-D13/3N	264004	3/30
16	PL7-D16/3N	264005	3/30
20	PL7-D20/3N	264006	3/30
25	PL7-D25/3N	264007	3/30
32	PL7-D32/3N	264008	3/30
40	PL7-D40/3N	264009	3/30

SG06611



Rated current I_n (A)	Type Designation	Article No.	Units per package
4-pole			
1	PL7-D1/4	165194	3/30
2	PL7-D2/4	165201	3/30
3	PL7-D3/4	165205	3/30
4	PL7-D4/4	165207	3/30
6	PL7-D6/4	165210	3/30
10	PL7-D10/4	165195	3/30
13	PL7-D13/4	165197	3/30
16	PL7-D16/4	165199	3/30
20	PL7-D20/4	165202	3/30
25	PL7-D25/4	165203	3/30
32	PL7-D32/4	165206	3/30
40	PL7-D40/4	165208	3/30

Specifications | Miniature Circuit Breakers PL7

Description

- High selectivity between MCB and back-up fuse due to low let-through energy
- Compatible with standard busbar
- Twin-purpose terminal (lift/open-mouthed) above and below
- Busbar positioning optionally above or below
- Meets the requirements of insulation co-ordination, distance between contacts ≥ 4 mm, for secure isolation
- Suitable for applications up to 48 V DC (use PL7-DC for higher DC voltages)

Accessories:

Auxiliary switch for subsequent installation	ZP-IHK	286052
	ZP-WHK	286053
Tripping signal switch for subsequent installation	ZP-NHK	248437
Remote control and automatic switching device	Z-FW/LP	248296
Shunt trip release	ZP-ASA/..	248438, 248439
Undervoltage release	Z-USA/..	248288-248291
Additional terminal 35 mm ²	BB-UL-TEPA/35	169823
Switching interlock	Z-IS/SPE-1TE	274418

Technical Data

PL7

Electrical

Design according to		IEC/EN 60898-1
Current test marks as printed onto the device		
Rated voltage	U_n	AC: 230/400 V DC: 48 V (per pole, max. 2 poles)
Rated frequency		50/60 Hz
Rated breaking capacity according to IEC/EN 60898-1	I_{cn}	10 kA
Characteristic		B, C, D
Back-up fuse		max. 125 A gL
Selectivity class		3
Rated impulse withstand voltage	U_{imp}	4 kV (1.2/50 μ s)
Endurance		
electrical components		$\geq 10,000$ switching operations
mechanical components		$\geq 20,000$ switching operations
Line voltage connection		at will (above/below)

Mechanical

Frame size		45 mm
Device height		80 mm
Device width		17.5 mm per pole (1MU) 26.3 mm: device 1P+N (1.5MU)
Mounting		quick fastening with 3 lock-in positions on DIN rail IEC/EN 60715
Degree of protection		IP20
Upper and lower terminals		open-mouthed/lift terminals
Terminal protection		finger and hand touch safe, DGVV VS3, EN 50274
Terminal capacity		1-25 mm ²
(1p+N, 1,5TE)		1-25 mm ² / 1-2x10 mm ² (N)
Terminal torque		2-2.4 Nm
(1p+N, 1,5TE)		2-2.4 Nm / 1.2-1.5 Nm (N)
Busbar thickness		0.8 - 2 mm (except N 0.5MU)
Mounting		independent of position
Operation temperature		-25°C to +75°C
Storage- and transport temperature		-40°C up to +75°C

Connection diagrams

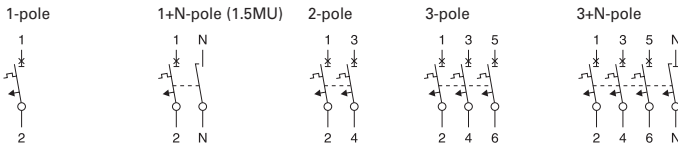

Dimensions (mm)

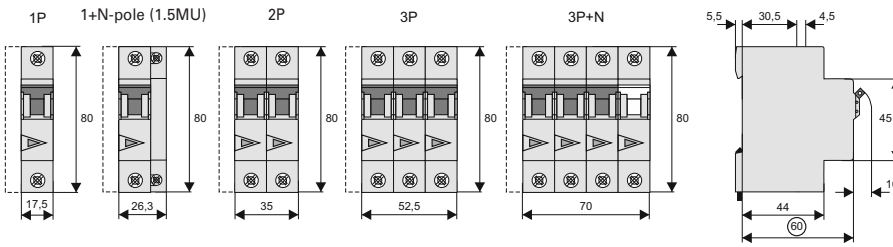

Tripping Characteristics (IEC/EN 60898-1)

Tripping characteristic B

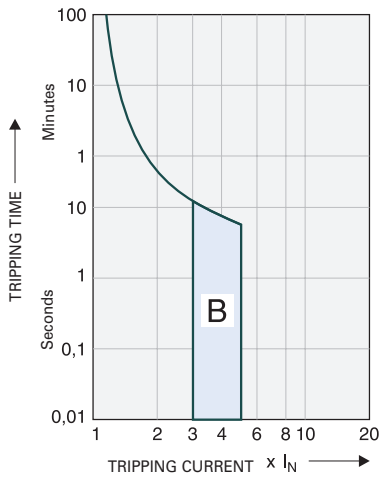

Tripping characteristic C

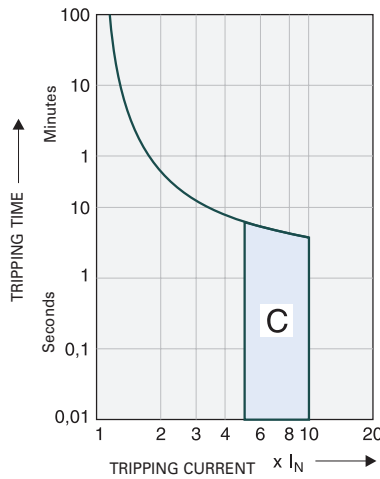

Tripping characteristic D

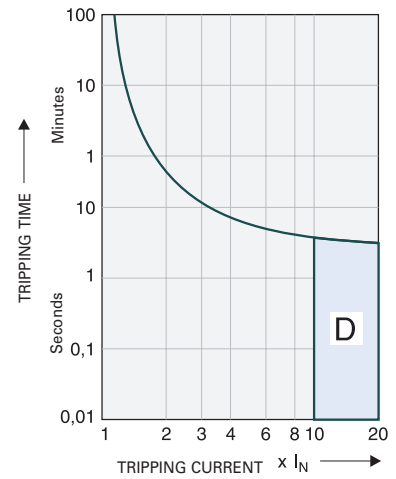

Quick-acting (B), slow (C), very slow (D)

Effect of the Ambient Temperature on Thermal Tripping Behaviour

Adjusted rated current values according to the ambient temperature

I _n [A]	Ambient temperature T [°C]															
	-25	-20	-10	0	10	20	30	35	40	45	50	55	60	65	70	75
0.16	0.20	0.19	0.19	0.18	0.17	0.17	0.16	0.16	0.15	0.15	0.15	0.14	0.14	0.14	0.14	0.13
0.25	0.31	0.30	0.29	0.28	0.27	0.26	0.25	0.25	0.24	0.24	0.23	0.23	0.22	0.22	0.21	0.21
0.5	0.61	0.60	0.58	0.56	0.54	0.52	0.50	0.49	0.48	0.47	0.46	0.45	0.44	0.43	0.42	0.41
0.75	0.92	0.90	0.87	0.84	0.81	0.78	0.75	0.74	0.73	0.71	0.69	0.68	0.66	0.65	0.64	0.62
1	1.2	1.2	1.2	1.1	1.1	1.0	1.0	0.99	0.97	0.95	0.93	0.90	0.89	0.87	0.85	0.83
1.5	1.8	1.8	1.7	1.7	1.6	1.6	1.5	1.5	1.5	1.4	1.4	1.4	1.3	1.3	1.3	1.2
1.6	2.0	1.9	1.9	1.8	1.7	1.7	1.6	1.6	1.5	1.5	1.5	1.4	1.4	1.4	1.4	1.3
2	2.4	2.4	2.3	2.2	2.2	2.1	2.0	2.0	1.9	1.9	1.9	1.8	1.8	1.7	1.7	1.7
2.5	3.1	3.0	2.9	2.8	2.7	2.6	2.5	2.5	2.4	2.4	2.3	2.3	2.2	2.2	2.1	2.1
3	3.7	3.6	3.5	3.4	3.3	3.1	3.0	3.0	2.9	2.8	2.8	2.7	2.7	2.6	2.5	2.5
3.5	4.3	4.2	4.1	3.9	3.8	3.7	3.5	3.4	3.4	3.3	3.2	3.2	3.1	3.0	3.0	2.9
4	4.9	4.8	4.7	4.5	4.3	4.2	4.0	3.9	3.9	3.8	3.7	3.6	3.5	3.5	3.4	3.3
5	6.1	6.0	5.8	5.6	5.4	5.2	5.0	4.9	4.8	4.7	4.6	4.5	4.4	4.3	4.2	4.1
6	7.3	7.2	7.0	6.7	6.5	6.3	6.0	5.9	5.8	5.7	5.6	5.4	5.3	5.2	5.1	5.0
8	9.8	9.6	9.3	9.0	8.7	8.4	8.0	7.9	7.7	7.6	7.4	7.2	7.1	6.9	6.8	6.6
10	12	12	12	11	11	10	10	9.9	9.7	9.5	9.3	9.0	8.9	8.7	8.5	8.3
12	15	14	14	13	13	13	12	12	12	11	11	11	11	10	10	10
13	16	16	15	15	14	14	13	13	13	12	12	12	12	11	11	11
15	18	18	17	17	16	16	15	15	15	14	14	14	13	13	13	12
16	20	19	19	18	17	17	16	16	15	15	15	14	14	14	14	13
20	24	24	23	22	22	21	20	20	19	19	19	18	18	17	17	17
25	31	30	29	28	27	26	25	25	24	24	23	23	22	22	21	21
32	39	38	37	36	35	33	32	32	31	30	30	29	28	28	27	26
40	49	48	47	45	43	42	40	39	39	38	37	36	35	35	34	33
50	61	60	58	56	54	52	50	49	48	47	46	45	44	43	42	41
63	77	76	73	71	68	66	63	62	61	60	58	57	56	55	53	52

Load Capacity of Series Connected Miniature Circuit Breakers

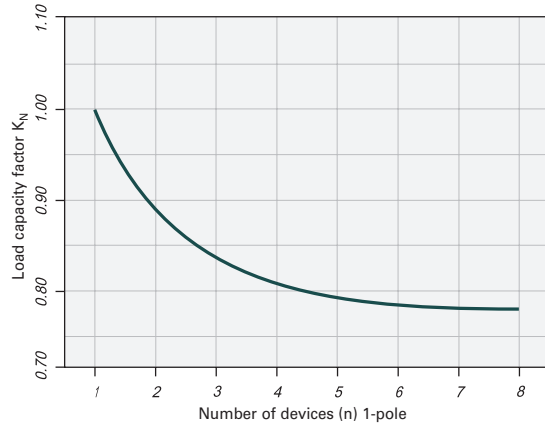

Effect of Power Frequency

Effect of power frequency on the tripping behaviour I_{MA} of the quick release

I _{MA} (f)/I _{MA} (50 Hz) [%]	Power frequency f [Hz]						
	16 ² / ₃	50	60	100	200	300	400
	91	100	101	106	115	134	141

The use of the products in networks with other frequencies than 50/60 Hz is in the customer's responsibility.

Let-through Energy PL7

Let-through Energy PL7, Characteristic B, 1-pole

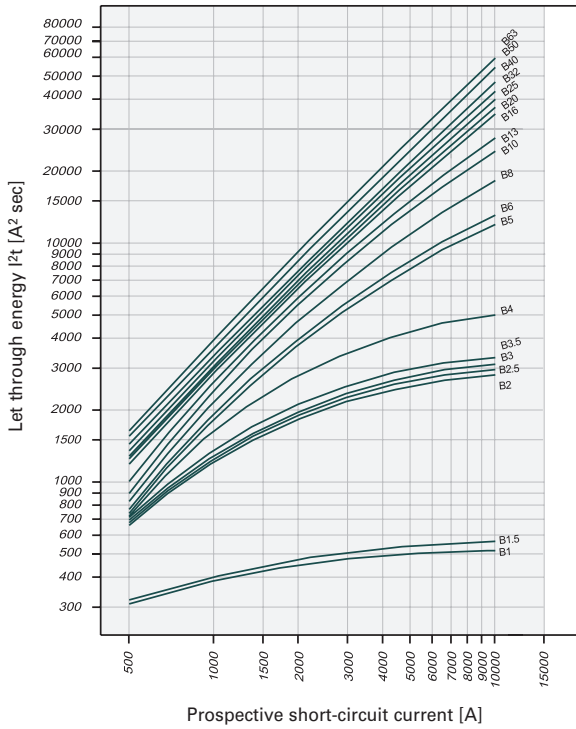

Let-through Energy PL7, Characteristic C, 1-pole

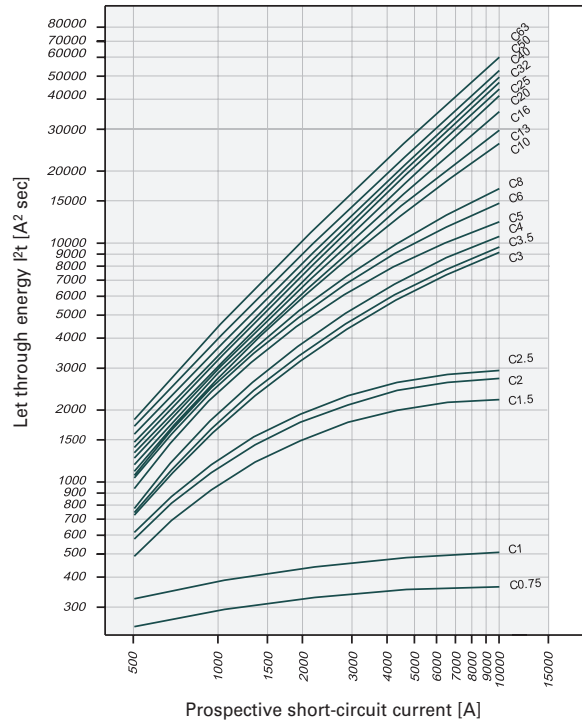

Let-through Energy PL7, Characteristic D, 1-pole

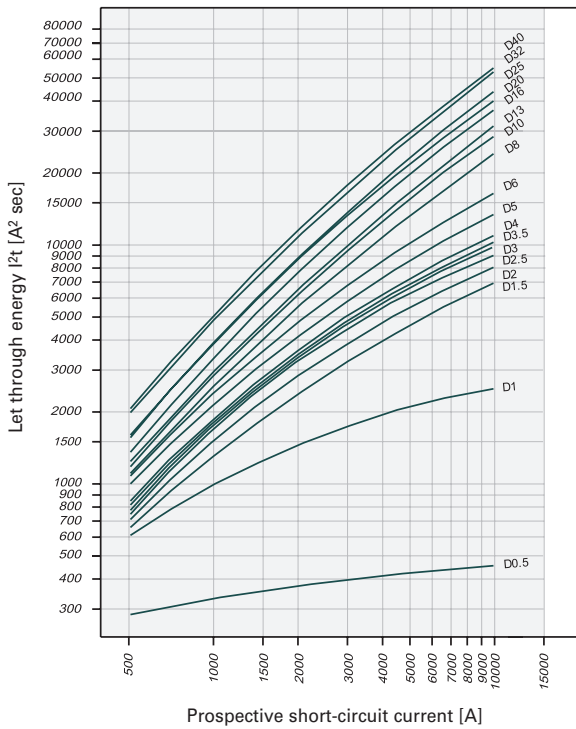

Short-circuit Selectivity PL7 towards DII-DIV fuse link

In case of short-circuit, there is selectivity between the miniature circuit breakers PL7 and the upstream fuses up to the specified values of the selectivity limit current I_s [kA] (i. e. in case of short-circuit currents I_{sc} under I_s only the MCB will trip, in case of short-circuit currents above this value both protective devices will respond).

*) basically in accordance with EN 60898-1 D.5.2.b

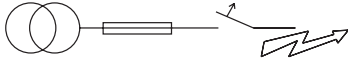

Short-circuit selectivity **Characteristic B** towards fuse link **DII-DIV***)

PL7 I_n [A]	DII-DIV gL/gG								
	10	16	20	25	35	50	63	80	100
2	<0.5 ¹⁾	<0.5 ¹⁾	0.8	1.6	10.0 ²⁾	10.0 ²⁾	10.0 ²⁾	10.0 ²⁾	10.0 ²⁾
4	<0.5 ¹⁾	<0.5 ¹⁾	0.6	1.0	3.6	10.0 ²⁾	10.0 ²⁾	10.0 ²⁾	10.0 ²⁾
5	<0.5 ¹⁾	<0.5 ¹⁾	0.6	0.9	2.0	3.5	8.5	10.0 ²⁾	10.0 ²⁾
6		<0.5 ¹⁾	0.6	0.9	1.8	3.2	7.4	10.0 ²⁾	10.0 ²⁾
8		<0.5 ¹⁾	0.5	0.8	1.6	2.6	5.2	8.3	10.0 ²⁾
10			0.5	0.8	1.4	2.2	3.9	6.0	10.0 ²⁾
13			0.5	0.7	1.3	2.0	3.6	5.4	10.0 ²⁾
16				0.6	1.2	1.9	3.2	4.6	8.4
20					1.2	1.8	3.1	4.4	7.8
25					1.2	1.8	3.0	4.2	7.3
32						1.7	2.8	3.9	6.8
40							2.7	3.8	6.5
50							2.5	3.5	5.7
63									5.3

Short-circuit selectivity **Characteristic C** towards fuse link **DII-DIV***)

PL7 I_n [A]	DII-DIV gL/gG								
	10	16	20	25	35	50	63	80	100
0.75	1.0	10.0 ²⁾	10.0 ²⁾	10.0 ²⁾	10.0 ²⁾	10.0 ²⁾	10.0 ²⁾	10.0 ²⁾	10.0 ²⁾
1.0	<0.5 ¹⁾	1.2	10.0 ²⁾	10.0 ²⁾	10.0 ²⁾	10.0 ²⁾	10.0 ²⁾	10.0 ²⁾	10.0 ²⁾
1.6	<0.5 ¹⁾	<0.5 ¹⁾	1.0	2.2	10.0 ²⁾	10.0 ²⁾	10.0 ²⁾	10.0 ²⁾	10.0 ²⁾
2	<0.5 ¹⁾	<0.5 ¹⁾	0.8	1.6	10.0 ²⁾	10.0 ²⁾	10.0 ²⁾	10.0 ²⁾	10.0 ²⁾
4	<0.5 ¹⁾	<0.5 ¹⁾	0.6	0.8	1.8	3.6	9.7	10.0 ²⁾	10.0 ²⁾
5	<0.5 ¹⁾	<0.5 ¹⁾	0.6	0.7	1.5	2.7	7.3	10.0 ²⁾	10.0 ²⁾
6		<0.5 ¹⁾	0.5	0.6	1.4	2.4	5.5	10.0 ²⁾	10.0 ²⁾
8		<0.5 ¹⁾	<0.5 ¹⁾	0.6	1.3	2.2	4.7	8.7	10.0 ²⁾
10			<0.5 ¹⁾	0.6	1.3	2.0	3.6	5.4	10.0 ²⁾
13					1.3	1.9	3.3	5.0	9.4
16					1.2	1.8	3.2	4.4	8.0
20					1.2	1.8	3.1	4.1	7.0
25						1.7	2.8	3.8	6.5
32							2.7	3.7	6.2
40								3.5	5.9
50									5.5
63									

Short-circuit selectivity **Characteristic D** towards fuse link **DII-DIV***)

PL7 I_n [A]	DII-DIV gL/gG								
	10	16	20	25	35	50	63	80	100
2	<0.5 ¹⁾	<0.5 ¹⁾	0.6	1.0	2.8	5.8	10.0 ²⁾	10.0 ²⁾	10.0 ²⁾
4		<0.5 ¹⁾	0.6	0.9	2.0	3.8	9.5	10.0 ²⁾	10.0 ²⁾
5		<0.5 ¹⁾	0.5	0.7	1.7	3.1	7.0	10.0 ²⁾	10.0 ²⁾
6			0.5	0.7	1.5	2.6	5.3	9.1	10.0 ²⁾
8			<0.5 ¹⁾	0.7	1.4	2.2	3.9	6.0	10.0 ²⁾
10				0.7	1.2	1.9	3.4	5.0	9.5
13					1.2	1.8	3.2	4.6	8.6
16						1.6	2.7	4.0	7.4
20						1.5	2.5	3.5	6.7
25							2.4	3.4	6.2
32								2.8	5.0
40									4.8

¹⁾ Selectivity limit current I_s under 0.5 kA

²⁾ Selectivity limit current I_s = rated breaking capacity I_{cn} of the MCB

Darker areas: no selectivity

Short-circuit Selectivity PL7 towards D01-D03 fuse link

In case of short-circuit, there is selectivity between the miniature circuit breakers PL7 and the upstream fuses up to the specified values of the selectivity limit current I_s [kA] (i. e. in case of short-circuit currents I_{sc} under I_s only the MCB will trip, in case of short-circuit currents above this value both protective devices will respond).

*) basically in accordance with EN 60898-1 D.5.2.b

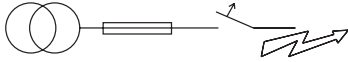

Short-circuit selectivity **Characteristic B** towards fuse link **D01-D03***)

PL7 I_n [A]	DII-DIV gL/gG								
	10	16	20	25	35	50	63	80	100
2	<0.5 ¹⁾	<0.5 ¹⁾	0.6	1.0	10.0 ²⁾	10.0 ²⁾	10.0 ²⁾	10.0 ²⁾	10.0 ²⁾
4	<0.5 ¹⁾	<0.5 ¹⁾	0.5	0.9	2.5	10.0 ²⁾	10.0 ²⁾	10.0 ²⁾	10.0 ²⁾
5		<0.5 ¹⁾	0.5	0.8	1.7	4.0	7.0	10.0 ²⁾	10.0 ²⁾
6		<0.5 ¹⁾	0.5	0.8	1.6	3.6	6.0	10.0 ²⁾	10.0 ²⁾
8			0.5	0.8	1.4	2.8	4.3	8.2	10.0 ²⁾
10			0.5	0.7	1.3	2.4	3.4	6.0	10.0 ²⁾
13			<0.5 ¹⁾	0.7	1.2	2.3	3.2	5.3	10.0 ²⁾
16				0.6	1.1	2.2	2.9	4.6	10.0
20					1.1	2.1	2.8	4.4	9.3
25					1.1	2.0	2.7	4.2	8.7
32						2.0	2.6	4.0	8.0
40							2.5	3.8	7.5
50							2.3	3.4	6.7
63									6.2

Short-circuit selectivity **Characteristic C** towards fuse link **D01-D03***)

PL7 I_n [A]	DII-DIV gL/gG								
	10	16	20	25	35	50	63	80	100
0.75	<0.5 ¹⁾	10.0 ²⁾	10.0 ²⁾	10.0 ²⁾	10.0 ²⁾	10.0 ²⁾	10.0 ²⁾	10.0 ²⁾	10.0 ²⁾
1.0	<0.5 ¹⁾	10.0 ²⁾	10.0 ²⁾	10.0 ²⁾	10.0 ²⁾	10.0 ²⁾	10.0 ²⁾	10.0 ²⁾	10.0 ²⁾
1.6	<0.5 ¹⁾	0.5	0.6	0.9	10.0 ²⁾	10.0 ²⁾	10.0 ²⁾	10.0 ²⁾	10.0 ²⁾
2	<0.5 ¹⁾	<0.5 ¹⁾	0.5	0.7	10.0 ²⁾	10.0 ²⁾	10.0 ²⁾	10.0 ²⁾	10.0 ²⁾
4	<0.5 ¹⁾	<0.5 ¹⁾	<0.5 ¹⁾	0.6	1.6	4.0	7.6	10.0 ²⁾	10.0 ²⁾
5		<0.5 ¹⁾	<0.5 ¹⁾	0.5	1.3	3.1	5.7	10.0 ²⁾	10.0 ²⁾
6		<0.5 ¹⁾	<0.5 ¹⁾	<0.5 ¹⁾	1.2	2.7	4.5	10.0 ²⁾	10.0 ²⁾
8		<0.5 ¹⁾	<0.5 ¹⁾	<0.5 ¹⁾	1.2	2.5	4.0	8.6	10.0 ²⁾
10			<0.5 ¹⁾	<0.5 ¹⁾	1.2	2.3	3.1	5.4	10.0 ²⁾
13					1.1	2.2	3.0	4.9	10.0 ²⁾
16					1.1	2.1	2.8	4.4	9.5
20					1.0	2.0	2.6	4.0	8.3
25						1.9	2.5	3.8	7.8
32							2.5	3.7	7.3
40								3.5	7.0
50									6.5
63									

Short-circuit selectivity **Characteristic D** towards fuse link **D01-D03***)

PL7 I_n [A]	DII-DIV gL/gG								
	10	16	20	25	35	50	63	80	100
4		<0.5 ¹⁾	0.5	0.7	1.7	4.6	7.7	10.0 ²⁾	10.0 ²⁾
5		<0.5 ¹⁾	<0.5 ¹⁾	0.6	1.5	3.5	5.8	10.0 ²⁾	10.0 ²⁾
6			<0.5 ¹⁾	0.5	1.3	2.9	4.5	9.0	10.0 ²⁾
8			<0.5 ¹⁾	0.5	1.2	2.4	3.5	6.0	10.0 ²⁾
10				0.5	1.1	2.2	3.0	5.0	10.0 ²⁾
13					1.1	2.1	2.9	4.6	10.0 ²⁾
16						1.9	2.6	3.9	9.0
20						1.7	2.3	3.5	8.0
25							2.2	3.4	7.5
32								2.9	6.0
40									5.7

¹⁾ Selectivity limit current I_s under 0.5 kA

²⁾ Selectivity limit current I_s = rated breaking capacity I_{cn} of the MCB

Darker areas: no selectivity

Short-circuit Selectivity PL7 towards NH-00 fuse link

In case of short-circuit, there is selectivity between the miniature circuit breakers PL7 and the upstream fuses up to the specified values of the selectivity limit current I_s [kA] (i. e. in case of short-circuit currents I_{ks} under I_s only the MCB will trip, in case of short-circuit currents above this value both protective devices will respond).

*) basically in accordance with EN 60898-1 D.5.2.b

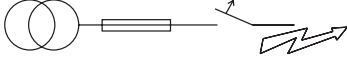

Short-circuit selectivity **Characteristic B** towards fuse link **NH-00***)

PL7	NH-00 gL/gG												
I_n [A]	16	20	25	32	35	40	50	63	80	100	125	160	
2	<0.5 ¹⁾	0.5	1.0	2.5	10.0 ²⁾	10.0 ²⁾	10.0 ²⁾	10.0 ²⁾	10.0 ²⁾	10.0 ²⁾	10.0 ²⁾	10.0 ²⁾	
4	<0.5 ¹⁾	<0.5 ¹⁾	0.8	1.3	2.3	4.3	10.0 ²⁾	10.0 ²⁾	10.0 ²⁾	10.0 ²⁾	10.0 ²⁾	10.0 ²⁾	
5	<0.5 ¹⁾	<0.5 ¹⁾	0.7	1.1	1.6	2.2	3.6	4.8	8.9	10.0 ²⁾	10.0 ²⁾	10.0 ²⁾	
6	<0.5 ¹⁾	<0.5 ¹⁾	0.7	1.1	1.5	2.0	3.3	4.3	7.6	10.0 ²⁾	10.0 ²⁾	10.0 ²⁾	
8	<0.5 ¹⁾	<0.5 ¹⁾	0.6	1.0	1.3	1.7	2.6	3.3	5.2	10.0 ²⁾	10.0 ²⁾	10.0 ²⁾	
10	<0.5 ¹⁾	0.6	0.9	1.2	1.5	2.2	2.7	4.0	9.0	10.0 ²⁾	10.0 ²⁾	10.0 ²⁾	
13	<0.5 ¹⁾	0.6	0.8	1.1	1.4	2.1	2.6	3.8	7.9	10.0 ²⁾	10.0 ²⁾	10.0 ²⁾	
16		0.5	0.7	1.0	1.3	1.9	2.4	3.4	6.4	9.3	10.0 ²⁾		
20			0.7	1.0	1.3	1.9	2.4	3.3	6.0	8.7	10.0 ²⁾		
25				0.7	1.0	1.3	1.8	2.3	3.2	5.7	8.0	10.0 ²⁾	
32					0.9	1.2	1.7	2.2	3.1	5.4	7.6	10.0 ²⁾	
40								2.1	3.0	5.1	7.2	10.0 ²⁾	
50									1.9	2.8	4.7	6.6	9.5
63										4.4	6.3	8.6	

Short-circuit selectivity **Characteristic C** towards fuse link **NH-00***)

PL7	NH-00 gL/gG														
I_n [A]	16	20	25	32	35	40	50	63	80	100	125	160			
0.75	10.0 ²⁾	10.0 ²⁾	10.0 ²⁾	10.0 ²⁾	10.0 ²⁾	10.0 ²⁾	10.0 ²⁾	10.0 ²⁾	10.0 ²⁾	10.0 ²⁾	10.0 ²⁾	10.0 ²⁾			
1.0	0.9	10.0 ²⁾	10.0 ²⁾	10.0 ²⁾	10.0 ²⁾	10.0 ²⁾	10.0 ²⁾	10.0 ²⁾	10.0 ²⁾	10.0 ²⁾	10.0 ²⁾	10.0 ²⁾			
1.6	<0.5 ¹⁾	0.6	1.3	4.2	10.0 ²⁾	10.0 ²⁾	10.0 ²⁾	10.0 ²⁾	10.0 ²⁾	10.0 ²⁾	10.0 ²⁾	10.0 ²⁾			
2	<0.5 ¹⁾	0.6	1.0	2.5	10.0 ²⁾	10.0 ²⁾	10.0 ²⁾	10.0 ²⁾	10.0 ²⁾	10.0 ²⁾	10.0 ²⁾	10.0 ²⁾			
4	<0.5 ¹⁾	<0.5 ¹⁾	0.7	1.0	1.5	2.1	3.6	5.0	10.0	10.0 ²⁾	10.0 ²⁾	10.0 ²⁾			
5	<0.5 ¹⁾	<0.5 ¹⁾	0.6	0.8	1.2	1.7	2.8	3.8	8.7	10.0 ²⁾	10.0 ²⁾	10.0 ²⁾			
6	<0.5 ¹⁾	<0.5 ¹⁾	0.5	0.8	1.2	1.5	2.5	3.3	5.7	10.0 ²⁾	10.0 ²⁾	10.0 ²⁾			
8	<0.5 ¹⁾	<0.5 ¹⁾	0.5	0.8	1.1	1.5	2.3	2.9	4.9	10.0 ²⁾	10.0 ²⁾	10.0 ²⁾			
10			0.5	0.7	1.0	1.4	2.0	2.5	3.8	8.0	10.0 ²⁾	10.0 ²⁾			
13						1.0	1.3	1.9	2.4	3.6	7.0	10.0 ²⁾			
16							1.0	1.3	1.8	2.3	3.3	6.0	8.8	10.0 ²⁾	
20								1.0	1.2	1.7	2.2	3.2	5.5	7.7	10.0 ²⁾
25									1.6	2.1	3.0	5.2	7.3	10.0 ²⁾	
32										2.1	2.9	5.0	7.0	10.0 ²⁾	
40											2.8	4.8	6.7	10.0	
50												4.5	6.3	9.5	
63													5.9	8.4	

Short-circuit selectivity **Characteristic D** towards fuse link **NH-00***)

PL7	NH-00 gL/gG												
I_n [A]	16	20	25	32	35	40	50	63	80	100	125	160	
4	<0.5 ¹⁾	<0.5 ¹⁾	0.7	1.0	1.6	2.2	3.8	5.2	10.0	10.0 ²⁾	10.0 ²⁾	10.0 ²⁾	
5		<0.5 ¹⁾	0.6	0.9	1.4	1.9	3.2	4.1	7.1	10.0 ²⁾	10.0 ²⁾	10.0 ²⁾	
6		<0.5 ¹⁾	0.5	0.8	1.2	1.6	2.6	3.3	5.5	10.0 ²⁾	10.0 ²⁾	10.0 ²⁾	
8			0.5	0.8	1.1	1.5	2.2	2.7	4.1	8.7	10.0 ²⁾	10.0 ²⁾	
10			0.5	0.7	1.0	1.3	1.9	2.5	3.6	7.2	10.0 ²⁾	10.0 ²⁾	
13					1.0	1.3	1.9	2.3	3.4	6.5	9.5	10.0 ²⁾	
16						1.1	1.6	2.0	3.0	5.5	8.0	10.0 ²⁾	
20							1.4	1.8	2.8	5.0	7.5	10.0 ²⁾	
25								1.8	2.7	4.8	7.0	10.0 ²⁾	
32									2.4	4.1	6.2	9.3	
40										4.0	6.0	9.0	

¹⁾ Selectivity limit current I_s under 0.5 kA

²⁾ Selectivity limit current I_s = rated breaking capacity I_{cn} of the MCB

Darker areas: no selectivity

SG62211

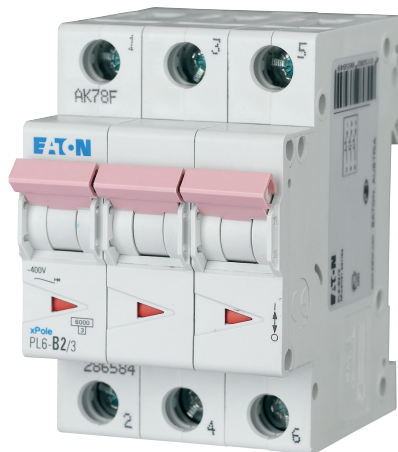

Description

- High-quality miniature circuit breakers for commercial and residential applications
- Contact position indicator red - green
- Guide for secure terminal connection
- 3-position DIN rail clip, permits removal from existing busbar system
- Comprehensive range of accessories can be mounted subsequently
- Rated currents up to 63 A
- Tripping characteristics B, C, D
- Rated breaking capacity 6 kA according to IEC/EN 60898-1

1.5

Miniature Circuit Breakers (MCBs)

xPole

Miniature Circuit Breakers PL6

SG45411



Rated current I_n (A)	Type Designation	Article No.	Units per package
----------------------------	---------------------	-------------	----------------------

6 kA, Characteristic B

1-pole

1	PL6-B1/1	164740	12/120
2	PL6-B2/1	286516	12/120
4	PL6-B4/1	286517	12/120
6	PL6-B6/1	286518	12/120
10	PL6-B10/1	286519	12/120
13	PL6-B13/1	286520	12/120
16	PL6-B16/1	286521	12/120
20	PL6-B20/1	286522	12/120
25	PL6-B25/1	286523	12/120
32	PL6-B32/1	286524	12/120
40	PL6-B40/1	286525	12/120
50	PL6-B50/1	286526	12/120
63	PL6-B63/1	286527	12/120

SG51411



1+N-pole

1	PL6-B1/1N	164903	8/80
2	PL6-B2/1N	164907	8/80
4	PL6-B4/1N	164913	8/80
6	PL6-B6/1N	106025	8/80
10	PL6-B10/1N	106026	8/80
13	PL6-B13/1N	106027	8/80
16	PL6-B16/1N	106028	8/80
20	PL6-B20/1N	164908	8/80
25	PL6-B25/1N	164909	8/80
32	PL6-B32/1N	164912	8/80

SG51511



Rated current I_n (A)	Type Designation	Article No.	Units per package
2-pole			
1	PL6-B1/2	164803	6/60
2	PL6-B2/2	286550	6/60
4	PL6-B4/2	286551	6/60
6	PL6-B6/2	286552	6/60
10	PL6-B10/2	286553	6/60
13	PL6-B13/2	286554	6/60
16	PL6-B16/2	286555	6/60
20	PL6-B20/2	286556	6/60
25	PL6-B25/2	286557	6/60
32	PL6-B32/2	286558	6/60
40	PL6-B40/2	286559	6/60
50	PL6-B50/2	286560	6/60
63	PL6-B63/2	286561	6/60

SG62211



Rated current I_n (A)	Type Designation	Article No.	Units per package
3-pole			
1	PL6-B1/3	164868	4/40
2	PL6-B2/3	286584	4/40
4	PL6-B4/3	286585	4/40
6	PL6-B6/3	286586	4/40
10	PL6-B10/3	286587	4/40
13	PL6-B13/3	286588	4/40
16	PL6-B16/3	286589	4/40
20	PL6-B20/3	286590	4/40
25	PL6-B25/3	286591	4/40
32	PL6-B32/3	286592	4/40
40	PL6-B40/3	286593	4/40
50	PL6-B50/3	286594	4/40
63	PL6-B63/3	286595	4/40

1.5

Miniature Circuit Breakers (MCBs)

xPole

Miniature Circuit Breakers PL6

SG64711



Rated current I_n (A)	Type Designation	Article No.	Units per package
3+N-pole			
1	PL6-B1/3N	165002	3/30
2	PL6-B2/3N	165007	3/30
4	PL6-B4/3N	165010	3/30
6	PL6-B6/3N	106035	3/30
10	PL6-B10/3N	106036	3/30
13	PL6-B13/3N	165004	3/30
16	PL6-B16/3N	106037	3/30
20	PL6-B20/3N	106038	3/30
25	PL6-B25/3N	106039	3/30
32	PL6-B32/3N	106040	3/30
40	PL6-B40/3N	106041	3/30
50	PL6-B50/3N	106903	3/30
63	PL6-B63/3N	106904	3/30

SG26612



Rated current I_n (A)	Type Designation	Article No.	Units per package
4-pole			
1	PL6-B1/4	166489	3/30
2	PL6-B2/4	166496	3/30
4	PL6-B4/4	166501	3/30
6	PL6-B6/4	166505	3/30
10	PL6-B10/4	166490	3/30
13	PL6-B13/4	166492	3/30
16	PL6-B16/4	166494	3/30
20	PL6-B20/4	166497	3/30
25	PL6-B25/4	166498	3/30
32	PL6-B32/4	166500	3/30
40	PL6-B40/4	166502	3/30
50	PL6-B50/4	166504	3/30
63	PL6-B63/4	166506	3/30

SG45411



Rated current
 I_n (A)

Type
Designation

Article No.

Units per
package

6 kA, Characteristic C

1-pole

1	PL6-C1/1	164754	12/120
2	PL6-C2/1	286528	12/120
4	PL6-C4/1	286529	12/120
6	PL6-C6/1	286530	12/120
10	PL6-C10/1	286531	12/120
13	PL6-C13/1	286532	12/120
16	PL6-C16/1	286533	12/120
20	PL6-C20/1	286534	12/120
25	PL6-C25/1	286535	12/120
32	PL6-C32/1	286536	12/120
40	PL6-C40/1	286537	12/120
50	PL6-C50/1	286538	12/120
63	PL6-C63/1	286539	12/120

SG51411



1+N-pole

1	PL6-C1/1N	164922	8/80
2	PL6-C2/1N	106029	8/80
4	PL6-C4/1N	106030	8/80
6	PL6-C6/1N	106031	8/80
10	PL6-C10/1N	106032	8/80
13	PL6-C13/1N	106033	8/80
16	PL6-C16/1N	106034	8/80
20	PL6-C20/1N	164926	8/80
25	PL6-C25/1N	164927	8/80
32	PL6-C32/1N	164930	8/80

1.5

Miniature Circuit Breakers (MCBs)

xPole

Miniature Circuit Breakers PL6

SG51511



Rated current I_n (A)	Type Designation	Article No.	Units per package
2-pole			
1	PL6-C1/2	164817	6/60
2	PL6-C2/2	286562	6/60
4	PL6-C4/2	286563	6/60
6	PL6-C6/2	286564	6/60
10	PL6-C10/2	286565	6/60
13	PL6-C13/2	286566	6/60
16	PL6-C16/2	286567	6/60
20	PL6-C20/2	286568	6/60
25	PL6-C25/2	286569	6/60
32	PL6-C32/2	286570	6/60
40	PL6-C40/2	286571	6/60
50	PL6-C50/2	286572	6/60
63	PL6-C63/2	286573	6/60

SG62211



Rated current I_n (A)	Type Designation	Article No.	Units per package
3-pole			
1	PL6-C1/3	164882	4/40
2	PL6-C2/3	286596	4/40
4	PL6-C4/3	286597	4/40
6	PL6-C6/3	286598	4/40
10	PL6-C10/3	286599	4/40
13	PL6-C13/3	286600	4/40
16	PL6-C16/3	286601	4/40
20	PL6-C20/3	286602	4/40
25	PL6-C25/3	286603	4/40
32	PL6-C32/3	286604	4/40
40	PL6-C40/3	286605	4/40
50	PL6-C50/3	286606	4/40
63	PL6-C63/3	286607	4/40

SG64711



Rated current
 I_n (A)

Type
Designation

Article No.

Units per
package

3+N-pole

Rated current I_n (A)	Type Designation	Article No.	Units per package
1	PL6-C1/3N	165019	3/30
2	PL6-C2/3N	106905	3/30
4	PL6-C4/3N	106906	3/30
6	PL6-C6/3N	106907	3/30
10	PL6-C10/3N	106908	3/30
13	PL6-C13/3N	106909	3/30
16	PL6-C16/3N	106910	3/30
20	PL6-C20/3N	106911	3/30
25	PL6-C25/3N	106912	3/30
32	PL6-C32/3N	106913	3/30
40	PL6-C40/3N	106914	3/30
50	PL6-C50/3N	106915	3/30
63	PL6-C63/3N	106916	3/30

SG26612



4-pole

Rated current I_n (A)	Type Designation	Article No.	Units per package
1	PL6-C1/4	166514	3/30
2	PL6-C2/4	166521	3/30
4	PL6-C4/4	166527	3/30
6	PL6-C6/4	166531	3/30
10	PL6-C10/4	166515	3/30
13	PL6-C13/4	166517	3/30
16	PL6-C16/4	166519	3/30
20	PL6-C20/4	166522	3/30
25	PL6-C25/4	166523	3/30
32	PL6-C32/4	166526	3/30
40	PL6-C40/4	166528	3/30
50	PL6-C50/4	166530	3/30
63	PL6-C63/4	166532	3/30

Rated current I_n (A)	Type Designation	Article No.	Units per package
----------------------------	---------------------	-------------	----------------------

6 kA, Characteristic D

SG45411



1-pole

1	PL6-D1/1	164765	12/120
2	PL6-D2/1	286540	12/120
4	PL6-D4/1	286541	12/120
6	PL6-D6/1	286542	12/120
10	PL6-D10/1	286543	12/120
13	PL6-D13/1	286544	12/120
16	PL6-D16/1	286545	12/120
20	PL6-D20/1	286546	12/120
25	PL6-D25/1	286547	12/120
32	PL6-D32/1	286548	12/120
40	PL6-D40/1	286549	12/120

SG51411



1+N-pole

1	PL6-D1/1N	164936	8/80
2	PL6-D2/1N	164943	8/80
4	PL6-D4/1N	164948	8/80
6	PL6-D6/1N	164950	8/80
10	PL6-D10/1N	164937	8/80
13	PL6-D13/1N	164939	8/80
16	PL6-D16/1N	164941	8/80
20	PL6-D20/1N	164944	8/80
25	PL6-D25/1N	164945	8/80

SG51511



Rated current
 I_n (A)

Type
Designation

Article No.

Units per
package

2-pole

1	PL6-D1/2	164828	6/60
2	PL6-D2/2	286574	6/60
4	PL6-D4/2	286575	6/60
6	PL6-D6/2	286576	6/60
10	PL6-D10/2	286577	6/60
13	PL6-D13/2	286578	6/60
16	PL6-D16/2	286579	6/60
20	PL6-D20/2	286580	6/60
25	PL6-D25/2	286581	6/60
32	PL6-D32/2	286582	6/60
40	PL6-D40/2	286583	6/60

SG62211



3-pole

1	PL6-D1/3	164893	4/40
2	PL6-D2/3	286608	4/40
4	PL6-D4/3	286609	4/40
6	PL6-D6/3	286610	4/40
10	PL6-D10/3	286611	4/40
13	PL6-D13/3	286612	4/40
16	PL6-D16/3	286613	4/40
20	PL6-D20/3	286614	4/40
25	PL6-D25/3	286615	4/40
32	PL6-D32/3	286616	4/40
40	PL6-D40/3	286617	4/40

1.5

Miniature Circuit Breakers (MCBs)

xPole

Miniature Circuit Breakers PL6

SG64711



Rated current I_n (A)	Type Designation	Article No.	Units per package
3+N-pole			
1	PL6-D1/3N	165030	3/30
2	PL6-D2/3N	165037	3/30
4	PL6-D4/3N	165043	3/30
6	PL6-D6/3N	165046	3/30
10	PL6-D10/3N	165031	3/30
13	PL6-D13/3N	165033	3/30
16	PL6-D16/3N	165035	3/30
20	PL6-D20/3N	165038	3/30
25	PL6-D25/3N	165039	3/30
32	PL6-D32/3N	165042	3/30
40	PL6-D40/3N	165044	3/30

SG26612



Rated current I_n (A)	Type Designation	Article No.	Units per package
4-pole			
1	PL6-D1/4	166537	3/30
2	PL6-D2/4	166544	3/30
4	PL6-D4/4	166550	3/30
6	PL6-D6/4	166553	3/30
10	PL6-D10/4	166538	3/30
13	PL6-D13/4	166540	3/30
16	PL6-D16/4	166542	3/30
20	PL6-D20/4	166545	3/30
25	PL6-D25/4	166546	3/30
32	PL6-D32/4	166549	3/30
40	PL6-D40/4	166551	3/30

Specifications | Miniature Circuit Breakers PL6

Description

- High selectivity between MCB and back-up fuse due to low let-through energy
- Compatible with standard busbar
- Twin-purpose terminal (lift/open-mouthed) above and below
- Busbar positioning optionally above or below
- Meets the requirements of insulation co-ordination, distance between contacts ≥ 4 mm, for secure isolation
- Suitable for applications up to 48 V DC

Accessories:

Auxiliary switch for subsequent installation	ZP-IHK	286052
	ZP-WHK	286053
Tripping signal switch for subsequent installation	ZP-NHK	248437
Remote control and automatic switching device	Z-FW/LP	248296
Shunt trip release	ZP-ASA/..	248438, 248439
Undervoltage release	Z-USA/..	248288-248291
Additional terminal 35 mm ²	BB-UL-TEPA/35	169823
Switching interlock	Z-IS/SPE-1TE	274418

Technical Data

PL6

Electrical

Design according to		IEC/EN 60898-1
Current test marks as printed onto the device		
Rated voltage	U_n	AC: 230/400 V DC: 48 V (per pole, max. 2 poles)
Rated frequency		50/60 Hz
Rated breaking capacity according to IEC/EN 60898-1	I_{cn}	6 kA
Characteristic		B, C, D
Back-up fuse		max. 100 A gL
Selectivity class		3
Rated impulse withstand voltage	U_{imp}	4 kV (1.2/50 μ s)
Endurance		
electrical components		$\geq 10,000$ switching operations
mechanical components		$\geq 20,000$ switching operations
Line voltage connection		at will (above/below)
Minimal voltage		12 V AC/DC

Mechanical

Frame size		45 mm
Device height		80 mm
Device width		17.5 mm per pole (1MU)
Mounting		quick fastening with 3 lock-in positions on DIN rail IEC/EN 60715
Degree of protection		IP20
Upper and lower terminals		open-mouthed/lift terminals
Terminal protection		finger and hand touch safe, DGUV VS3, EN 50274
Terminal capacity		1-25 mm ²
Terminal torque		2-2.4 Nm
Busbar thickness		0.8 - 2 mm
Mounting		independent of position
Operation temperature		-25°C to +75°C
Storage- and transport temperature		-40°C up to +75°C

Connection diagrams

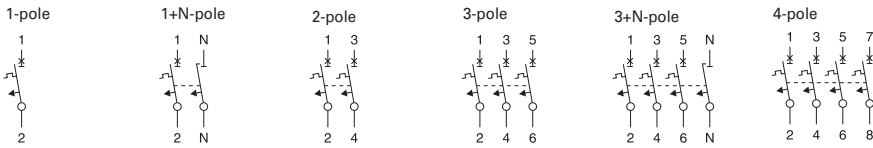

Dimensions (mm)

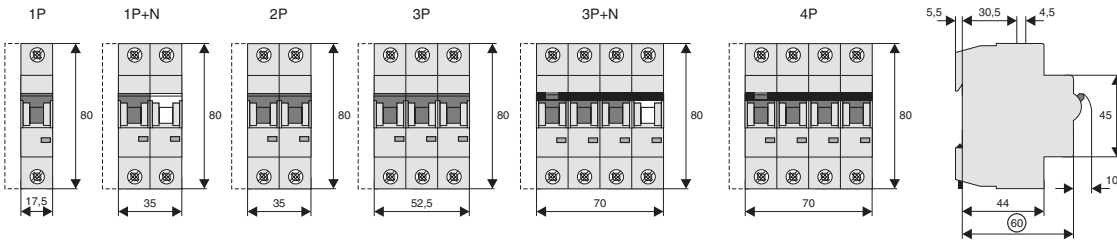

Tripping Characteristics (IEC/EN 60898-1)

Tripping characteristic B

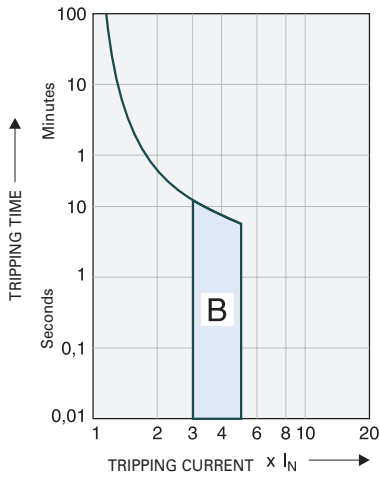

Tripping characteristic C

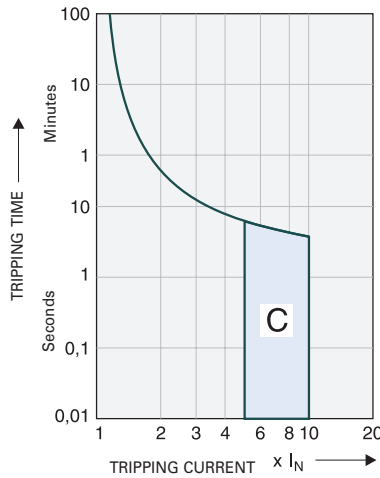

Tripping characteristic D

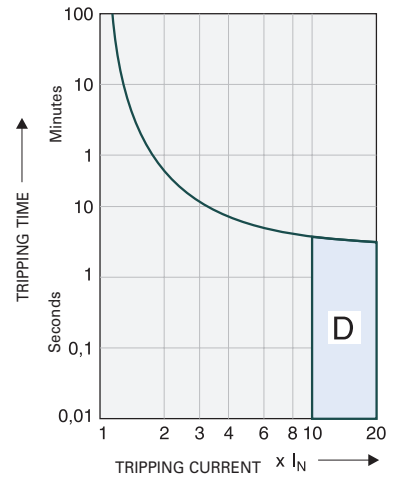

Quick-acting (B), slow (C), very slow (D)

Effect of the Ambient Temperature on Thermal Tripping Behaviour

Adjusted rated current values according to the ambient temperature

I _n [A]	Ambient temperature T [°C]															
	-25	-20	-10	0	10	20	30	35	40	45	50	55	60	65	70	75
0.16	0.20	0.19	0.19	0.18	0.17	0.17	0.16	0.16	0.15	0.15	0.15	0.14	0.14	0.14	0.14	0.13
0.25	0.31	0.30	0.29	0.28	0.27	0.26	0.25	0.25	0.24	0.24	0.23	0.23	0.22	0.22	0.21	0.21
0.5	0.61	0.60	0.58	0.56	0.54	0.52	0.50	0.49	0.48	0.47	0.46	0.45	0.44	0.43	0.42	0.41
0.75	0.92	0.90	0.87	0.84	0.81	0.78	0.75	0.74	0.73	0.71	0.69	0.68	0.66	0.65	0.64	0.62
1	1.2	1.2	1.2	1.1	1.1	1.0	1.0	0.99	0.97	0.95	0.93	0.90	0.89	0.87	0.85	0.83
1.5	1.8	1.8	1.7	1.7	1.6	1.6	1.5	1.5	1.5	1.4	1.4	1.4	1.3	1.3	1.3	1.2
1.6	2.0	1.9	1.9	1.8	1.7	1.7	1.6	1.6	1.5	1.5	1.5	1.4	1.4	1.4	1.4	1.3
2	2.4	2.4	2.3	2.2	2.2	2.1	2.0	2.0	1.9	1.9	1.9	1.8	1.8	1.7	1.7	1.7
2.5	3.1	3.0	2.9	2.8	2.7	2.6	2.5	2.5	2.4	2.4	2.3	2.3	2.2	2.2	2.1	2.1
3	3.7	3.6	3.5	3.4	3.3	3.1	3.0	3.0	2.9	2.8	2.8	2.7	2.7	2.6	2.5	2.5
3.5	4.3	4.2	4.1	3.9	3.8	3.7	3.5	3.4	3.4	3.3	3.2	3.2	3.1	3.0	3.0	2.9
4	4.9	4.8	4.7	4.5	4.3	4.2	4.0	3.9	3.9	3.8	3.7	3.6	3.5	3.5	3.4	3.3
5	6.1	6.0	5.8	5.6	5.4	5.2	5.0	4.9	4.8	4.7	4.6	4.5	4.4	4.3	4.2	4.1
6	7.3	7.2	7.0	6.7	6.5	6.3	6.0	5.9	5.8	5.7	5.6	5.4	5.3	5.2	5.1	5.0
8	9.8	9.6	9.3	9.0	8.7	8.4	8.0	7.9	7.7	7.6	7.4	7.2	7.1	6.9	6.8	6.6
10	12	12	12	11	11	10	10	9.9	9.7	9.5	9.3	9.0	8.9	8.7	8.5	8.3
12	15	14	14	13	13	13	12	12	12	11	11	11	11	10	10	10
13	16	16	15	15	14	14	13	13	13	12	12	12	12	11	11	11
15	18	18	17	17	16	16	15	15	15	14	14	14	13	13	13	12
16	20	19	19	18	17	17	16	16	15	15	15	14	14	14	14	13
20	24	24	23	22	22	21	20	20	19	19	19	18	18	17	17	17
25	31	30	29	28	27	26	25	25	24	24	23	23	22	22	21	21
32	39	38	37	36	35	33	32	32	31	30	30	29	28	28	27	26
40	49	48	47	45	43	42	40	39	39	38	37	36	35	35	34	33
50	61	60	58	56	54	52	50	49	48	47	46	45	44	43	42	41
63	77	76	73	71	68	66	63	62	61	60	58	57	56	55	53	52

Load Capacity of Series Connected Miniature Circuit Breakers

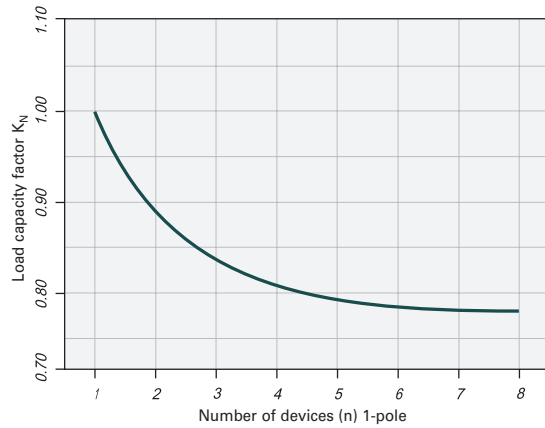

Effect of Power Frequency

Effect of power frequency on the tripping behaviour I_{MA} of the quick release

I _{MA} (f)/I _{MA} (50 Hz) [%]	Power frequency f [Hz]						
	16 ² / ₃	50	60	100	200	300	400
	91	100	101	106	115	134	141

The use of the products in networks with other frequencies than 50/60 Hz is in the customer's responsibility.

Let-through Energy PL6

Let-through Energy PL6, Characteristic B, 1-pole

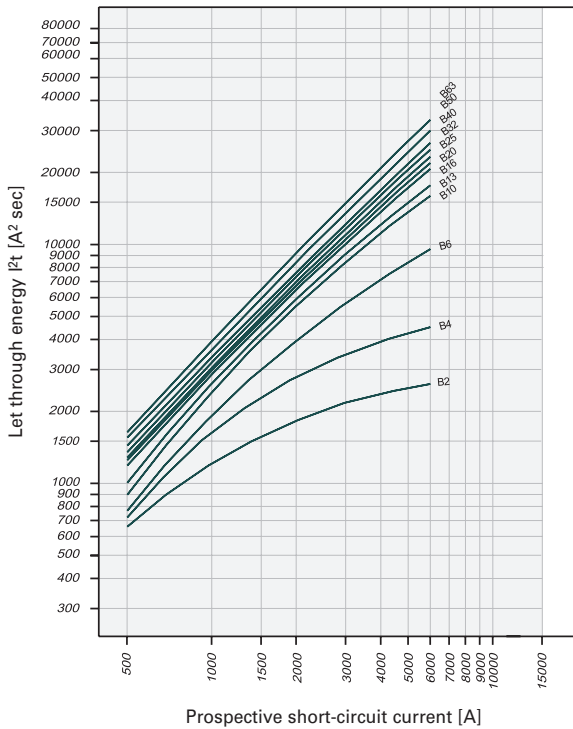

Let-through Energy PL6, Characteristic C, 1-pole

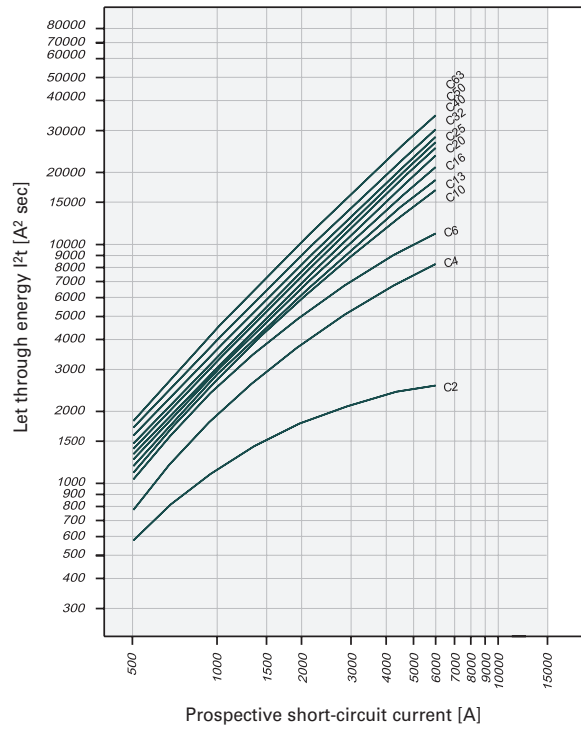

Let-through Energy PL6, Characteristic D, 1-pole

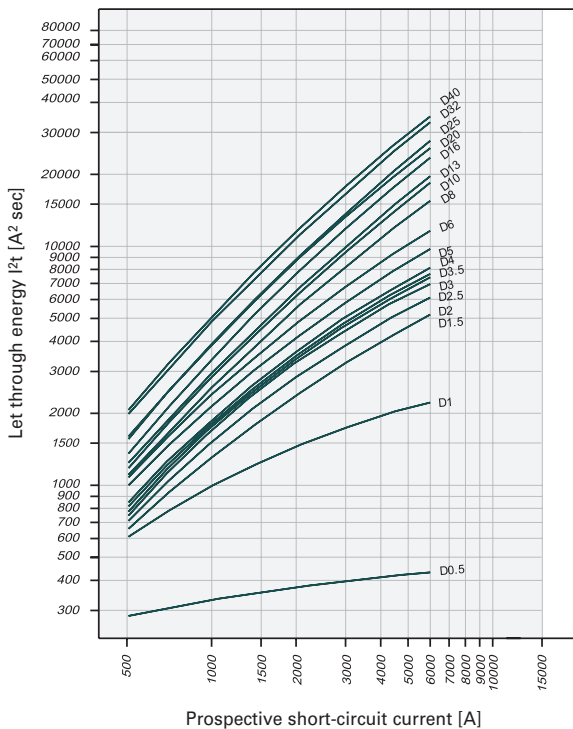

Short-circuit Selectivity PL6 towards DII-DIV fuse link

In case of short-circuit, there is selectivity between the miniature circuit breakers PL6 and the upstream fuses up to the specified values of the selectivity limit current I_s [kA] (i. e. in case of short-circuit currents I_{ks} under I_s only the MCB will trip, in case of short-circuit currents above this value both protective devices will respond).

*) basically in accordance with EN 60898-1 D.5.2.b

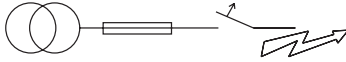

Short-circuit selectivity **Characteristic B** towards fuse link **DII-DIV***)

PL6	DII-DIV gL/gG								
I_n [A]	10	16	20	25	35	50	63	80	100
2	<0.5 ¹⁾	<0.5 ¹⁾	0.8	1.6	6.0 ²⁾	6.0 ²⁾	6.0 ²⁾	6.0 ²⁾	6.0 ²⁾
4	<0.5 ¹⁾	<0.5 ¹⁾	0.6	1.0	3.6	6.0 ²⁾	6.0 ²⁾	6.0 ²⁾	6.0 ²⁾
5	<0.5 ¹⁾	<0.5 ¹⁾	0.6	0.9	2.0	3.5	6.0 ²⁾	6.0 ²⁾	6.0 ²⁾
6		<0.5 ¹⁾	0.6	0.9	1.8	3.2	6.0 ²⁾	6.0 ²⁾	6.0 ²⁾
8		<0.5 ¹⁾	0.5	0.8	1.6	2.6	5.2	6.0 ²⁾	6.0 ²⁾
10			0.5	0.8	1.4	2.2	3.9	6.0 ²⁾	6.0 ²⁾
13			0.5	0.7	1.3	2.0	3.6	5.4	6.0 ²⁾
16				0.6	1.2	1.9	3.2	4.6	6.0 ²⁾
20					1.2	1.8	3.1	4.4	6.0 ²⁾
25					1.2	1.8	3.0	4.2	6.0 ²⁾
32						1.7	2.8	3.9	6.0 ²⁾
40							2.7	3.8	6.0 ²⁾
50							2.5	3.5	5.7
63									5.3

Short-circuit selectivity **Characteristic C** towards fuse link **DII-DIV***)

PL6	DII-DIV gL/gG								
I_n [A]	10	16	20	25	35	50	63	80	100
2	<0.5 ¹⁾	<0.5 ¹⁾	0.8	1.6	6.0 ²⁾	6.0 ²⁾	6.0 ²⁾	6.0 ²⁾	6.0 ²⁾
4	<0.5 ¹⁾	<0.5 ¹⁾	0.6	0.8	1.8	3.6	6.0 ²⁾	6.0 ²⁾	6.0 ²⁾
5	<0.5 ¹⁾	<0.5 ¹⁾	0.6	0.7	1.5	2.7	6.0 ²⁾	6.0 ²⁾	6.0 ²⁾
6		<0.5 ¹⁾	0.5	0.6	1.4	2.4	5.5	6.0 ²⁾	6.0 ²⁾
8		<0.5 ¹⁾	<0.5 ¹⁾	0.6	1.3	2.2	4.7	6.0 ²⁾	6.0 ²⁾
10			<0.5 ¹⁾	0.6	1.3	2.0	3.6	6.0 ²⁾	6.0 ²⁾
13					1.3	1.9	3.3	5.0	6.0 ²⁾
16					1.2	1.8	3.2	4.4	6.0 ²⁾
20					1.2	1.8	3.1	4.1	6.0 ²⁾
25						1.7	2.8	3.8	6.0 ²⁾
32							2.7	3.7	6.0 ²⁾
40								3.5	5.9
50									5.5

Short-circuit selectivity **Characteristic D** towards fuse link **DII-DIV***)

PL6	DII-DIV gL/gG								
I_n [A]	10	16	20	25	35	50	63	80	100
2	<0.5 ¹⁾	<0.5 ¹⁾	0.6	1.0	2.8	5.8	6.0 ²⁾	6.0 ²⁾	6.0 ²⁾
4		<0.5 ¹⁾	0.6	0.9	2.0	3.8	6.0 ²⁾	6.0 ²⁾	6.0 ²⁾
5		<0.5 ¹⁾	0.5	0.7	1.7	3.1	6.0 ²⁾	6.0 ²⁾	6.0 ²⁾
6			0.5	0.7	1.5	2.6	5.3	6.0 ²⁾	6.0 ²⁾
8			<0.5 ¹⁾	0.7	1.4	2.2	3.9	6.0 ²⁾	6.0 ²⁾
10				0.7	1.2	1.9	3.4	5.0	6.0 ²⁾
13					1.2	1.8	3.2	4.6	6.0 ²⁾
16						1.6	2.7	4.0	6.0 ²⁾
20						1.5	2.5	3.5	6.0 ²⁾
25							2.4	3.4	6.0 ²⁾
32								2.8	5.0
40									4.8

¹⁾ Selectivity limit current I_s under 0.5 kA

²⁾ Selectivity limit current I_s = rated breaking capacity I_{cn} of the MCB

Darker areas: no selectivity

Short-circuit Selectivity PL6 towards D01-D03 fuse link

In case of short-circuit, there is selectivity between the miniature circuit breakers PL6 and the upstream fuses up to the specified values of the selectivity limit current I_s [kA] (i. e. in case of short-circuit currents I_{ks} under I_s only the MCB will trip, in case of short-circuit currents above this value both protective devices will respond).

*) basically in accordance with EN 60898-1 D.5.2.b

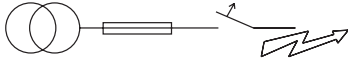

Short-circuit selectivity **Characteristic B** towards fuse link **D01-D03***)

PL6 I_n [A]	D01-D03 gL/gG								
	10	16	20	25	35	50	63	80	100
2	<0.5 ¹⁾	<0.5 ¹⁾	0.6	1.0	6.0 ²⁾	6.0 ²⁾	6.0 ²⁾	6.0 ²⁾	6.0 ²⁾
4	<0.5 ¹⁾	<0.5 ¹⁾	0.5	0.9	2.5	6.0 ²⁾	6.0 ²⁾	6.0 ²⁾	6.0 ²⁾
5		<0.5 ¹⁾	0.5	0.8	1.7	4.0	6.0 ²⁾	6.0 ²⁾	6.0 ²⁾
6		<0.5 ¹⁾	0.5	0.8	1.6	3.6	6.0 ²⁾	6.0 ²⁾	6.0 ²⁾
8			0.5	0.8	1.4	2.8	4.3	6.0 ²⁾	6.0 ²⁾
10			0.5	0.7	1.3	2.4	3.4	6.0 ²⁾	6.0 ²⁾
13			<0.5 ¹⁾	0.7	1.2	2.3	3.2	5.3	6.0 ²⁾
16				0.6	1.1	2.2	2.9	4.6	6.0 ²⁾
20					1.1	2.1	2.8	4.4	6.0 ²⁾
25					1.1	2.0	2.7	4.2	6.0 ²⁾
32						2.0	2.6	4.0	6.0 ²⁾
40							2.5	3.8	6.0 ²⁾
50							2.3	3.4	6.0 ²⁾
63									6.0 ²⁾

Short-circuit selectivity **Characteristic C** towards fuse link **D01-D03***)

PL6 I_n [A]	D01-D03 gL/gG								
	10	16	20	25	35	50	63	80	100
2	<0.5 ¹⁾	<0.5 ¹⁾	0.5	0.7	6.0 ²⁾	6.0 ²⁾	6.0 ²⁾	6.0 ²⁾	6.0 ²⁾
4	<0.5 ¹⁾	<0.5 ¹⁾	<0.5 ¹⁾	0.6	1.6	4.0	6.0 ²⁾	6.0 ²⁾	6.0 ²⁾
5		<0.5 ¹⁾	<0.5 ¹⁾	0.5	1.3	3.1	5.7	6.0 ²⁾	6.0 ²⁾
6		<0.5 ¹⁾	<0.5 ¹⁾	<0.5 ¹⁾	1.2	2.7	4.5	6.0 ²⁾	6.0 ²⁾
8		<0.5 ¹⁾	<0.5 ¹⁾	<0.5 ¹⁾	1.2	2.5	4.0	6.0 ²⁾	6.0 ²⁾
10			<0.5 ¹⁾	<0.5 ¹⁾	1.2	2.3	3.1	5.4	6.0 ²⁾
13					1.1	2.2	3.0	4.9	6.0 ²⁾
16					1.1	2.1	2.8	4.4	6.0 ²⁾
20					1.0	2.0	2.6	4.0	6.0 ²⁾
25					1.9	2.5	3.8	6.0 ²⁾	
32						2.5	3.7	6.0 ²⁾	
40							3.5	6.0 ²⁾	
50								6.0 ²⁾	

Short-circuit selectivity **Characteristic D** towards fuse link **D01-D03***)

PL6 I_n [A]	D01-D03 gL/gG								
	10	16	20	25	35	50	63	80	100
2	<0.5 ¹⁾	<0.5 ¹⁾	0.6	0.8	2.2	6.0 ²⁾	6.0 ²⁾	6.0 ²⁾	6.0 ²⁾
4		<0.5 ¹⁾	0.5	0.7	1.7	4.6	6.0 ²⁾	6.0 ²⁾	6.0 ²⁾
5		<0.5 ¹⁾	<0.5 ¹⁾	0.6	1.5	3.5	5.8	6.0 ²⁾	6.0 ²⁾
6			<0.5 ¹⁾	0.5	1.3	2.9	4.5	6.0 ²⁾	6.0 ²⁾
8			<0.5 ¹⁾	0.5	1.2	2.4	3.5	6.0 ²⁾	6.0 ²⁾
10				0.5	1.1	2.2	3.0	5.0	6.0 ²⁾
13					1.1	2.1	2.9	4.6	6.0 ²⁾
16						1.9	2.6	3.9	6.0 ²⁾
20						1.7	2.3	3.5	6.0 ²⁾
25							2.2	3.4	6.0 ²⁾
32								2.9	6.0 ²⁾
40									5.7

¹⁾ Selectivity limit current I_s under 0.5 kA

²⁾ Selectivity limit current I_s = rated breaking capacity I_{cn} of the MCB

Darker areas: no selectivity

Short-circuit Selectivity PL6 towards NH-00 fuse link

In case of short-circuit, there is selectivity between the miniature circuit breakers PL6 and the upstream fuses up to the specified values of the selectivity limit current I_s [kA] (i. e. in case of short-circuit currents I_{ks} under I_s only the MCB will trip, in case of short-circuit currents above this value both protective devices will respond).

*) basically in accordance with EN 60898-1 D.5.2.b

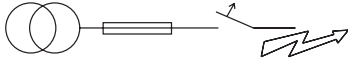

Short-circuit selectivity **Characteristic B** towards fuse link **NH-00***

PL6 I_n [A]	NH-00 gL/gG											
	16	20	25	32	35	40	50	63	80	100	125	160
2	<0.5 ¹⁾	0.5	1.0	2.5	6.0 ²⁾	6.0 ²⁾	6.0 ²⁾	6.0 ²⁾	6.0 ²⁾	6.0 ²⁾	6.0 ²⁾	6.0 ²⁾
4	<0.5 ¹⁾	<0.5 ¹⁾	0.8	1.3	2.3	4.3	6.0 ²⁾	6.0 ²⁾	6.0 ²⁾	6.0 ²⁾	6.0 ²⁾	6.0 ²⁾
5	<0.5 ¹⁾	<0.5 ¹⁾	0.7	1.1	1.6	2.2	3.6	4.8	6.0 ²⁾	6.0 ²⁾	6.0 ²⁾	6.0 ²⁾
6	<0.5 ¹⁾	<0.5 ¹⁾	0.7	1.1	1.5	2.0	3.3	4.3	6.0 ²⁾	6.0 ²⁾	6.0 ²⁾	6.0 ²⁾
8	<0.5 ¹⁾	<0.5 ¹⁾	0.6	1.0	1.3	1.7	2.6	3.3	5.2	6.0 ²⁾	6.0 ²⁾	6.0 ²⁾
10	<0.5 ¹⁾	0.6	0.9	1.2	1.5	2.2	2.7	4.0	6.0 ²⁾	6.0 ²⁾	6.0 ²⁾	
13	<0.5 ¹⁾	0.6	0.8	1.1	1.4	2.1	2.6	3.8	6.0 ²⁾	6.0 ²⁾	6.0 ²⁾	
16		0.5	0.7	1.0	1.3	1.9	2.4	3.4	6.0 ²⁾	6.0 ²⁾	6.0 ²⁾	
20			0.7	1.0	1.3	1.9	2.4	3.3	6.0 ²⁾	6.0 ²⁾	6.0 ²⁾	
25				0.7	1.0	1.3	1.8	2.3	3.2	5.7	6.0 ²⁾	6.0 ²⁾
32					0.9	1.2	1.7	2.2	3.1	5.4	6.0 ²⁾	6.0 ²⁾
40								2.1	3.0	5.1	6.0 ²⁾	6.0 ²⁾
50								1.9	2.8	4.7	6.0 ²⁾	6.0 ²⁾
63									4.4	6.0 ²⁾	6.0 ²⁾	

Short-circuit selectivity **Characteristic C** towards fuse link **NH-00***

PL6 I_n [A]	NH-00 gL/gG													
	16	20	25	32	35	40	50	63	80	100	125	160		
2	<0.5 ¹⁾	0.6	1.0	2.5	6.0 ²⁾	6.0 ²⁾	6.0 ²⁾	6.0 ²⁾	6.0 ²⁾	6.0 ²⁾	6.0 ²⁾	6.0 ²⁾		
4	<0.5 ¹⁾	<0.5 ¹⁾	0.7	1.0	1.5	2.1	3.6	5.0	6.0 ²⁾	6.0 ²⁾	6.0 ²⁾	6.0 ²⁾		
5	<0.5 ¹⁾	<0.5 ¹⁾	0.6	0.8	1.2	1.7	2.8	3.8	6.0 ²⁾	6.0 ²⁾	6.0 ²⁾	6.0 ²⁾		
6	<0.5 ¹⁾	<0.5 ¹⁾	0.5	0.8	1.2	1.5	2.5	3.3	5.7	6.0 ²⁾	6.0 ²⁾	6.0 ²⁾		
8	<0.5 ¹⁾	<0.5 ¹⁾	0.5	0.8	1.1	1.5	2.3	2.9	4.9	6.0 ²⁾	6.0 ²⁾	6.0 ²⁾		
10			0.5	0.7	1.0	1.4	2.0	2.5	3.8	6.0 ²⁾	6.0 ²⁾	6.0 ²⁾		
13					1.0	1.3	1.9	2.4	3.6	6.0 ²⁾	6.0 ²⁾	6.0 ²⁾		
16						1.0	1.3	1.8	2.3	3.3	6.0 ²⁾	6.0 ²⁾		
20							1.0	1.2	1.7	2.2	3.2	5.5	6.0 ²⁾	6.0 ²⁾
25								1.6	2.1	3.0	5.2	6.0 ²⁾	6.0 ²⁾	
32									2.1	2.9	5.0	6.0 ²⁾	6.0 ²⁾	
40										2.8	4.8	6.0 ²⁾	6.0 ²⁾	
50											4.5	6.0 ²⁾	6.0 ²⁾	
63												5.9	6.0 ²⁾	

Short-circuit selectivity **Characteristic D** towards fuse link **NH-00***

PL6 I_n [A]	NH-00 gL/gG											
	16	20	25	32	35	40	50	63	80	100	125	160
2	<0.5 ¹⁾	<0.5 ¹⁾	0.8	1.3	2.1	3.1	6.0 ²⁾	6.0 ²⁾	6.0 ²⁾	6.0 ²⁾	6.0 ²⁾	6.0 ²⁾
4	<0.5 ¹⁾	<0.5 ¹⁾	0.7	1.0	1.6	2.2	3.8	5.2	6.0 ²⁾	6.0 ²⁾	6.0 ²⁾	6.0 ²⁾
5		<0.5 ¹⁾	0.6	0.9	1.4	1.9	3.2	4.1	6.0 ²⁾	6.0 ²⁾	6.0 ²⁾	6.0 ²⁾
6		<0.5 ¹⁾	0.5	0.8	1.2	1.6	2.6	3.3	5.5	6.0 ²⁾	6.0 ²⁾	6.0 ²⁾
8			0.5	0.8	1.1	1.5	2.2	2.7	4.1	6.0 ²⁾	6.0 ²⁾	6.0 ²⁾
10			0.5	0.7	1.0	1.3	1.9	2.5	3.6	6.0 ²⁾	6.0 ²⁾	6.0 ²⁾
13					1.0	1.3	1.9	2.3	3.4	6.0 ²⁾	6.0 ²⁾	6.0 ²⁾
16						1.1	1.6	2.0	3.0	5.5	6.0 ²⁾	6.0 ²⁾
20							1.4	1.8	2.8	5.0	6.0 ²⁾	6.0 ²⁾
25								1.8	2.7	4.8	6.0 ²⁾	6.0 ²⁾
32									2.4	4.1	6.0 ²⁾	6.0 ²⁾
40										4.0	6.0 ²⁾	6.0 ²⁾

¹⁾ Selectivity limit current I_s under 0.5 kA

²⁾ Selectivity limit current I_s = rated breaking capacity I_{cn} of the MCB

Darker areas: no selectivity

SG06211



Description

- High-quality miniature circuit breakers for DC-applications
- Contact position indicator red - green
- Guide for secure terminal connection
- 3-position DIN rail clip, permits removal from existing busbar system
- Comprehensive range of accessories can be mounted subsequently
- Rated currents up to 50 A
- Tripping Characteristic C
- Rated breaking capacity 10 kA according to IEC/EN 60947-2
- Up to 250 V DC per pole

Rated current I_n (A)	Type Designation	Article No.	Units per package
----------------------------	---------------------	-------------	----------------------

10 kA, Characteristic C

SG06211



1-pole

1	PL7-C1/1-DC	264851	12/120
2	PL7-C2/1-DC	264883	12/120
3	PL7-C3/1-DC	264884	12/120
4	PL7-C4/1-DC	264885	12/120
6	PL7-C6/1-DC	264886	12/120
10	PL7-C10/1-DC	264887	12/120
13	PL7-C13/1-DC	264888	12/120
16	PL7-C16/1-DC	264889	12/120
20	PL7-C20/1-DC	264890	12/120
25	PL7-C25/1-DC	264891	12/120
32	PL7-C32/1-DC	264892	12/120
40	PL7-C40/1-DC	264893	12/120
50	PL7-C50/1-DC	264894	12/120

SG06411



2-pole

1	PL7-C1/2-DC	264895	6/60
2	PL7-C2/2-DC	264896	6/60
3	PL7-C3/2-DC	264897	6/60
4	PL7-C4/2-DC	264898	6/60
6	PL7-C6/2-DC	264899	6/60
10	PL7-C10/2-DC	264900	6/60
13	PL7-C13/2-DC	264901	6/60
16	PL7-C16/2-DC	264902	6/60
20	PL7-C20/2-DC	264903	6/60
25	PL7-C25/2-DC	264904	6/60
32	PL7-C32/2-DC	264905	6/60
40	PL7-C40/2-DC	264906	6/60
50	PL7-C50/2-DC	264907	6/60

Specifications | Miniature Circuit Breakers PL7-DC

Description

- High selectivity between MCB and back-up fuse due to low let-through energy
- Compatible with standard busbar
- Twin-purpose terminal (lift/open-mouthed) above and below
- Busbar positioning optionally above or below
- Meets the requirements of insulation co-ordination, distance between contacts ≥ 4 mm, for secure isolation
- Rated breaking capacity 10 kA according to IEC/EN 60947
- Rated voltage to 250 V (per pole), $\tau = 4$ ms
- Take into account polarity!

Accessories:

Auxiliary switch for subsequent installation	ZP-IHK	286052
	ZP-WHK	286053
Tripping signal switch for subsequent installation	ZP-NHK	248437
Remote control and automatic switching device	Z-FW/LP	248296
Shunt trip release	ZP-ASA/..	248438, 248439
Undervoltage release	Z-USA/..	248288-248291
Additional terminal 35 mm ²	BB-UL-TEPA/35	169823
Switching interlock	Z-IS/SPE-1TE	274418

Technical Data

		PL7-DC
Electrical		
Design according to		IEC/EN 60947-2
Current test marks as printed onto the device		
Rated voltage DC		1-2 A types: 220 V (per pole) 3-50 A types: 250 V (per pole)
Rated frequency		50/60 Hz
Rated breaking capacity according to IEC/EN 60947-2		10 kA
Characteristic		C
Back-up fuse		max. 100 A gL
Selectivity class		3
Rated impulse withstand voltage	U_{imp}	4 kV (1.2/50 μ s)
Endurance		
electrical components		$\geq 4,000$ switching operations
mechanical components		$\geq 20,000$ switching operations
Line voltage connection		at will (above/below)
Mechanical		
Frame size		45 mm
Device height		80 mm
Device width		17.5 mm per pole (1MU)
Mounting		quick fastening with 3 lock-in positions on DIN rail IEC/EN 60715
Degree of protection		IP20
Upper and lower terminals		open-mouthed/lift terminals
Terminal protection		finger and hand touch safe, DGUV VS3, EN 50274
Terminal capacity		1-25 mm ²
Terminal torque		2-2.4 Nm
Busbar thickness		0.8 - 2 mm
Mounting		independent of position
Operation temperature		-25°C to +55°C
Storage- and transport temperature		-40°C up to +60°C

Note: not for PV string protection!

Connection diagrams

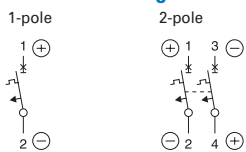

Dimensions (mm)

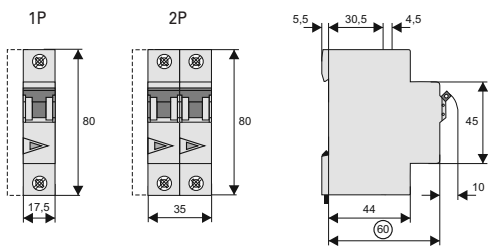

Connection examples

Connection example at 250 V=, 1-pole

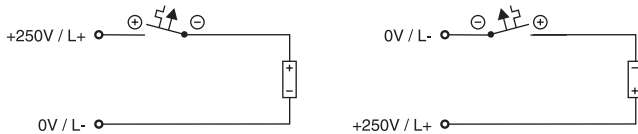

Connection example at 500 V=, 2-pole

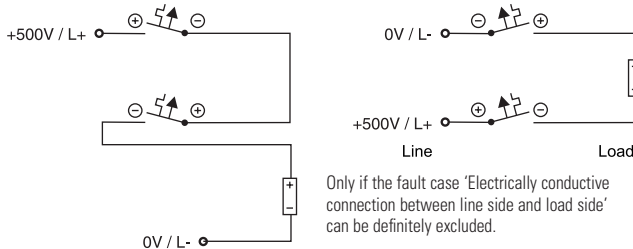

Only if the fault case 'Electrically conductive connection between line side and load side' can be definitely excluded.

Tripping characteristic PL7-DC

Type C

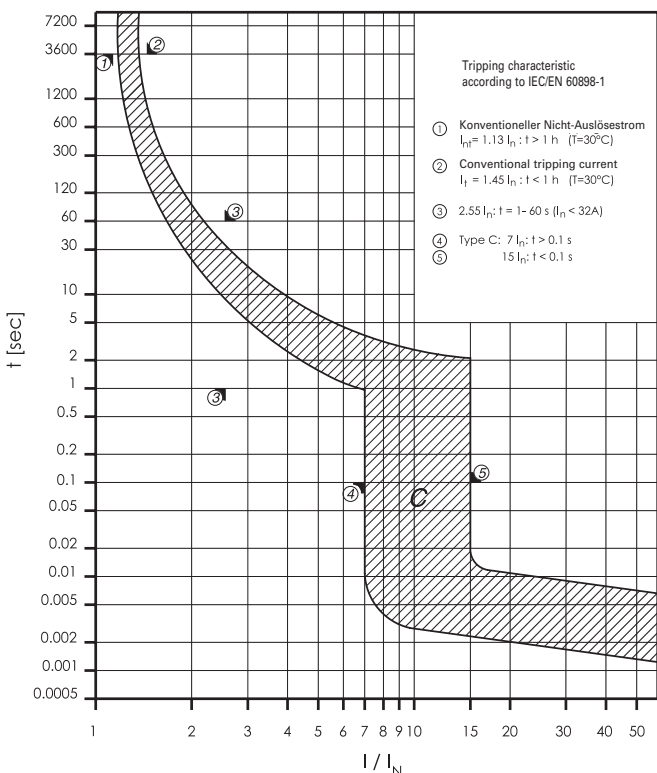

Let-through Energy PL7-DC

Type C, 250 V d.c., $\tau = 5 \text{ ms}$ (according to IEC/EN 60947-2)

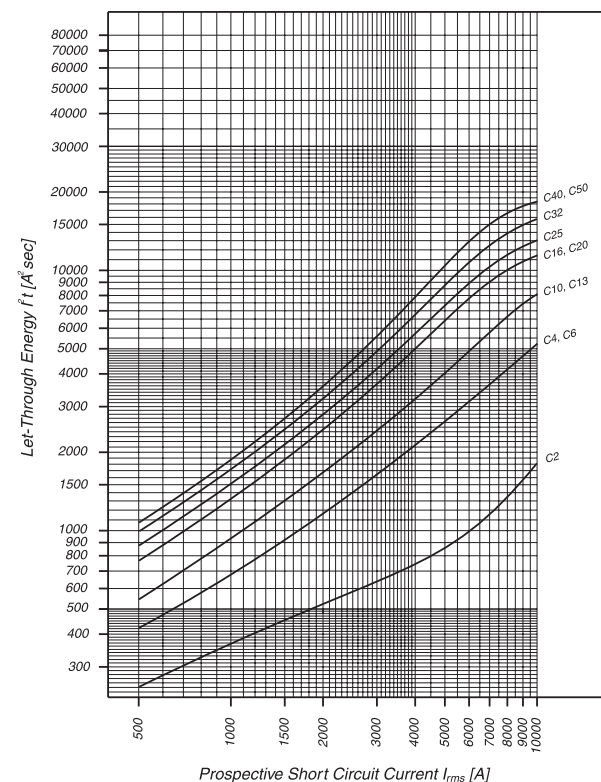

SG33911

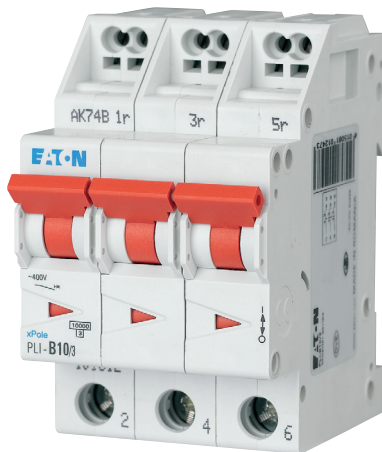

Description

- Contact position indicator red - green
- Two plug-in terminals at the output side
- Single-wire lines can be connected without tools
- Plug-in terminals can be opened conveniently by means of a screwdriver
- Guide for secure terminal connection below
- 3-position DIN rail clip, permits removal from existing busbar system
- Comprehensive range of accessories can be mounted subsequently
- Rated currents up to 16 A
- Tripping characteristics B, C, D
- Rated breaking capacity 10 kA according to IEC/EN 60898-1

Miniature Circuit Breakers with Plug-in Terminals at the output side PLI

Rated current I_n (A)	Type Designation	Article No.	Units per package
----------------------------	---------------------	-------------	----------------------

10 kA, Characteristic B

SG11511



1-pole

2	PLI-B2/1	101245	12/120
4	PLI-B4/1	101246	12/120
6	PLI-B6/1	101247	12/120
8	PLI-B8/1	101248	12/120
10	PLI-B10/1	101249	12/120
13	PLI-B13/1	101250	12/120
16	PLI-B16/1	101251	12/120

SG20011



1+N-pole 2 MU

2	PLI-B2/1N	101266	1/60
4	PLI-B4/1N	101267	1/60
6	PLI-B6/1N	101268	1/60
8	PLI-B8/1N	101269	1/60
10	PLI-B10/1N	101270	1/60
13	PLI-B13/1N	101271	1/60
16	PLI-B16/1N	101272	1/60

SG19511



2-pole

2	PLI-B2/2	101287	1/60
4	PLI-B4/2	101288	1/60
6	PLI-B6/2	101289	1/60
8	PLI-B8/2	101290	1/60
10	PLI-B10/2	101291	1/60
13	PLI-B13/2	101292	1/60
16	PLI-B16/2	101293	1/60

SG33911



3-pole

2	PLI-B2/3	101308	1/40
4	PLI-B4/3	101309	1/40
6	PLI-B6/3	101310	1/40
8	PLI-B8/3	101311	1/40
10	PLI-B10/3	101312	1/40
13	PLI-B13/3	101313	1/40
16	PLI-B16/3	101314	1/40

SG19211



3+N-pole

2	PLI-B2/3N	101329	1/30
4	PLI-B4/3N	101330	1/30
6	PLI-B6/3N	101331	1/30
8	PLI-B8/3N	101332	1/30
10	PLI-B10/3N	101333	1/30
13	PLI-B13/3N	101334	1/30
16	PLI-B16/3N	101335	1/30

SG39011



4-pole

2	PLI-B2/4	101350	1/30
4	PLI-B4/4	101351	1/30
6	PLI-B6/4	101352	1/30
8	PLI-B8/4	101353	1/30
10	PLI-B10/4	101354	1/30
13	PLI-B13/4	101355	1/30
16	PLI-B16/4	101356	1/30

Explanation PLI:

P = xPole, L = Miniature Circuit Breaker, I = 10 kA, Plug-in Terminals

1.5

Miniature Circuit Breakers (MCBs)

xPole

Miniature Circuit Breakers with Plug-in Terminals at the output side PLI

Rated current I_n (A)	Type Designation	Article No.	Units per package
----------------------------	---------------------	-------------	----------------------

10 kA, Characteristic C

SG11511



1-pole

2	PLI-C2/1	101252	12/120
4	PLI-C4/1	101253	12/120
6	PLI-C6/1	101254	12/120
8	PLI-C8/1	101255	12/120
10	PLI-C10/1	101256	12/120
13	PLI-C13/1	101257	12/120
16	PLI-C16/1	101258	12/120

SG20011



1+N-pole 2 MU

2	PLI-C2/1N	101273	1/60
4	PLI-C4/1N	101274	1/60
6	PLI-C6/1N	101275	1/60
8	PLI-C8/1N	101276	1/60
10	PLI-C10/1N	101277	1/60
13	PLI-C13/1N	101278	1/60
16	PLI-C16/1N	101279	1/60

SG19511



2-pole

2	PLI-C2/2	101294	1/60
4	PLI-C4/2	101295	1/60
6	PLI-C6/2	101296	1/60
8	PLI-C8/2	101297	1/60
10	PLI-C10/2	101298	1/60
13	PLI-C13/2	101299	1/60
16	PLI-C16/2	101300	1/60

SG33911



3-pole

2	PLI-C2/3	101315	1/40
4	PLI-C4/3	101316	1/40
6	PLI-C6/3	101317	1/40
8	PLI-C8/3	101318	1/40
10	PLI-C10/3	101319	1/40
13	PLI-C13/3	101320	1/40
16	PLI-C16/3	101321	1/40

SG19211



3+N-pole

2	PLI-C2/3N	101336	1/30
4	PLI-C4/3N	101337	1/30
6	PLI-C6/3N	101338	1/30
8	PLI-C8/3N	101339	1/30
10	PLI-C10/3N	101340	1/30
13	PLI-C13/3N	101341	1/30
16	PLI-C16/3N	101342	1/30

SG39011



4-pole

2	PLI-C2/4	101357	1/30
4	PLI-C4/4	101358	1/30
6	PLI-C6/4	101359	1/30
8	PLI-C8/4	101360	1/30
10	PLI-C10/4	101361	1/30
13	PLI-C13/4	101362	1/30
16	PLI-C16/4	101363	1/30

Explanation PLI:

P = xPole, L = Miniature Circuit Breaker, I = 10 kA, Plug-in Terminals

Rated current I_n (A)	Type Designation	Article No.	Units per package
----------------------------	---------------------	-------------	----------------------

10 kA, Characteristic D

SG11511



1-pole

2	PLI-D2/1	101259	12/120
4	PLI-D4/1	101260	12/120
6	PLI-D6/1	101261	12/120
8	PLI-D8/1	101262	12/120
10	PLI-D10/1	101263	12/120
13	PLI-D13/1	101264	12/120
16	PLI-D16/1	101265	12/120

SG20011



1+N-pole 2 MU

2	PLI-D2/1N	101280	1/60
4	PLI-D4/1N	101281	1/60
6	PLI-D6/1N	101282	1/60
8	PLI-D8/1N	101283	1/60
10	PLI-D10/1N	101284	1/60
13	PLI-D13/1N	101285	1/60
16	PLI-D16/1N	101286	1/60

SG19511



2-pole

2	PLI-D2/2	101301	1/60
4	PLI-D4/2	101302	1/60
6	PLI-D6/2	101303	1/60
8	PLI-D8/2	101304	1/60
10	PLI-D10/2	101305	1/60
13	PLI-D13/2	101306	1/60
16	PLI-D16/2	101307	1/60

SG33911



3-pole

2	PLI-D2/3	101322	1/40
4	PLI-D4/3	101323	1/40
6	PLI-D6/3	101324	1/40
8	PLI-D8/3	101325	1/40
10	PLI-D10/3	101326	1/40
13	PLI-D13/3	101327	1/40
16	PLI-D16/3	101328	1/40

SG19211



3+N-pole

2	PLI-D2/3N	101343	1/30
4	PLI-D4/3N	101344	1/30
6	PLI-D6/3N	101345	1/30
8	PLI-D8/3N	101346	1/30
10	PLI-D10/3N	101347	1/30
13	PLI-D13/3N	101348	1/30
16	PLI-D16/3N	101349	1/30

SG39011



4-pole

2	PLI-D2/4	101364	1/30
4	PLI-D4/4	101365	1/30
6	PLI-D6/4	101366	1/30
8	PLI-D8/4	101367	1/30
10	PLI-D10/4	101368	1/30
13	PLI-D13/4	101369	1/30
16	PLI-D16/4	101370	1/30

Specifications | Miniature Circuit Breakers with Plug-in Terminals at the output side PLI

Description

- High selectivity between MCB and back-up fuse due to low let-through energy
- Plug-in terminals above (at the output side)
- Two terminal points per pole
- Single-wire lines can be connected without tools
- The conductor can be removed from the plug-in terminal and single- or fine-wire lines can be connected by means of a screwdriver DIN 5264 Type A and Type B (maximum blade width 3 mm)
- Twin-purpose terminal (lift/open-mouthed) below
- Compatible with standard busbar below
- Meets the requirements of insulation co-ordination, distance between contacts ≥ 4 mm, for secure isolation
- Suitable for applications up to 48 V DC

Accessories:

Auxiliary switch for subsequent installation	ZP-IHK	286052
	ZP-WHK	286053
Tripping signal switch for subsequent installation	ZP-NHK	248437
Remote control and automatic switching device	Z-FW/LP	248296
Shunt trip release	ZP-ASA/..	248438, 248439
Undervoltage release	Z-USA/..	248288-248291
Additional terminal 35 mm ²	BB-UL-TEPA/35	169823
Switching interlock	Z-IS/SPE-1TE	274418

Technical Data

		PLI
Electrical		
Design according to		IEC/EN 60898-1
Current test marks as printed onto the device		
Rated voltage	U_n	AC: 230/400 V DC: 48 V (per pole)
Rated frequency		50/60 Hz
Rated breaking capacity according to IEC/EN 60898-1	I_{cn}	10 kA
Characteristic		B, C, D
Back-up fuse		max. 125 A gL
Selectivity class		3
Rated impulse withstand voltage	U_{imp}	4 kV (1.2/50 μ s)
Endurance electrical components		$\geq 8,000$ switching operations
Line voltage connection		below
Mechanical		
Frame size		45 mm
Device height		80 mm
Device width		17.5 mm per pole (1MU)
Mounting		quick fastening with 3 lock-in positions on DIN rail IEC/EN 60715
Degree of protection		IP20
Upper terminals		twin plug-in terminals
Lower terminals		open-mouthed/lift terminals
Terminal protection		finger and hand touch safe, DGUV VS3, EN 50274
Upper terminal capacity		1-4 mm ² , with wire end sleeve 1-2.5 mm ²
Lower terminal capacity		1-25 mm ²
Terminal torque		2-2.4 Nm
Busbar thickness		0.8 - 2 mm
Mounting		independent of position

Connection diagrams

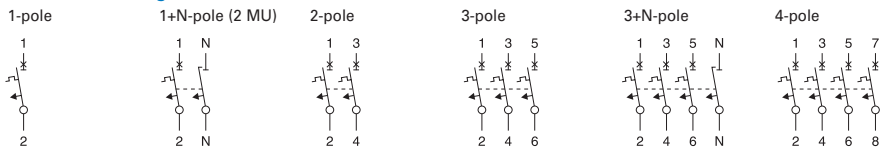

Dimensions (mm)

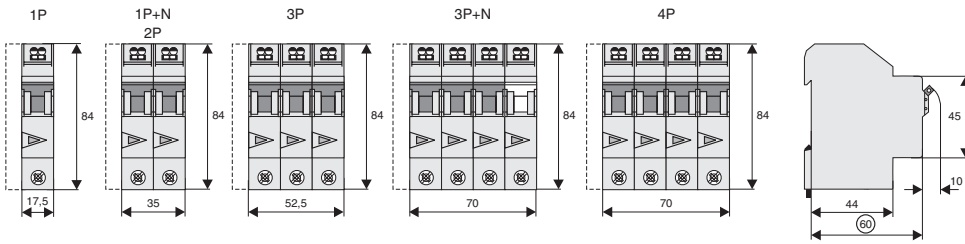

SG14511



Description

- Top-quality miniature circuit breakers 1P+N with a width of 1 module unit requiring little space for installation
- Contact position indicator red - green
- Guide for secure terminal connection
- Comprehensive range of accessories can be mounted subsequently
- Rated currents up to 40 A
- Tripping characteristics B, C
- Rated breaking capacity 6 kA according to IEC/EN 60898-1

Rated current I_n (A)	Type Designation	Article No.	Units per package
----------------------------	---------------------	-------------	----------------------

6 kA, Characteristic B

1+N-pole

6	PLN6-B6/1N	263161	12/120
10	PLN6-B10/1N	263162	12/120
13	PLN6-B13/1N	263163	12/120
16	PLN6-B16/1N	263164	12/120
20	PLN6-B20/1N	263165	12/120
25	PLN6-B25/1N	263166	12/120
32	PLN6-B32/1N	263167	12/120
40	PLN6-B40/1N	263168	12/120

SG14511



6 kA, Characteristic C

1+N-pole

2	PLN6-C2/1N	263169	12/120
4	PLN6-C4/1N	263170	12/120
6	PLN6-C6/1N	263171	12/120
10	PLN6-C10/1N	263172	12/120
13	PLN6-C13/1N	263173	12/120
16	PLN6-C16/1N	263174	12/120
20	PLN6-C20/1N	263175	12/120
25	PLN6-C25/1N	263176	12/120
32	PLN6-C32/1N	263177	12/120
40	PLN6-C40/1N	263178	12/120

SG14511



SG15711



Description

- Top-quality miniature circuit breakers 1P+N with a width of 1 module unit requiring little space for installation
- Contact position indicator red - green
- Guide for secure terminal connection
- Comprehensive range of accessories can be mounted subsequently
- Rated currents up to 40 A
- Tripping characteristics B, C
- Rated breaking capacity 4.5 kA according to IEC/EN 60898-1

Rated current I_n (A)	Type Designation	Article No.	Units per package
----------------------------	---------------------	-------------	----------------------

4.5 kA, Characteristic B

SG15711



1+N-pole

6	PLN4-B6/1N	263179	12/120
10	PLN4-B10/1N	263180	12/120
13	PLN4-B13/1N	263181	12/120
16	PLN4-B16/1N	263182	12/120
20	PLN4-B20/1N	263183	12/120
25	PLN4-B25/1N	263184	12/120
32	PLN4-B32/1N	263185	12/120
40	PLN4-B40/1N	263186	12/120

4.5 kA, Characteristic C

SG15711



1+N-pole

6	PLN4-C6/1N	263189	12/120
10	PLN4-C10/1N	263190	12/120
13	PLN4-C13/1N	263191	12/120
16	PLN4-C16/1N	263192	12/120
20	PLN4-C20/1N	263193	12/120
25	PLN4-C25/1N	263194	12/120
32	PLN4-C32/1N	263195	12/120
40	PLN4-C40/1N	263196	12/120

Specifications | Miniature Circuit Breakers PLN6, PLN4

Description

- High selectivity between MCB and back-up fuse due to low let-through energy
- Busbar positioning optionally above or below
- Compatible with standard busbar
- Switching toggle in colour designating the rated current
- Meets the requirements of insulation co-ordination, distance between contacts ≥ 4 mm, for secure isolation
- 1-pole breaking capacity $I_{cn1} = 3$ kA

Accessories:

Auxiliary switch for subsequent installation	ZP-IHK	286052
	ZP-WHK	286053
Tripping signal switch for subsequent installation	ZP-NHK	248437
Remote control and automatic switching device	Z-FW/LP	248296
Shunt trip release	ZP-ASA/..	248438, 248439
Undervoltage release	Z-USA/..	248288-248291

Busbars: see capter busbar systems

Technical Data

		PLN6, PLN4
Electrical		
Design according to		IEC/EN 60898-1
Current test marks as printed onto the device		
Rated voltage	U_n	230 VAC
Rated frequency		50/60 Hz
Rated breaking capacity according to IEC/EN 60898-1	I_{cn}	
PLN6		6 kA
PLN4		4.5 kA
Characteristic		B, C
Back-up fuse		
>6 kA		max. 100 A gL/gG
>4.5 kA		max. 80 A gL/gG
Selectivity class		3
Endurance electrical components		$\geq 8,000$ switching operations
Mechanical		
Frame size		45 mm
Device height		80 mm
Device width		17.5 mm (1MU for 1+N)
Mounting		quick fastening with 2 lock-in positions on DIN rail IEC/EN 60715
Degree of protection		IP20
Upper and lower terminals		open-mouthed/lift terminals
Terminal protection		finger and hand touch safe, DGUV VS3, EN 50274
Terminal capacity		1-16 mm ²

Connection diagram

1+N-pole

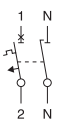

Dimensions (mm)

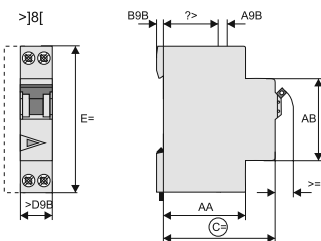

Load Capacity PLN6

Load capacity in case of MCB block installation

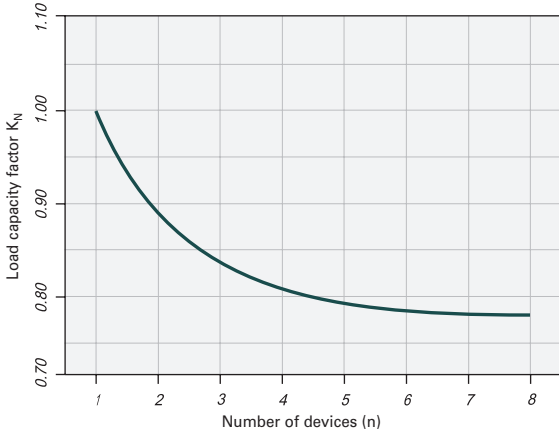

Current carrying capacity at ambient temperature ($I_n = 2-13 A$)

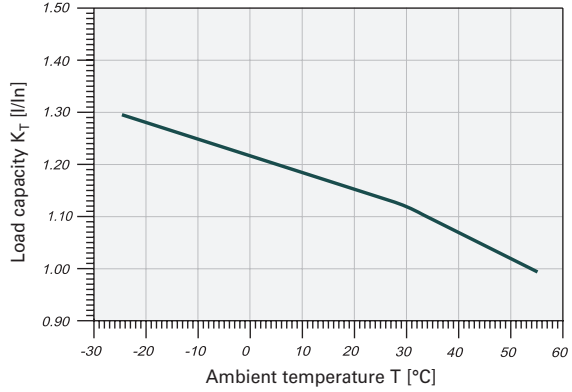

Current carrying capacity at ambient temperature ($I_n = 16-25 A$)

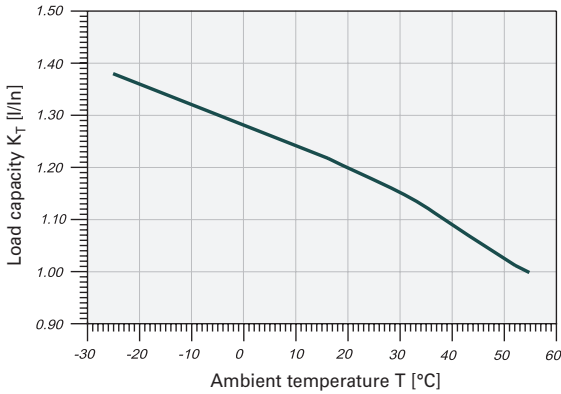

Current carrying capacity at ambient temperature ($I_n = 32, 40 A$)

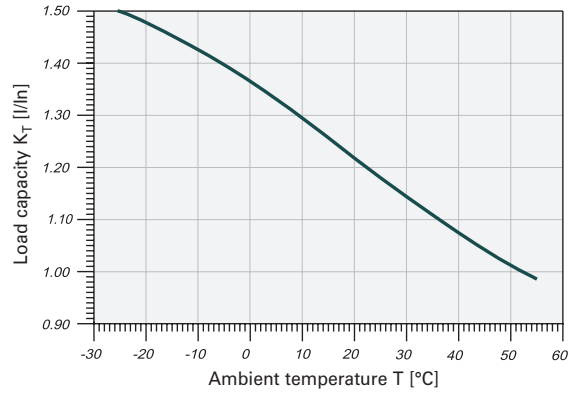

Permitted permanent load at ambient temperature T (°C) with n devices: $I_{DL} = I_n K_T(T) K_N(N)$.

Let-through Energy PLN6

Maximum let-through energy PLN6, Characteristic B

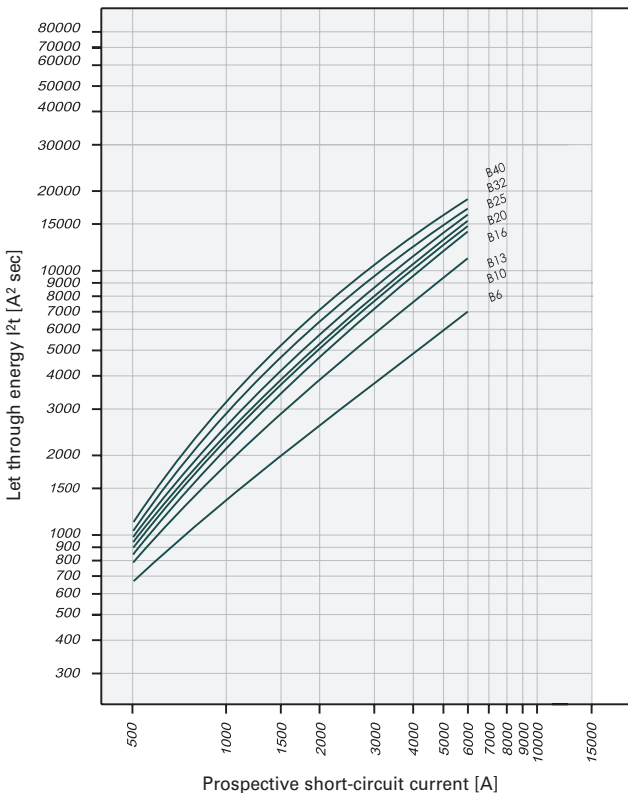

Maximum let-through energy PLN6, Characteristic C

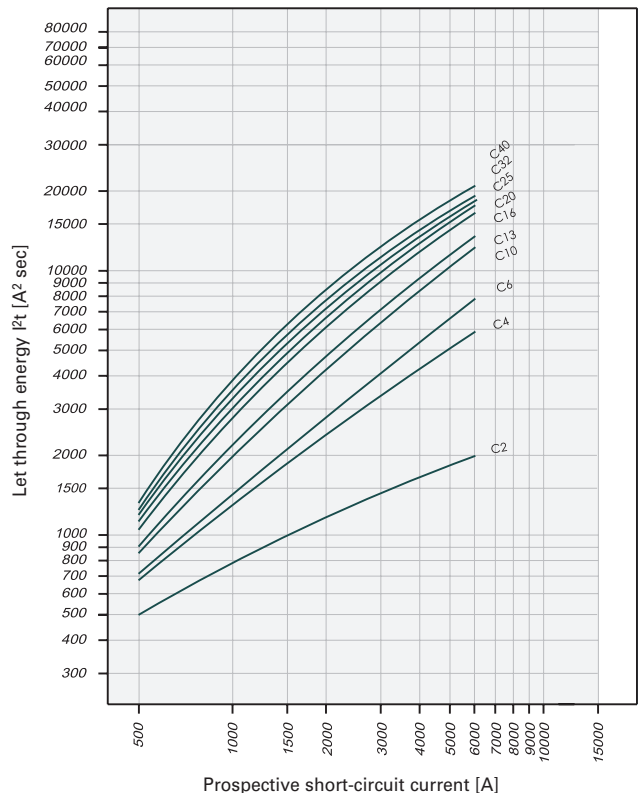

Determined according to 60898-1.

Short-circuit Selectivity PLN6

In case of short-circuit, there is selectivity between the miniature circuit breakers PLN6 and the upstream fuses up to the specified values of the selectivity limit current I_s [kA] (i. e. in case of short-circuit currents I_{ks} under I_s only the MCB will trip, in case of short-circuit currents above this value both protective devices will respond).

*) basically in accordance with EN 60898-1 D.5.2.b

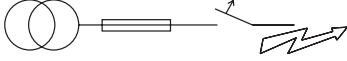

Short-circuit selectivity **Characteristic B** towards fuse link **DII-DIV***)

PLN6	DII-DIV gL/gG						
I_n [A]	20	25	35	50	63	80	100
6	0.7	1.2	2.9	4.5	6.0 ²⁾	6.0 ²⁾	6.0 ²⁾
10	0.6	0.9	1.9	3.1	5.7	6.0 ²⁾	6.0 ²⁾
13	0.5	0.7	1.5	2.5	4.5	6.0 ²⁾	6.0 ²⁾
16	0.5	0.7	1.4	2.3	4.3	6.0 ²⁾	6.0 ²⁾
20	0.5	0.7	1.4	2.2	4.0	6.0 ²⁾	6.0 ²⁾
25	0.5	0.6	1.3	2.0	3.8	5.8	6.0 ²⁾
32	0.5	0.6	1.2	1.8	3.4	5.5	6.0 ²⁾
40	<0.5 ¹⁾	0.6	1.1	1.7	3.1	5.0	6.0 ²⁾

Short-circuit selectivity **Characteristic C** towards fuse link **DII-DIV***)

PLN6	DII-DIV gL/gG						
I_n [A]	20	25	35	50	63	80	100
2	1.5	3.8	6.0 ²⁾	6.0 ²⁾	6.0 ²⁾	6.0 ²⁾	6.0 ²⁾
4	0.7	1.2	3.3	6.0 ²⁾	6.0 ²⁾	6.0 ²⁾	6.0 ²⁾
6	0.7	1.1	2.6	4.5	6.0 ²⁾	6.0 ²⁾	6.0 ²⁾
10	0.5	0.8	1.7	2.8	5.2	6.0 ²⁾	6.0 ²⁾
13	0.5	0.7	1.5	2.5	4.5	6.0 ²⁾	6.0 ²⁾
16	0.5	0.6	1.2	2.0	3.6	5.6	6.0 ²⁾
20	0.5	0.6	1.2	1.8	3.3	5.1	6.0 ²⁾
25	<0.5 ¹⁾	0.6	1.1	1.7	3.0	4.8	6.0 ²⁾
32	<0.5 ¹⁾	0.6	1.0	1.6	2.8	4.5	6.0 ²⁾
40	<0.5 ¹⁾	0.6	1.0	1.5	2.6	4.0	6.0 ²⁾

Short-circuit selectivity **Characteristic B** towards fuse link **D01-D03***)

PLN6	D01-D03 gL/gG						
I_n [A]	20	25	35	50	63	80	100
6	0.6	0.9	2.5	5.5	6.0 ²⁾	6.0 ²⁾	6.0 ²⁾
10	0.5	0.8	1.6	3.4	5.0	6.0 ²⁾	6.0 ²⁾
13	0.5	0.7	1.3	2.7	4.0	6.0 ²⁾	6.0 ²⁾
16	0.5	0.6	1.3	2.5	3.8	6.0 ²⁾	6.0 ²⁾
20	<0.5 ¹⁾	0.6	1.3	2.4	3.6	6.0 ²⁾	6.0 ²⁾
25	<0.5 ¹⁾	0.6	1.2	2.3	3.3	5.8	6.0 ²⁾
32	<0.5 ¹⁾	0.6	1.1	2.1	3.0	5.5	6.0 ²⁾
40	<0.5 ¹⁾	0.6	1.0	2.0	2.8	4.9	6.0 ²⁾

Short-circuit selectivity **Characteristic C** towards fuse link **D01-D03***)

PLN6	D01-D03 gL/gG						
I_n [A]	20	25	35	50	63	80	100
2	1.1	2.0	6.0 ²⁾	6.0 ²⁾	6.0 ²⁾	6.0 ²⁾	6.0 ²⁾
4	0.6	0.9	2.7	6.0 ²⁾	6.0 ²⁾	6.0 ²⁾	6.0 ²⁾
6	0.6	0.9	2.3	5.0	6.0 ²⁾	6.0 ²⁾	6.0 ²⁾
10	0.5	0.7	1.5	3.0	4.5	6.0 ²⁾	6.0 ²⁾
13	0.5	0.7	1.3	2.7	4.0	6.0 ²⁾	6.0 ²⁾
16	<0.5 ¹⁾	0.6	1.1	2.2	3.1	5.5	6.0 ²⁾
20	<0.5 ¹⁾	0.6	1.1	2.1	2.9	5.2	6.0 ²⁾
25	<0.5 ¹⁾	0.5	1.0	2.0	2.7	4.8	6.0 ²⁾
32	<0.5 ¹⁾	0.5	1.0	1.9	2.6	4.5	6.0 ²⁾
40	<0.5 ¹⁾	0.5	0.9	1.7	2.3	4.0	6.0 ²⁾

Short-circuit selectivity **Characteristic B** towards fuse link **NH-00***)

PLN6	NH-00 gL/gG								
I_n [A]	20	25	32	35	40	50	63	80	100
6	0.5	0.9	1.5	2.3	3.2	4.9	6.0 ²⁾	6.0 ²⁾	6.0 ²⁾
10	<0.5 ¹⁾	0.7	1.2	1.5	2.0	3.1	3.9	5.9	6.0 ²⁾
13	<0.5 ¹⁾	0.6	1.0	1.3	1.7	2.5	3.1	4.6	6.0 ²⁾
16	<0.5 ¹⁾	0.6	1.0	1.3	1.6	2.4	2.9	4.5	6.0 ²⁾
20	<0.5 ¹⁾	0.5	0.9	1.3	1.5	2.3	2.8	4.3	6.0 ²⁾
25	<0.5 ¹⁾	0.5	0.9	1.1	1.4	2.1	2.6	4.0	6.0 ²⁾
32	<0.5 ¹⁾	0.5	0.8	1.0	1.3	1.9	2.4	3.6	6.0 ²⁾
40	<0.5 ¹⁾	0.5	0.8	0.9	1.1	1.7	2.2	3.3	6.0 ²⁾

Short-circuit selectivity **Characteristic C** towards fuse link **NH-00***)

PLN6	NH-00 gL/gG								
I_n [A]	20	25	32	35	40	50	63	80	100
2	0.7	2.1	6.0	6.0 ²⁾	6.0 ²⁾	6.0 ²⁾	6.0 ²⁾	6.0 ²⁾	6.0 ²⁾
4	0.5	0.9	1.6	2.6	3.7	6.0	6.0 ²⁾	6.0 ²⁾	6.0 ²⁾
6	0.5	0.8	1.4	2.1	2.9	4.5	5.7	6.0 ²⁾	6.0 ²⁾
10	<0.5 ¹⁾	0.6	1.0	1.4	1.9	2.8	3.5	5.2	6.0 ²⁾
13	<0.5 ¹⁾	0.6	0.9	1.3	1.7	2.5	3.1	4.7	6.0 ²⁾
16	<0.5 ¹⁾	0.5	0.7	1.0	1.3	2.0	2.5	3.8	6.0 ²⁾
20	<0.5 ¹⁾	0.5	0.7	0.9	1.2	1.8	2.3	3.5	6.0 ²⁾
25	<0.5 ¹⁾	0.5	0.7	0.9	1.1	1.6	2.1	3.3	6.0 ²⁾
32	<0.5 ¹⁾	<0.5 ¹⁾	0.6	0.8	1.1	1.5	2.0	3.1	6.0 ²⁾
40	<0.5 ¹⁾	<0.5 ¹⁾	0.6	0.8	1.0	1.4	1.9	2.9	6.0 ²⁾

¹⁾ Selectivity limit current I_s under 0.5 kA

²⁾ Selectivity limit current I_s = rated breaking capacity I_{cn} of the MCB

Load Capacity PLN4

Load capacity in case of MCB block installation

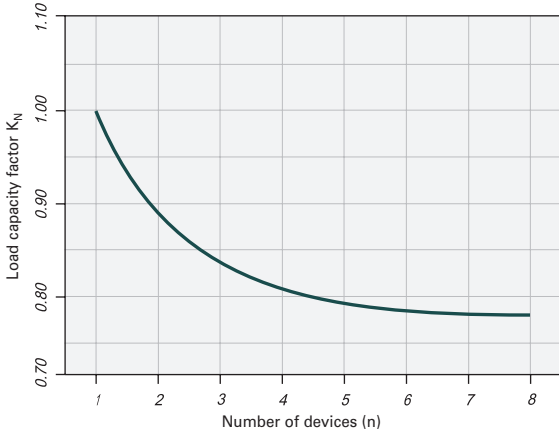

Current carrying capacity at ambient temperature ($I_n = 2-13 A$)

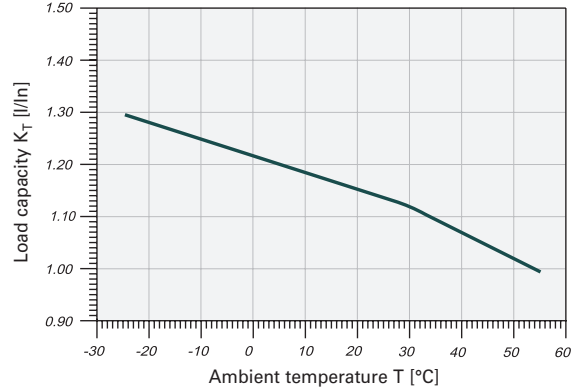

Current carrying capacity at ambient temperature ($I_n = 16-25 A$)

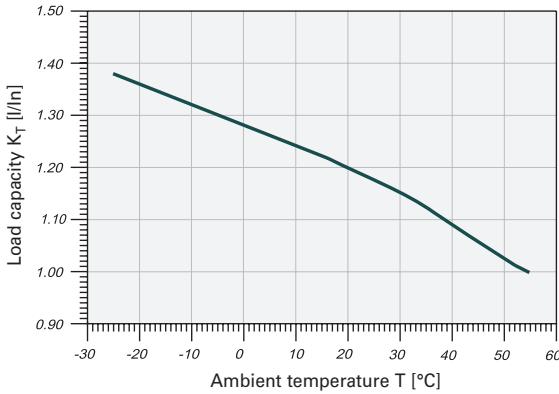

Current carrying capacity at ambient temperature ($I_n = 32, 40 A$)

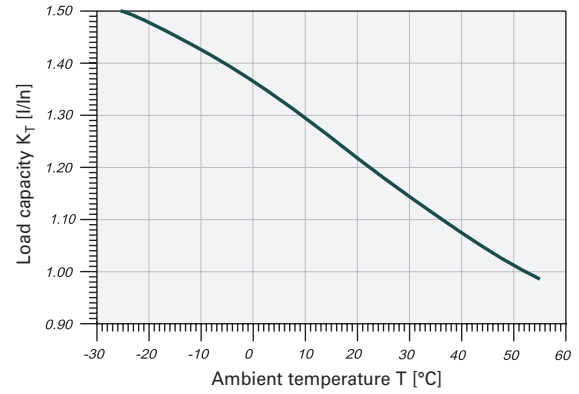

Permitted permanent load at ambient temperature T (°C) with n devices: $I_{DL} = I_n K_T(T) K_N(N)$.

Let-through Energy PLN4

Maximum let-through energy PLN4, Characteristic B

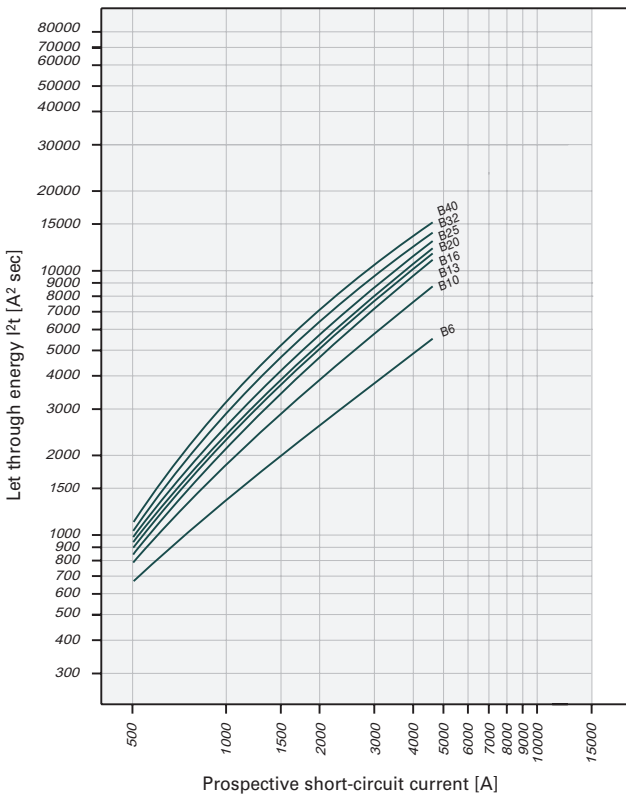

Maximum let-through energy PLN4, Characteristic C

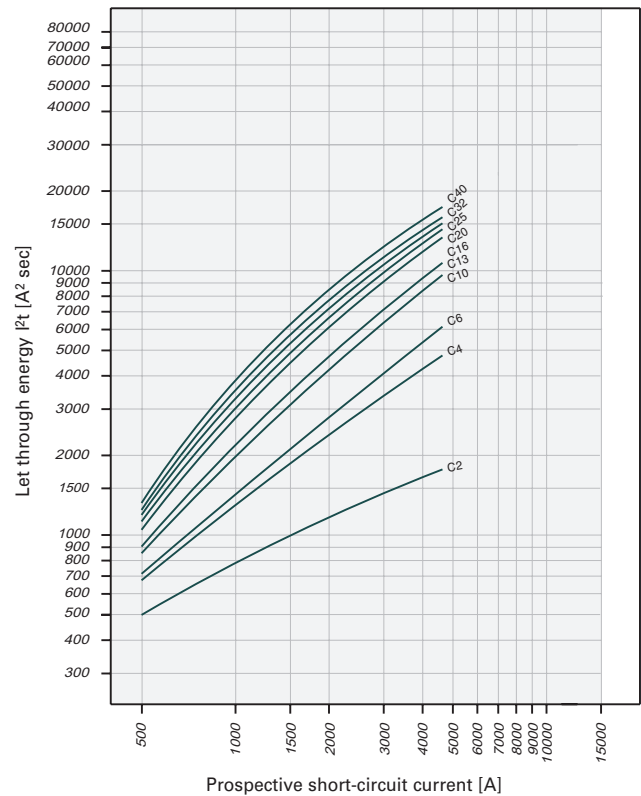

Determined according to 60898-1.

Short-circuit Selectivity PLN4

In case of short-circuit, there is selectivity between the miniature circuit breakers PLN4 and the upstream fuses up to the specified values of the selectivity limit current I_s [kA] (i. e. in case of short-circuit currents I_{ks} under I_s only the MCB will trip, in case of short-circuit currents above this value both protective devices will respond).

*) basically in accordance with EN 60898-1 D.5.2.b

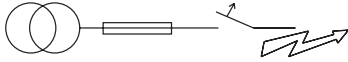

Short-circuit selectivity **Characteristic B** towards fuse link **DII-DIV***)

PLN4	DII-DIV gL/gG						
I_n [A]	20	25	35	50	63	80	100
6	0.7	1.2	2.9	4.5 ²⁾	4.5 ²⁾	4.5 ²⁾	4.5 ²⁾
10	0.6	0.9	1.9	3.1	4.5 ²⁾	4.5 ²⁾	4.5 ²⁾
13	0.5	0.7	1.5	2.5	4.5 ²⁾	4.5 ²⁾	4.5 ²⁾
16	0.5	0.7	1.4	2.3	4.3	4.5 ²⁾	4.5 ²⁾
20	0.5	0.7	1.4	2.2	4.0	4.5 ²⁾	4.5 ²⁾
25	0.5	0.6	1.3	2.0	3.8	4.5 ²⁾	4.5 ²⁾
32	0.5	0.6	1.2	1.8	3.4	4.5 ²⁾	4.5 ²⁾
40	<0.5 ¹⁾	0.6	1.1	1.7	3.1	4.5 ²⁾	4.5 ²⁾

Short-circuit selectivity **Characteristic C** towards fuse link **DII-DIV***)

PLN4	DII-DIV gL/gG						
I_n [A]	20	25	35	50	63	80	100
2	1.5	3.8	4.5 ²⁾	4.5 ²⁾	4.5 ²⁾	4.5 ²⁾	4.5 ²⁾
4	0.7	1.2	3.3	4.5 ²⁾	4.5 ²⁾	4.5 ²⁾	4.5 ²⁾
6	0.7	1.1	2.6	4.5 ²⁾	4.5 ²⁾	4.5 ²⁾	4.5 ²⁾
10	0.5	0.8	1.7	2.8	4.5 ²⁾	4.5 ²⁾	4.5 ²⁾
13	0.5	0.7	1.5	2.5	4.5 ²⁾	4.5 ²⁾	4.5 ²⁾
16	0.5	0.6	1.2	2.0	3.6	4.5 ²⁾	4.5 ²⁾
20	0.5	0.6	1.2	1.8	3.3	4.5 ²⁾	4.5 ²⁾
25	<0.5 ¹⁾	0.6	1.1	1.7	3.0	4.5 ²⁾	4.5 ²⁾
32	<0.5 ¹⁾	0.6	1.0	1.6	2.8	4.5 ²⁾	4.5 ²⁾
40	<0.5 ¹⁾	0.6	1.0	1.5	2.6	4.0	4.5 ²⁾

Short-circuit selectivity **Characteristic B** towards fuse link **D01-D03***)

PLN4	D01-D03 gL/gG						
I_n [A]	20	25	35	50	63	80	100
6	0.6	0.9	2.5	4.5 ²⁾	4.5 ²⁾	4.5 ²⁾	4.5 ²⁾
10	0.5	0.8	1.6	3.4	4.5 ²⁾	4.5 ²⁾	4.5 ²⁾
13	0.5	0.7	1.3	2.7	4.0	4.5 ²⁾	4.5 ²⁾
16	0.5	0.6	1.3	2.5	3.8	4.5 ²⁾	4.5 ²⁾
20	<0.5 ¹⁾	0.6	1.3	2.4	3.6	4.5 ²⁾	4.5 ²⁾
25	<0.5 ¹⁾	0.6	1.2	2.3	3.3	4.5 ²⁾	4.5 ²⁾
32	<0.5 ¹⁾	0.6	1.1	2.1	3.0	4.5 ²⁾	4.5 ²⁾
40	<0.5 ¹⁾	0.6	1.0	2.0	2.8	4.5 ²⁾	4.5 ²⁾

Short-circuit selectivity **Characteristic C** towards fuse link **D01-D03***)

PLN4	D01-D03 gL/gG						
I_n [A]	20	25	35	50	63	80	100
2	1.1	2.0	4.5 ²⁾	4.5 ²⁾	4.5 ²⁾	4.5 ²⁾	4.5 ²⁾
4	0.6	0.9	2.7	4.5 ²⁾	4.5 ²⁾	4.5 ²⁾	4.5 ²⁾
6	0.6	0.9	2.3	4.5 ²⁾	4.5 ²⁾	4.5 ²⁾	4.5 ²⁾
10	0.5	0.7	1.5	3.0	4.5 ²⁾	4.5 ²⁾	4.5 ²⁾
13	0.5	0.7	1.3	2.7	4.0	4.5 ²⁾	4.5 ²⁾
16	<0.5 ¹⁾	0.6	1.1	2.2	3.1	4.5 ²⁾	4.5 ²⁾
20	<0.5 ¹⁾	0.6	1.1	2.1	2.9	4.5 ²⁾	4.5 ²⁾
25	<0.5 ¹⁾	0.5	1.0	2.0	2.7	4.5 ²⁾	4.5 ²⁾
32	<0.5 ¹⁾	0.5	1.0	1.9	2.6	4.5 ²⁾	4.5 ²⁾
40	<0.5 ¹⁾	0.5	0.9	1.7	2.3	4.0	4.5 ²⁾

Short-circuit selectivity **Characteristic B** towards fuse link **NH-00***)

PLN4	NH-00 gL/gG								
I_n [A]	20	25	32	35	40	50	63	80	100
6	0.5	0.9	1.5	2.3	3.2	4.5 ²⁾	4.5 ²⁾	4.5 ²⁾	4.5 ²⁾
10	<0.5 ¹⁾	0.7	1.2	1.5	2.0	3.1	3.9	4.5 ²⁾	4.5 ²⁾
13	<0.5 ¹⁾	0.6	1.0	1.3	1.7	2.5	3.1	4.5 ²⁾	4.5 ²⁾
16	<0.5 ¹⁾	0.6	1.0	1.3	1.6	2.4	2.9	4.5 ²⁾	4.5 ²⁾
20	<0.5 ¹⁾	0.5	0.9	1.3	1.5	2.3	2.8	4.3	4.5 ²⁾
25	<0.5 ¹⁾	0.5	0.9	1.1	1.4	2.1	2.6	4.0	4.5 ²⁾
32	<0.5 ¹⁾	0.5	0.8	1.0	1.3	1.9	2.4	3.6	4.5 ²⁾
40	<0.5 ¹⁾	0.5	0.8	0.9	1.1	1.7	2.2	3.3	4.5 ²⁾

Short-circuit selectivity **Characteristic C** towards fuse link **NH-00***)

PLN4	NH-00 gL/gG								
I_n [A]	20	25	32	35	40	50	63	80	100
2	0.7	2.1	4.5 ²⁾	4.5 ²⁾	4.5 ²⁾	4.5 ²⁾	4.5 ²⁾	4.5 ²⁾	4.5 ²⁾
4	0.5	0.9	1.6	2.6	3.7	4.5 ²⁾	4.5 ²⁾	4.5 ²⁾	4.5 ²⁾
6	0.5	0.8	1.4	2.1	2.9	4.5 ²⁾	4.5 ²⁾	4.5 ²⁾	4.5 ²⁾
10	<0.5 ¹⁾	0.6	1.0	1.4	1.9	2.8	3.5	4.5 ²⁾	4.5 ²⁾
13	<0.5 ¹⁾	0.6	0.9	1.3	1.7	2.5	3.1	4.5 ²⁾	4.5 ²⁾
16	<0.5 ¹⁾	0.5	0.7	1.0	1.3	2.0	2.5	3.8	4.5 ²⁾
20	<0.5 ¹⁾	0.5	0.7	0.9	1.2	1.8	2.3	3.5	4.5 ²⁾
25	<0.5 ¹⁾	0.5	0.7	0.9	1.1	1.6	2.1	3.3	4.5 ²⁾
32	<0.5 ¹⁾	<0.5 ¹⁾	0.6	0.8	1.1	1.5	2.0	3.1	4.5 ²⁾
40	<0.5 ¹⁾	<0.5 ¹⁾	0.6	0.8	1.0	1.4	1.9	2.9	4.5 ²⁾

¹⁾ Selectivity limit current I_s under 0.5 kA

²⁾ Selectivity limit current I_s = rated breaking capacity I_{cn} of the MCB

SG43611



Description

- High-quality miniature circuit breakers for commercial and industrial applications
- Contact position indicator red - green
- Accessories suitable for subsequent installation
- Rated currents up to 125 A
- Tripping characteristics B, C, D
- Rated breaking capacity up to 25 kA according to EN 60947-2

1.5

Miniature Circuit Breakers (MCBs)

xPole

Miniature Circuit Breakers PLHT

Rated current I_n (A)	Type Designation	Article No.	Units per package
----------------------------	---------------------	-------------	----------------------

25 kA, Characteristic B

SG41311



1-pole

20	PLHT-B20	247972	12
25	PLHT-B25	247973	12
32	PLHT-B32	247974	12
40	PLHT-B40	247975	12
50	PLHT-B50	247976	12
63	PLHT-B63	247977	12
80	PLHT-B80	247978	12
100	PLHT-B100	247979	12
125	PLHT-B125	247980	12

SG42111



2-pole

20	PLHT-B20/2	247998	6
25	PLHT-B25/2	247999	6
32	PLHT-B32/2	248000	6
40	PLHT-B40/2	248001	6
50	PLHT-B50/2	248002	6
63	PLHT-B63/2	248003	6
80	PLHT-B80/2	248004	6
100	PLHT-B100/2	248005	6
125	PLHT-B125/2	248006	6

SG42911



3-pole

20	PLHT-B20/3	248024	4
25	PLHT-B25/3	248025	4
32	PLHT-B32/3	248026	4
40	PLHT-B40/3	248027	4
50	PLHT-B50/3	248028	4
63	PLHT-B63/3	248029	4
80	PLHT-B80/3	248030	4
100	PLHT-B100/3	248031	4
125	PLHT-B125/3	248032	4

SG45111



3+N-pole

20	PLHT-B20/3N	248050	3
25	PLHT-B25/3N	248051	3
32	PLHT-B32/3N	248052	3
40	PLHT-B40/3N	248053	3
50	PLHT-B50/3N	248054	3
63	PLHT-B63/3N	248055	3
80	PLHT-B80/3N	248056	3
100	PLHT-B100/3N	248057	3
125	PLHT-B125/3N	248058	3

SG44811



4-pole

20	PLHT-B20/4	248076	3
25	PLHT-B25/4	248077	3
32	PLHT-B32/4	248078	3
40	PLHT-B40/4	248079	3
50	PLHT-B50/4	248080	3
63	PLHT-B63/4	248081	3
80	PLHT-B80/4	248082	3
100	PLHT-B100/4	248083	3
125	PLHT-B125/4	248084	3

Explanation PLHT:

P = xPole, LH = Miniature Circuit Breakers hochwertig, T = Rated breaking capacity 15, 20, 25 kA

Rated current I_n (A)	Type Designation	Article No.	Units per package
----------------------------	---------------------	-------------	----------------------

25 kA, Characteristic C

SG41311



1-pole

20	PLHT-C20	247981	12
25	PLHT-C25	247982	12
32	PLHT-C32	247983	12
40	PLHT-C40	247984	12
50	PLHT-C50	247985	12
63	PLHT-C63	247986	12
80	PLHT-C80	247987	12
100	PLHT-C100	247988	12
125	PLHT-C125	247989	12

SG42111



2-pole

20	PLHT-C20/2	248007	6
25	PLHT-C25/2	248008	6
32	PLHT-C32/2	248009	6
40	PLHT-C40/2	248010	6
50	PLHT-C50/2	248011	6
63	PLHT-C63/2	248012	6
80	PLHT-C80/2	248013	6
100	PLHT-C100/2	248014	6
125	PLHT-C125/2	248015	6

SG42911



3-pole

20	PLHT-C20/3	248033	4
25	PLHT-C25/3	248034	4
32	PLHT-C32/3	248035	4
40	PLHT-C40/3	248036	4
50	PLHT-C50/3	248037	4
63	PLHT-C63/3	248038	4
80	PLHT-C80/3	248039	4
100	PLHT-C100/3	248040	4
125	PLHT-C125/3	248041	4

SG45111



3+N-pole

20	PLHT-C20/3N	248059	3
25	PLHT-C25/3N	248060	3
32	PLHT-C32/3N	248061	3
40	PLHT-C40/3N	248062	3
50	PLHT-C50/3N	248063	3
63	PLHT-C63/3N	248064	3
80	PLHT-C80/3N	248065	3
100	PLHT-C100/3N	248066	3
125	PLHT-C125/3N	248067	3

SG44811



4-pole

20	PLHT-C20/4	248085	3
25	PLHT-C25/4	248086	3
32	PLHT-C32/4	248087	3
40	PLHT-C40/4	248088	3
50	PLHT-C50/4	248089	3
63	PLHT-C63/4	248090	3
80	PLHT-C80/4	248091	3
100	PLHT-C100/4	248092	3
125	PLHT-C125/4	248093	3

1.5

Miniature Circuit Breakers (MCBs)

xPole

Miniature Circuit Breakers PLHT

Rated current I_n (A)	Type Designation	Article No.	Units per package
----------------------------	---------------------	-------------	----------------------

25 kA, Characteristic D

SG41311



1-pole

20	PLHT-D20	247990	12
25	PLHT-D25	247991	12
32	PLHT-D32	247992	12
40	PLHT-D40	247993	12
50	PLHT-D50	247994	12
63	PLHT-D63	247995	12
80	PLHT-D80	247996	12
100	PLHT-D100	247997	12

SG42111



2-pole

20	PLHT-D20/2	248016	6
25	PLHT-D25/2	248017	6
32	PLHT-D32/2	248018	6
40	PLHT-D40/2	248019	6
50	PLHT-D50/2	248020	6
63	PLHT-D63/2	248021	6
80	PLHT-D80/2	248022	6
100	PLHT-D100/2	248023	6

SG42911



3-pole

20	PLHT-D20/3	248042	4
25	PLHT-D25/3	248043	4
32	PLHT-D32/3	248044	4
40	PLHT-D40/3	248045	4
50	PLHT-D50/3	248046	4
63	PLHT-D63/3	248047	4
80	PLHT-D80/3	248048	4
100	PLHT-D100/3	248049	4

SG45111



3+N-pole

20	PLHT-D20/3N	248068	3
25	PLHT-D25/3N	248069	3
32	PLHT-D32/3N	248070	3
40	PLHT-D40/3N	248071	3
50	PLHT-D50/3N	248072	3
63	PLHT-D63/3N	248073	3
80	PLHT-D80/3N	248074	3
100	PLHT-D100/3N	248075	3

SG44811



4-pole

20	PLHT-D20/4	248094	3
25	PLHT-D25/4	248095	3
32	PLHT-D32/4	248096	3
40	PLHT-D40/4	248097	3
50	PLHT-D50/4	248098	3
63	PLHT-D63/4	248099	3
80	PLHT-D80/4	248100	3
100	PLHT-D100/4	248101	3

Explanation PLHT:

P = xPole, LH = Miniature Circuit Breakers hochwertig, T = Rated breaking capacity 15, 20, 25 kA

Rated current I_n (A)	Type Designation	Article No.	Units per package
----------------------------	---------------------	-------------	----------------------

Miniature Circuit Breakers PLHT-V, 25 kA, similar to characteristic D

SG69611



1-pole

20	PLHT-20-V	248102	12
25	PLHT-25-V	248103	12
32	PLHT-32-V	248104	12
40	PLHT-40-V	248105	12
50	PLHT-50-V	248106	12
63	PLHT-63-V	248107	12

Accessories for Miniature Circuit Breakers PLHT, PLHT-V

Shunt trip release, Shunt trip release-Kit

SG09311



Operational voltage range V~	Type Designation	Article No.	Units per package
110-415 / Shunt trip release	Z-LHASA/230	248442	8
12-60 / Shunt trip release	Z-LHASA/24	248441	8
110-415 / Shunt trip release-Kit	Z-BHASA/230	248445	8
12-60 / Shunt trip release-Kit	Z-BHASA/24	248444	8

Auxiliary switch

SG16111



Function	Type Designation	Article No.	Units per package
1NO+1NC	Z-LHK	248440	10/100

Accessories for Miniature Circuit Breakers PLHT-V

Switching interlock, Busbar block

wa_sg11402

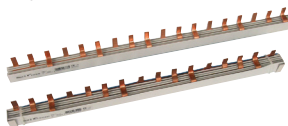

Benennung	Type Designation	Article No.	Units per package
Switching interlock	LH-SPL	285752	1
Switching interlock	LHSP-E	215999	1
Switchoff interlock	LHSP-A	216000	1
Busbar block 35 mm ²	Z-SV-35/PLHT-V	264939	4

Specifications | Miniature Circuit Breakers PLHT

Description

- Independent switching contacts
- With isolator function, meets the requirements of insulation co-ordination, distance between contacts ≥ 4 mm, for secure isolation

Accessories:

Auxiliary switch for subsequent installation (0.5 MU)	Z-LHK	248440
Shunt trip release subsequent installation (1.5 MU)	Z-LHASA/230	248442
	Z-LHASA/24	248441
Switching interlock	LH-SPL	285752

Busbars:

see chapter busbar systems

Technical Data

		PLHT
Electrical		
Design according to		EN 60947-2
Current test marks as printed onto the device		
Rated voltage	U_n	AC: 230/400 V DC: 60 V (per pole, max. 2 poles)
Ultimate short-circuit breaking capacity according to IEC/EN 60947-2		
Characteristic B, C		$I_n = 20-63$ A: 25 kA $I_n = 80-100$ A: 20 kA $I_n = 125$ A: 15 kA
Characteristic D		$I_n = 20-63$ A: 25 kA $I_n = 80$ A: 20 kA $I_n = 100$ A: 15 kA
Characteristic		in accordance with B, C, D
Back-up fuse		max. 200 A gL
Rated insulation voltage		440 V
Peak withstand voltage	U_{imp}	4 kV
Selectivity class		in accordance with class 3
Endurance		$\geq 20,000$ switching operations
Mechanical		
Frame size		45 mm
Device height		90 mm
Device width		27 mm (1.5MU) per pole
Mounting		quick fastening with 2 lock-in positions on DIN rail IEC/EN 60715
Degree of protection		IP20
Degree of protection, built-in		IP40
Upper and lower terminals		lift terminals
Terminal protection		finger and hand touch safe, DGUV VS3, EN 50274
Terminal capacity		2.5-50 mm ²

Connection diagrams

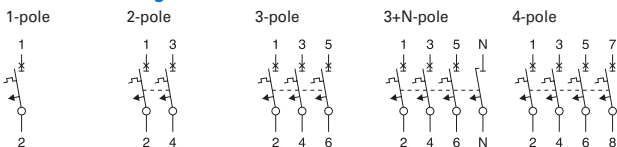

Dimensions (mm)

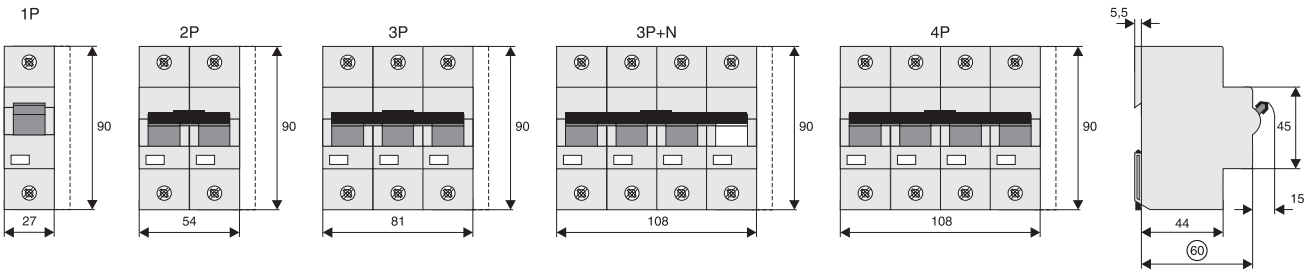

Load Capacity

Load capacity in case of block installation

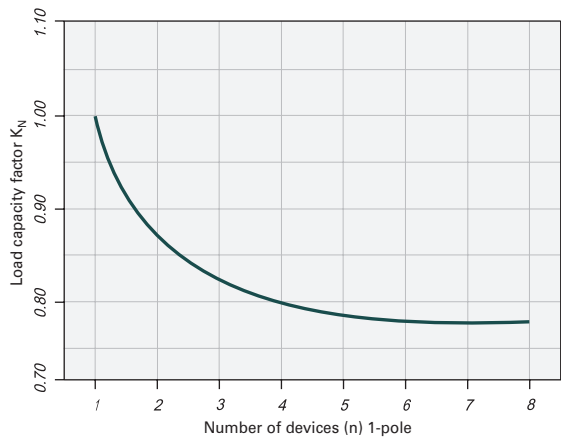

Effect of ambient temperature

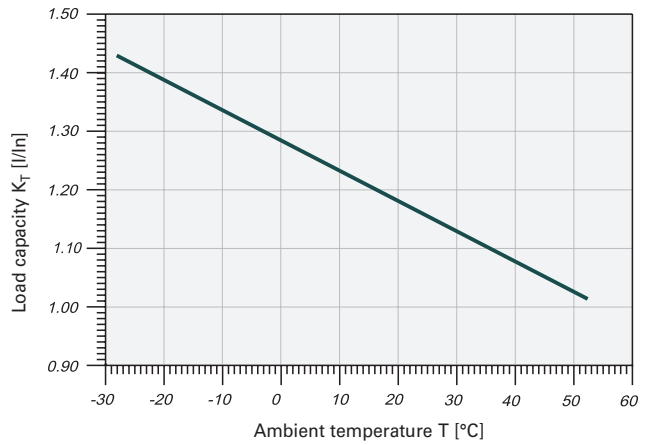

Permitted permanent load at ambient temperature T [°C] with n devices: $I_{DL} = I_n K_T(T) K_N(N)$.

Durchlassenergie

Maximum let-through energy PLHT, Characteristic C, 1-pole

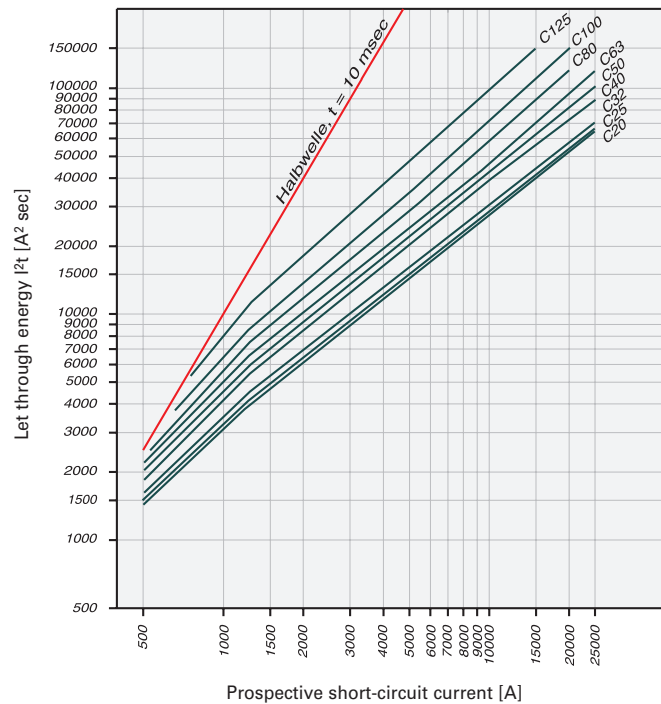

Maximum let-through energy PLHT, Characteristic D, 1-pole

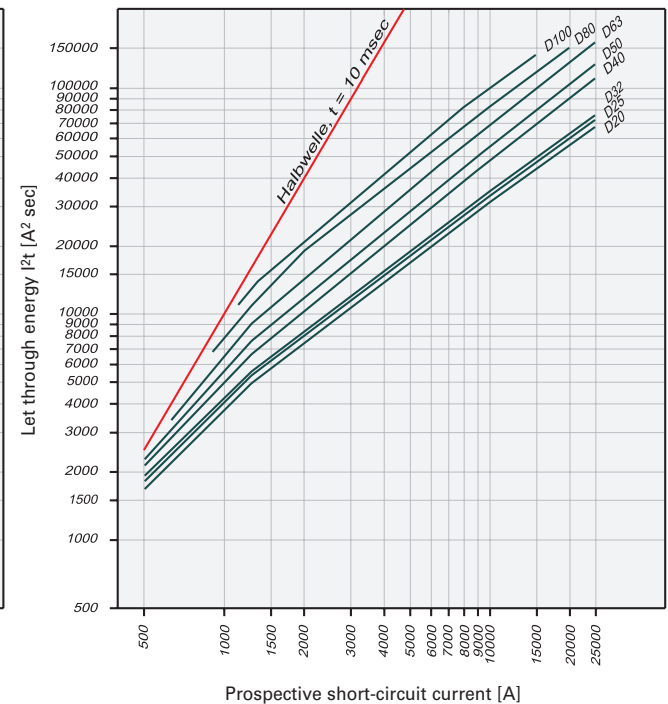

Determined according to 60898-1.

Short-circuit Selectivity PLHT towards D01, D02, D03 and NH size 00

- Short-circuit selectivity (in kA) PLHT and upstream fuse D0 or NH, operating class gL/gG
- 1.4 . . . selectivity up to 1.4 kA; Darker areas: no selectivity

Selectivity towards back-up fuses D01, D02, D03

Characteristic C

PLHT I _n [A]	Rated current of the back-up fuse in A gL/gG					
	25	35	50	63	80	100
20	0.5	1.0	2.0	2.9	3.9	7.6
25		1.0	1.9	2.8	3.8	7.3
32		1.0	1.8	2.7	3.6	7.0
40			1.6	2.2	3.0	5.6
50				2.1	2.8	5.2
63					2.7	4.8
80						4.3
100						
125						

Characteristic D

PLHT I _n [A]	Rated current of the back-up fuse in A gL/gG					
	25	35	50	63	80	100
20	0.5	0.9	1.7	2.5	3.4	6.7
25		0.9	1.6	2.3	3.2	6.2
32		0.9	1.5	2.3	3.0	6.0
40			1.4	2.0	2.6	4.7
50				1.8	2.3	4.3
63					2.1	3.7
80						3.1
100						

Selectivity towards back-up fuses NH size 00

Characteristic C

PLHT I _n [A]	Rated current of the back-up fuse in A gL/gG									
	25	35	40	50	63	80	100	125	160	200
20	0.5	1.0	1.3	1.9	2.7	3.7	6.7	17.0	25.0	25.0
25		0.9	1.3	1.8	2.6	3.5	6.5	17.0	25.0	25.0
32		0.9	1.2	1.7	2.4	3.3	6.0	15.0	23.0	25.0
40				1.4	2.1	2.9	4.8	12.0	18.0	25.0
50					1.9	2.7	4.5	11.0	17.0	25.0
63							4.2	10.0	15.0	25.0
80							3.8	8.5	12.0	25.0
100								7.0	10.0	25.0
125									7.5	25.0

Characteristic D

PLHT I _n [A]	Rated current of the back-up fuse in A gL/gG									
	25	35	40	50	63	80	100	125	160	200
20	<0.5	0.8	1.1	1.5	2.3	3.1	5.6	16.0	25.0	25.0
25		0.7	1.0	1.4	2.1	3.0	5.3	14.0	23.0	25.0
32		0.7	1.0	1.3	2.1	2.9	5.0	13.0	22.0	25.0
40				1.1	1.8	2.5	4.2	10.0	15.0	25.0
50					1.6	2.3	3.8	8.5	13.0	22.0
63						2.1	3.2	7.0	10.5	18.0
80							2.8	5.5	8.4	15.0
100								4.8	7.5	12.5

Short-circuit Selectivity PLHT towards NZM

In case of short-circuit, there is selectivity between the miniature circuit breakers PLHT and the upstream NZM up to the specified values of the selectivity limit current I_s [kA] (i. e. in case of short-circuit currents I_{ks} under I_s only the MCB will trip, in case of short-circuit currents above this value both protective devices will respond). Overload and short-circuit release unit NZM at max. value.

*) basically in accordance with EN 60898-1 D.5.2.b

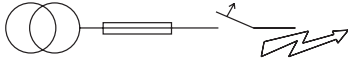

Short-circuit selectivity **Characteristic C** towards **NZM1***)

PLHT	NZM...1-A gL/gG					
I_n [A]	40	50	63	80	100	125
20	0.3	0.4	0.5	0.75	0.9	1.25
25	0.3	0.4	0.5	0.7	0.9	1.2
32		0.4	0.5	0.7	0.85	1.2
40			0.5	0.6	0.85	1.1
50				0.6	0.85	1.1
63					0.8	1
80						1
100						
125						

Short-circuit selectivity **Characteristic D** towards **NZM1***)

PLHT	NZM...1-A gL/gG					
I_n [A]	40	50	63	80	100	125
50						
63						
80						
100						

Short-circuit selectivity **Characteristic C** towards **NZM2***)

PLHT	NZM...2-A gL/gG								
I_n [A]	40	50	63	80	100	125	160	200	250
20	0.3	0.4	0.5	0.75	0.9	1.25	1.8	2.5	3.5
25	0.3	0.4	0.5	0.7	0.9	1.2	1.7	2.4	3.3
32		0.4	0.5	0.7	0.85	1.2	1.65	2.3	3.2
40			0.5	0.6	0.85	1.1	1.5	2.1	2.9
50				0.6	0.85	1.1	1.5	2	2.8
63					0.8	1	1.4	1.8	2.5
80						1	1.4	1.8	2.4
100							1.3	1.7	2.3
125								1.6	2.1

Short-circuit selectivity **Characteristic D** towards **NZM2***)

PLHT	NZM...2-A gL/gG									
I_n [A]	40	50	63	80	100	125	160	200	250	
50								1	1.4	2.6
63								1	1.3	2.3
80										2.1
100										

1) Selectivity limit current I_s under 0.5 kA

2) Selectivity limit current I_s = rated breaking capacity I_{cn} of the MCB

Darker areas: no selectivity

Specifications | Miniature Circuit Breakers PLHT-V

Description

- Special type of miniature circuit breaker PLHT for trade and industry applications upstream of the meter
- Independent switching contacts
- High current limit
- With isolator function, meets the requirements of insulation co-ordination, distance between contacts ≥ 4 mm, for secure isolation
- Anti-Tamper device and Switchoff interlock available

Accessories:

Auxiliary switch for subsequent installation (0.5 MU)	Z-LHK	248440
Shunt trip release subsequent installation (1.5 MU)	Z-LHASA/230	248442
	Z-LHASA/24	248441

Busbars:

see capter busbar systems

Technical Data

		PLHT-V
Electrical		
Design according to		EN 60947-2
Current test marks as printed onto the device		
Rated voltage	U_n	AC: 230/400 V DC: 60 V (per pole, max. 2 poles)
Ultimate short-circuit breaking capacity according to IEC/EN 60947-2		25 kA
Service short-circuit breaking capacity		20 kA
Rated breaking capacity		DC: max. 60 V, 1-pole
Characteristic		similar to D
Back-up fuse		max. 200 A gL (>20 kA)
Rated insulation voltage		440 V
Peak withstand voltage	U_{imp}	4 kV
Selectivity class		in accordance with class 3
Endurance		$\geq 20,000$ switching operations
Mechanical		
Frame size		45 mm
Device height		90 mm
Device width		27 mm (1.5MU) per pole, 30 mm per pole PLHT-V with interlock
Mounting		quick fastening with 2 lock-in positions on DIN rail IEC/EN 60715
Degree of protection		IP20
Degree of protection, built-in		IP40
Upper and lower terminals		lift terminals
Terminal protection		finger and hand touch safe, DGUV VS3, EN 50274
Terminal capacity		2.5-50 mm ²

Connection diagram

1-pole



Dimensions (mm)

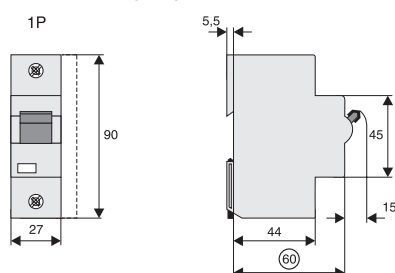

Specifications | Accessories for PLHT, PLHT-V

Shunt trip release Z-LHASA

- Can be mounted subsequently
- Contact position indicator red/green
- Marking labels can be fitted
- Wide operational voltage range
- Sufficient power of extra low voltage source must be ensured
Z-LHASA/24: min. 90 VA

Technical Data

	Z-LHASA
Electrical	
Operational voltage range	
Z-LHASA/230	110-415 V~
Z-LHASA/24	12-60 V~
Operational frequency	50-60 Hz
Maximum current consumption during switch-on at U_n	
Z-LHASA/230	2 A
Z-LHASA/24	18 A
Mechanical	
Frame size	45 mm
Device height	90 mm
Device width	27 mm
Mounting	quick fastening with 2 lock-in positions on DIN rail IEC/EN 60715
Degree of protection	IP20
Degree of protection, built-in	IP40
Upper and lower terminals	lift terminals

Dimensions (mm)

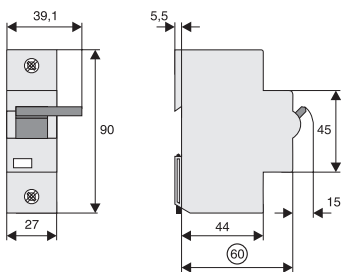

Auxiliary switch Z-LHK

- Auxiliary switch according to IEC 947-5-1
- Can be mounted subsequently

Technical Data

	Z-LHK
Electrical	
Rated operational current	(250 V~) 6 A / AC13
Minimum operational voltage	24 V each line
Rated thermal current	8 A
Rated insulation voltage	440 V~
Maximum back-up fuse	6 A gL
Contacts	1NO+1NC
Utilisation category AC13	6 A / 250 VAC 2 A / 440 VAC
Utilisation category DC13	4 A / 60 VDC 2 A / 110 VDC 0,5 A / 230 VDC
Mechanical	
Frame size	45 mm
Device height	90 mm
Device width	9 mm
Mounting	mounted onto protective devices
Degree of protection, built-in	IP40
Upper and lower terminals	lift terminals
Terminal capacity	1 x 1 mm ² to 2 x 2.5 mm ²

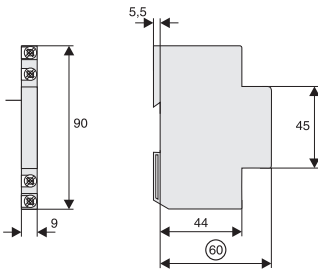
Connection diagram**Dimensions (mm)**

Specifications | Accessories for PLHT-V

Switching interlock LHSP-E, LH-SPL

- Prevents undesired switching ON or OFF

Switchoff interlock LHSP-A

- Prevents undesired switch-OFF

Busbar block 35 mm² Z-SV-35/PLHT-V, 3-pole (see chapter busbar systems)

- 110/220 A
- Step distance 30 mm

Dimensions (mm)

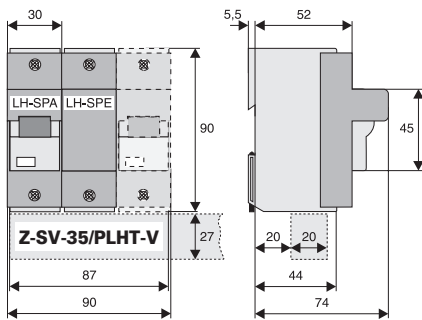

1.6

Adjustable MCB, Power Limiter

xPole

Adjustable MCB, Power Limiter, Motor-protective Circuit-breaker

SG09811

SG09711

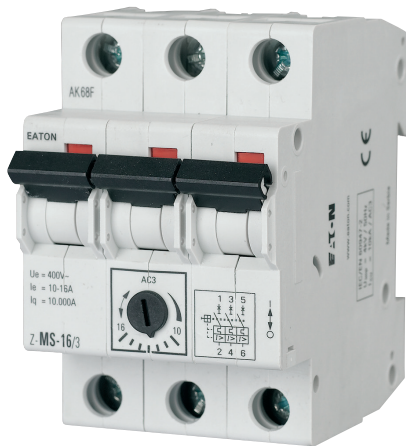

Setting Range (A)	Type Designation	Article No.	Units per package
-------------------	------------------	-------------	-------------------

Adjustable MCB Z-MS

SG09911



2-pole

0.10 - 0.16	Z-MS-0.16/2	248389	1/60
0.16 - 0.25	Z-MS-0,25/2	248390	1/60
0.25 - 0.40	Z-MS-0,4/2	248391	1/60
0.40 - 0.63	Z-MS-0,63/2	248392	1/60
0.63 - 1.00	Z-MS-1/2	248393	1/60
1.00 - 1.60	Z-MS-1,6/2	248394	1/60
1.60 - 2.50	Z-MS-2,5/2	248395	1/60
2.50 - 4.00	Z-MS-4/2	248396	1/60
4.00 - 6.30	Z-MS-6,3/2	248397	1/60
6.30 - 10.0	Z-MS-10/2	248398	1/60
10.0 - 16.0	Z-MS-16/2	248399	1/60
16.0 - 25.0	Z-MS-25/2	248400	1/60
25.0 - 40.0	Z-MS-40/2	248401	1/60

SG09811



3-pole

0.10 - 0.16	Z-MS-0.16/3	248402	1/40
0.16 - 0.25	Z-MS-0,25/3	248403	1/40
0.25 - 0.40	Z-MS-0,4/3	248404	1/40
0.40 - 0.63	Z-MS-0,63/3	248405	1/40
0.63 - 1.00	Z-MS-1/3	248406	1/40
1.00 - 1.60	Z-MS-1,6/3	248407	1/40
1.60 - 2.50	Z-MS-2,5/3	248408	1/40
2.50 - 4.00	Z-MS-4/3	248409	1/40
4.00 - 6.30	Z-MS-6,3/3	248410	1/40
6.30 - 10.0	Z-MS-10/3	248411	1/40
10.0 - 16.0	Z-MS-16/3	248412	1/40
16.0 - 25.0	Z-MS-25/3	248413	1/40
25.0 - 40.0	Z-MS-40/3	248414	1/40

Rated Current I _n (A)	Setting Range (A)	Type Designation	Article No.	Units per package
----------------------------------	-------------------	------------------	-------------	-------------------

Power Limiter Z-TS

SG09611



1-pole, 230 V~

20	13-20	Z-TS20/1	266850	2
25	16-25	Z-TS25/1	266852	2
32	20-32	Z-TS32/1	266853	2
40	25-40	Z-TS40/1	266854	2
50	40-50	Z-TS50/1	266855	2
63	50-63	Z-TS63/1	266856	2

SG09711



3-pole, 400 V~

20	13-20	Z-TS20/3	266857	1
25	16-25	Z-TS25/3	266858	1
32	20-32	Z-TS32/3	266859	1
40	25-40	Z-TS40/3	266860	1
50	40-50	Z-TS50/3	266861	1
63	50-63	Z-TS63/3	266862	1

Accessories for Adjustable MCB and Power Limiter

Function	Type Designation	Article No.	Units per package
Shunt trip release 24 V	ZP-ASA/24	248438	6/60
Shunt trip release 230 V	ZP-ASA/230	248439	6/60
Undervoltage release 115 V	Z-USA/115	248288	6/60
Undervoltage release 230 V	Z-USA/230	248289	6/60
Undervoltage release 400 V	Z-USA/400	248290	6/60
Undervoltage release, delayed 115 V	Z-USD/115	248292	6/60
Undervoltage release, delayed 230 V	Z-USD/230	248291	6/60
Auxiliary switch	ZP-IHK	286052	4/120
Tripping signal switch	ZP-NHK	248437	4/120
Remote control and automatic switching device	Z-FW-LP	248296	1/20
Additional terminal 35 mm ²	BB-UL-TEPA/35	169823	12/720

Moisture-proof enclosure Z-MFG, IP54

SG82111



ON/OFF	Z-MFG	248383	1
ON/OFF N-conductor	Z-MFG/NL	248384	1
ON/OFF with EMERGENCY OFF	Z-MFG/NOT	248385	1

Specifications | Adjustable MCB Z-MS

Description

- Reliable protection in case of thermal overload and short-circuit
- Suitable for installation in compact distribution boxes
- Contact position indicator red - green
- Main field of application: switching and protection of three-phase AC motors with power ratings up to 15 kW (380/400 V) and other consumers up to 40 A
- Also suitable as main switch, isolating characteristics according to IEC/EN 60947
- All manual motor starters with thermal overload tripping and magnetic short-circuit tripping
- Terminals and accessories compatible with Z-A40, PFIM etc.

Technical Data

		Z-MS
General		
Terminal capacity		1 - 25 mm ²
Busbar thickness		0.8-2 mm
Endurance mechanical components		20,000 switching operations
Shock resistance (shock duration 20 ms)		20 g
Ambient temperature		
open		-25 ... + 50 °C
hermetically enclosed		-25 ... + 40 °C
Resistance to climatic conditions		
humidity and heat, constant, according to		IEC 68-2-3
humidity and heat, periodical, according to		IEC 68-2-30
Weight approx.		
2-pole		244 g
3-pole		366 g
Degree of protection		IP20
Main Current Paths		
Rated insulation voltage	U_i	440 V
Rated impulse withstand voltage	U_{imp}	4 kV
Rated short-circuit breaking capacity	I_g	10 kA
Thermal current $I_{th\ max} = I_{e\ max}$		40 A
Electrical endurance AC3 and I_g		6,000 switching operations
Motor switching capacity AC3		400 (415) V
Power loss per contact		
1.6-10 A		2.3 W
16 A		3.3 W
25-40 A		4.5 W
Operating frequency		50/60 Hz
Auxiliary switch Z-AHK/Z-NHK		
Rated insulation voltage	U_i	440 V
Thermal current	I_{th}	8 A
Rated operational current	I_e	
250 V		6 A
with AC 13, 440 V		2 A
Max. back-up fuse for short-circuit protection		4 A (gL, gG) CLS6-4/B-HS
Terminal capacity (1 or 2 conductors)		0.75 ... 2.5 mm ²
Moisture-Proof Enclosure 4 MU IP54, Z-MFG		
Reliable power loss of incorporated devices		17W (e.g. Z-MS-40/3+Z-USA/230)

Connection diagram

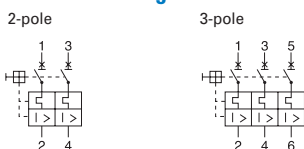

Dimensions (mm)

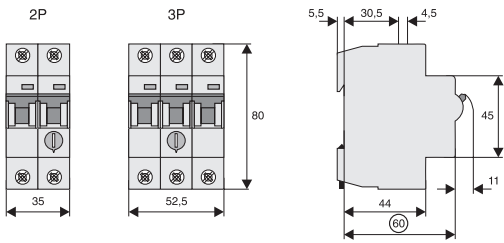

Connection

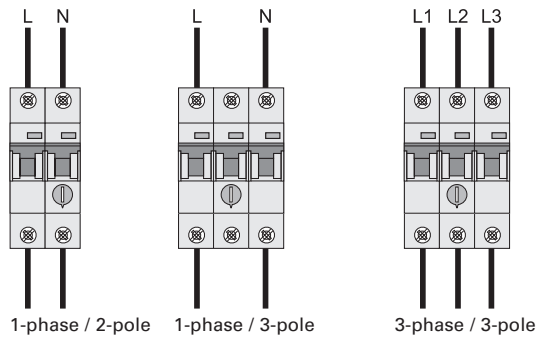

$U_e = 400\text{ V}\sim$
 $I_e = 10 - 16\text{ A}$
 $I_q = 10000\text{ A}$
Z-MS - 25 /3

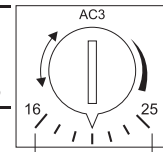

Magnetic release responding current (typ.)
referring to setting range end value ... 16x ... 10x I_e

Selection of Switches for the Protection of Motors

Motor power and current		3-phase		3-phase		Setting ranges of overload release
1-phase 230 - 240 V		230 - 240 V		400 - 415 V		
kW	A	kW	A	kW	A	A
		0.06	0.4	0.06	0.2	0.16 - 0.25
		0.09	0.5	0.09	0.3	0.25 - 0.4
				0.12	0.4	0.4 - 0.63
				0.18	0.6	0.4 - 0.63
0.06	0.7	0.12	0.7	0.25	0.8	0.63 - 1
0.09	0.7					0.63 - 1
0.12	1.3	0.18	1.0	0.37	1.1	1 - 1.6
		0.25	1.4	0.55	1.5	1 - 1.6
0.18	1.9	0.37	2.0	0.75	1.9	1.6 - 2.5
0.25	2.4					1.6 - 2.5
0.37	2.9	0.55	2.7	1.1	2.6	2.5 - 4
		0.8	3.2	1.5	3.6	2.5 - 4
0.55	4.2	1.1	4.6	2.2	5.0	4 - 6.3
0.75	5.6					4 - 6.3
1.1	7.4	1.5	6.3	2.5-3.0	6.6	6.3 - 10
1.5	8.9	2.5	8.7			6.3 - 10
				4.0	8.5	6.3 - 10
2.2	14.5	3.0	11.5	5.5	11.3	10 - 16
				7.5	13.2	10 - 16
3	17.8	4.0	14.8			16 - 20
		5.5	19.6	11.0	21.7	16 - 20
		7.5	26.4	15.0	29.3	25 - 40
		11.0	38.0	18.5	36.0	25 - 40

Overview of Types, Maximum Back-up Fuse and Short-circuit Behaviour

Type	Setting Range (A)	max. Back-up Fuse gL, gG ¹⁾		Typical responding currents of short-circuit releases (A)
		(A) 3 x 230 V	(A) 3 x 400 V	
Z-MS-0.16	0.10 - 0.16			1.3 - 1.7
Z-MS-0.25	0.16 - 0.25			2.0 - 2.6
Z-MS-0.40	0.25 - 0.40			3.1 - 4.8
Z-MS-0.63	0.40 - 0.63			4.9 - 6.6
Z-MS-1.00	0.63 - 1.00			10 - 13
Z-MS-1.60	1.0 - 1.6			16 - 21
Z-MS-2.50	1.6 - 2.5			25 - 33
Z-MS-4.00	2.5 - 4.0			40 - 52
Z-MS-6.30	4.0 - 6.3	100	100	63 - 82
Z-MS-10.0	6.3 - 10.0	100	100	78 - 105
Z-MS-16.0	10.0 - 16.0	100	100	160 - 208
Z-MS-25.0	16.0 - 25.0	100	100	250 - 325
Z-MS-40.0	25.0 - 40.0	100	100	400 - 520

¹⁾ In case of short-circuit currents up to the rated breaking capacity, no back-up fuse is required (inherent current withstand capability)

Connection of Shunt Trip Release

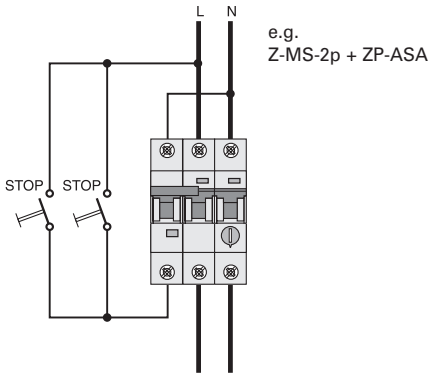

Connection of Undervoltage Release

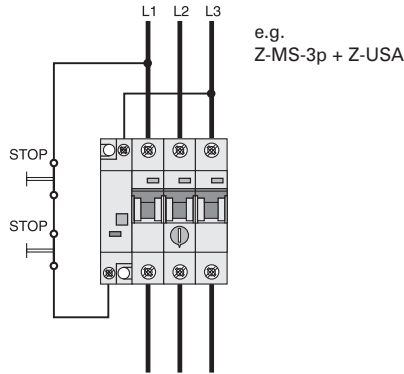

Block Diagram with Remote Switching Device

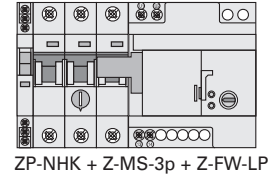

Load Capacity in Case of Block Installation

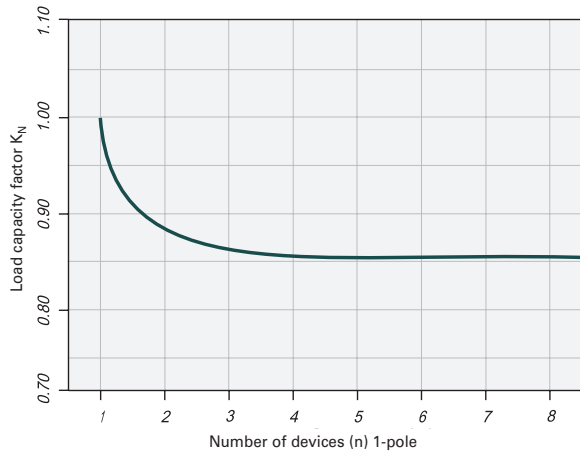

Permitted permanent load at ambient temperature T [°C] with n devices:
 $I_{DL}(T, n) = I_n K_T(T) K_n(n)$

Effect of the Ambient Temperature to the Load Capacity

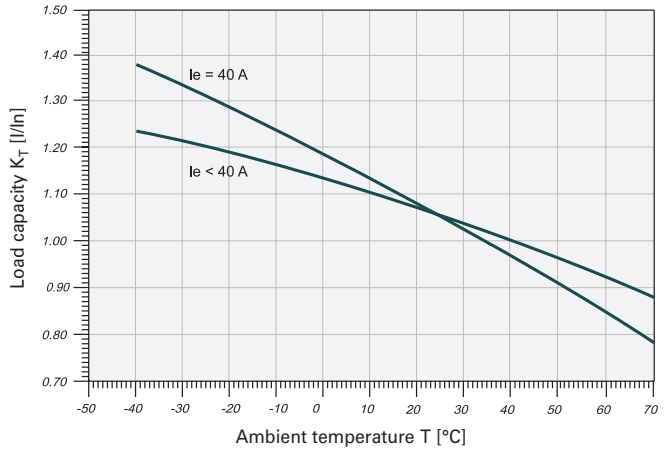

Valid for Z-MS devices, 3-pole, reference ambient temperature 20°C,
 permitted permanent load at ambient temperature T [°C] with n devices:
 $I_L(T) = I_n K_T(T)$

Typical Tripping Characteristic MS 0.16/0,25/0,4/0,63/10A

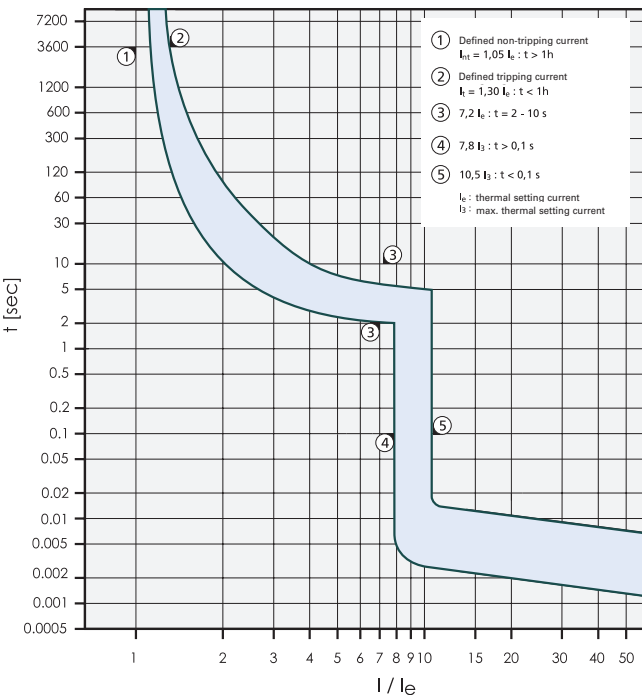

Tripping current as a multiple of the maximum setting current, at an ambient temperature of 20 °C, from cold state

Typical Tripping Characteristic MS 1/1,6/2,5/4/6,3/16/25/40A

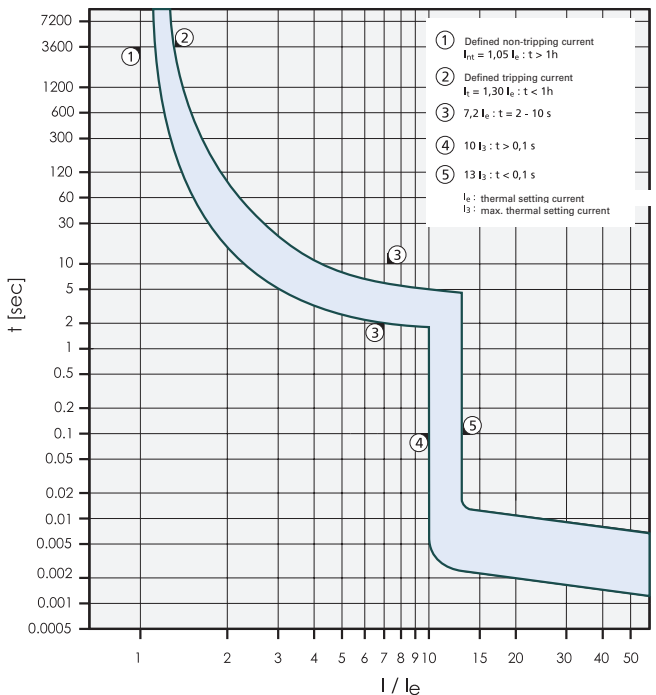

Tripping current as a multiple of the maximum setting current, at an ambient temperature of 20 °C, from cold state

Adjustable MCB Accessory

- Accessories for Adjustable MCB are the same as for PFIM, etc. (releases, auxiliary switches, and busbars)
- Shunt trip release ZP-ASA
- Undervoltage releases
Z-USA: instantaneous
Z-USD: delayed
- Auxiliary switch ZP-IHK: 1 NO + 1 NC
- Tripping signal switch ZP-NHK: 1 CO + 1 CO
- Remote control and automatic switching device Z-FW
- Moisture-proof enclosure IP54
Z-MFG
Z-MFG/NL: with N-led through (solid neutral)
Z-MFG/NOT: with N-led through (solid neutral) and EMERGENCY OFF key

Dimensions (mm)

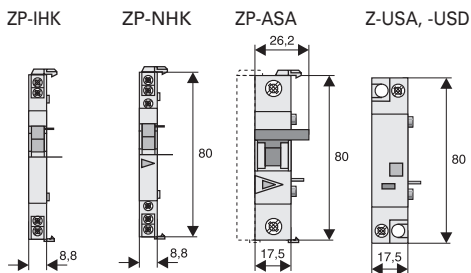

Installation Example

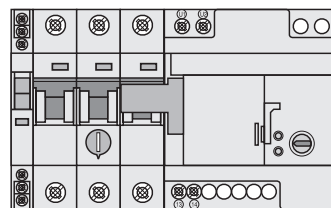

ZP-NHK + Z-MS-2p + Z-FW-LP

Moisture-proof enclosure Z-MFG

- According to EN 50298
- Suitable for manual motor starters Z-MS, e.g. 3p (+ Z-USA); circuit breakers Z-A40
- Earth conductor connection integrated in all types
- Entries for 4 x PG16 cable glands prepared
- Operation: Turning handle, can be locked in the OFF-position by means of 3 padlocks, max. Ø 6 mm
- Enclosure cover can be sealed with leads in 2 locations
- Scope of delivery: 4 entry bushes, 1 mushroom-shaped pushbutton (red) + 1 contact (NC) in Z-MFG/NOT

Technical Data

	Z-MFG	Z-MFG/NL	Z-MFG/NOT
Electrical			
Power Loss of installed devices	max. 17 W	max. 17 W	max. 17 W
Mechanical			
Degree of protection	IP54	IP54	IP54
Protection class	II	II	II
Neutral connection	-	integrated	integrated
Max. Device width	4 MU	4 MU	4 MU
Terminal capacity N/PE	max. 16 mm ²	max. 16 mm ²	max. 16 mm ²
Tightening torque			
N/PE terminals	max. 2 Nm	max. 2 Nm	max. 2 Nm
Cover screws	max. 2 Nm	max. 2 Nm	max. 2 Nm

Dimensions (mm)

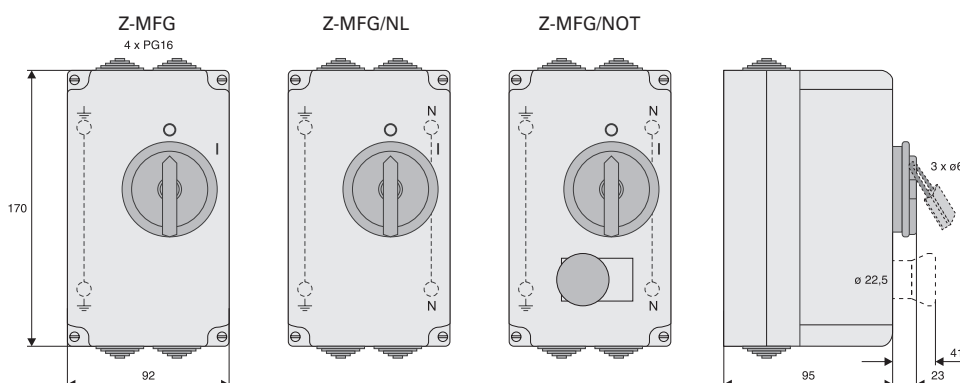

Power Limiter Z-TS

- Type in accordance with EN/IEC 60898-1, EN/IEC 60947
- Shape compatible with and suitable for standard busbar connection to e.g. PLSM, Z-A40, Z-MS, PFIM
- Switching device for voluntary or power-authority limitation of power consumption of user systems and equipment
- Approved by the Austrian regional power supply companies, easy to re-set by the customer
- 1- and 3-pole design
- Adjustment screw for setting range under sealable cover cap

Technical Data

		Z-TS20/.	Z-TS25/.	Z-TS32/.	Z-TS40/.	Z-TS50/.	Z-TS63/.
Electrical							
Rated operating voltage	U_e	230/400 V AC	230/400 V AC	230/400 V AC	230/400 V AC	230/400 V AC	230/400 V AC
Rated frequency		50/60 Hz	50/60 Hz	50/60 Hz	50/60 Hz	50/60 Hz	50/60 Hz
Rated current (Current setpoint values)	I_e	13-16-20 A	16-20-25 A	20-25-32 A	25-32-40 A	40-50 A	50-63 A
Rated impulse withstand voltage	U_{imp}	4 kV (1.2/50 μ s)	4 kV (1.2/50 μ s)	4 kV (1.2/50 μ s)	4 kV (1.2/50 μ s)	4 kV (1.2/50 μ s)	4 kV (1.2/50 μ s)
Rated insulation voltage	U_i	500 V	500 V	500 V	500 V	500 V	500 V
Reference ambient temperature		30 °C	30 °C	30 °C	30 °C	30 °C	30 °C
Tripping method		Overload release and magnetic fast release					
Conventional non-tripping current	I_{nt}	1.13 I_e (t > 1 h)	1.13 I_e (t > 1 h)	1.13 I_e (t > 1 h)	1.13 I_e (t > 1 h)	1.13 I_e (t > 1 h)	1.13 I_e (t > 1 h)
Conventional tripping current	I_t	1.45 I_e (t < 1 h)	1.45 I_e (t < 1 h)	1.45 I_e (t < 1 h)	1.45 I_e (t < 1 h)	1.45 I_e (t < 1 h)	1.45 I_e (t < 1 h)
Response values for the magnetic fast release	I_{MA}	200-300 A	250-375 A	320-500 A	320-500 A	380-500 A	380-500 A
Utilization category		AC-1 (Conventional operating behavior / switch and breaking capacity according to EN/IEC 60947): $I = I_e, U = 1,05 U_e, \cos \varphi = 0.8, 6,000$ operating cycles $I = 1,5 I_e, U = 1,05 U_e, \cos \varphi = 0.8, 50$ operating cycles					
Rated breaking capacity (according to EN/IEC 60868)	I_{cn}	10 kA	10 kA	10 kA	6 kA	6 kA	6 kA
Service short-circuit breaking capacity (acc. to EN/IEC 60868)	I_{cs}	7.5 kA	7.5 kA	7.5 kA	6 kA	6 kA	6 kA
Energy limitation class (according to EN/IEC 60898-1)		3	3	3	3	3	3
Maximum back-up fuse		125 A gL/gG	125 A gL/gG	125 A gL/gG	125 A gL/gG	125 A gL/gG	125 A gL/gG
Mechanical							
Frame size		45 mm	45 mm	45 mm	45 mm	45 mm	45 mm
Device height		80 mm	80 mm	80 mm	80 mm	80 mm	80 mm
Device width		1 MU (1P), 3 MU (3P)	1 MU (1P), 3 MU (3P)	1 MU (1P), 3 MU (3P)	1 MU (1P), 3 MU (3P)	1 MU (1P), 3 MU (3P)	1 MU (1P), 3 MU (3P)
Number of poles		1, 3	1, 3	1, 3	1, 3	1, 3	1, 3
Mounting		quick fastening on DIN rail IEC/EN 60715					
Upper and lower terminals		lift terminals	lift terminals	lift terminals	lift terminals	lift terminals	lift terminals
Terminal capacity single/multi wire		1x(1-25) mm ²	1x(1-25) mm ²	1x(1-25) mm ²	1x(1-25) mm ²	1x(1-25) mm ²	1x(1-25) mm ²
Terminal capacity fine wire with wire end sleeve		1x(0.75-16) mm ²	1x(0.75-16) mm ²	1x(0.75-16) mm ²	1x(0.75-16) mm ²	1x(0.75-16) mm ²	1x(0.75-16) mm ²
Terminal screw		M5, cross recess according to DIN 7962-Z2, Pozidrive					
Terminal torque		max. 2.4 Nm	max. 2.4 Nm	max. 2.4 Nm	max. 2.4 Nm	max. 2.4 Nm	max. 2.4 Nm
Terminal protection		finger and hand touch safe, DGUV VS3, EN 50274					
Resistance to climatic conditions		Damp heat, constant, acc. to IEC 68-2-3 / Damp heat, cyclic, acc. to IEC 68-2-30					

Dimensions (mm)

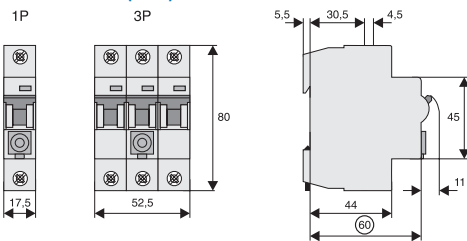

Accessories

- Busbar block ZV
- Auxiliary switch and tripping signal switch Z-AHK, Z-NHK
- Shunt trip release and undervoltage release Z-ASA, Z-USA, Z-USD
- Moisture-proof enclosure Z-MFG

Imprint

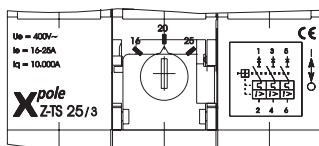

Typical tripping characteristic, e.g. for Z-TS20/3

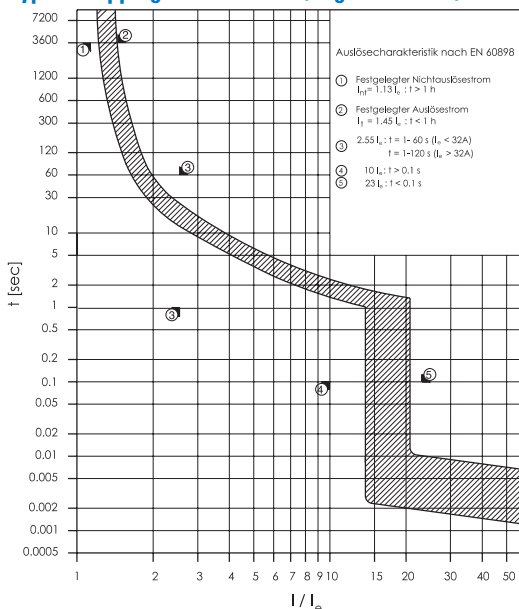

1.6

Adjustable MCB, Power Limiter

xPole

Notes

A large grid area for taking notes, consisting of a 20x30 grid of small squares.



Eaton's electrical business is a global leader with deep regional application expertise in power distribution and circuit protection; power quality, backup power and energy storage; control and automation; life safety and security; structural solutions; and harsh and hazardous environment solutions. Through end-to-end services, channel and an integrated digital platform & insights Eaton is powering what matters across industries and around the world, helping customers solve their most critical electrical power management challenges.

For more information, visit [Eaton.com](https://www.eaton.com).



Eaton Industries (Austria) GmbH
Scheydgasse 42
1210 Vienna
Austria

Eaton
EMEA Headquarters
Route de la Longeraie 7
1110 Morges, Switzerland

© 2022 Eaton
All Rights Reserved
Publication No. CA019014EN
Article number 302574-MK
May 2023

Changes to the products, to the information contained in this document, and to prices are reserved; as are errors and omissions. Only order confirmations and technical documentation by Eaton is binding. Photos and pictures also do not warrant a specific layout or functionality. Their use in whatever form is subject to prior approval by Eaton. The same applies to trademarks (especially Eaton, Moeller, and Cutler-Hammer). The Terms and Conditions of Eaton apply, as referenced on Eaton Internet pages and Eaton order confirmations.

Eaton is a registered trademark.

All other trademarks are property of their respective owners.

Follow us on social media to get the latest product and support information.

