

## Data Sheet | Item Number: 2002-1761

3-conductor carrier terminal block; for DIN-rail 35 x 15 and 35 x 7.5; 2.5 mm<sup>2</sup>; Push-in CAGE CLAMP®; 2,50 mm<sup>2</sup>; gray

<https://www.wago.com/2002-1761>

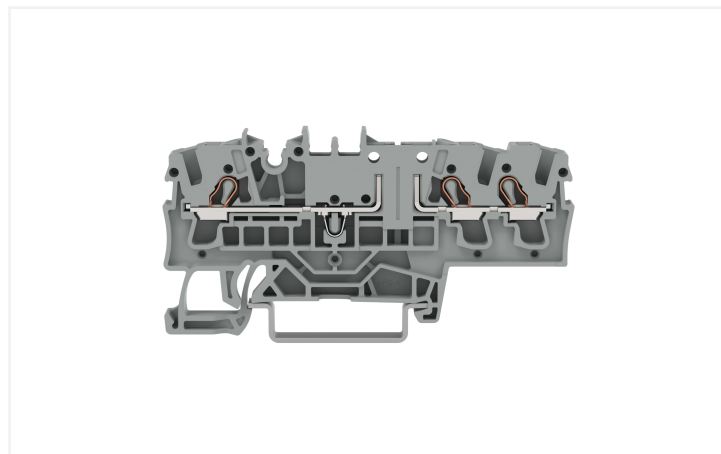
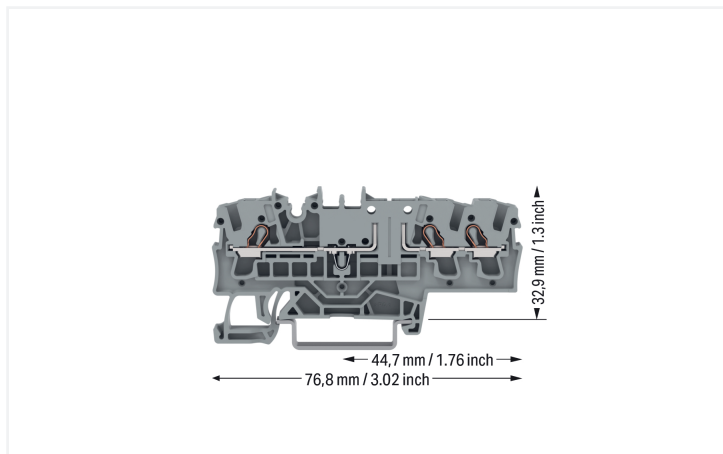

Color: ■ gray

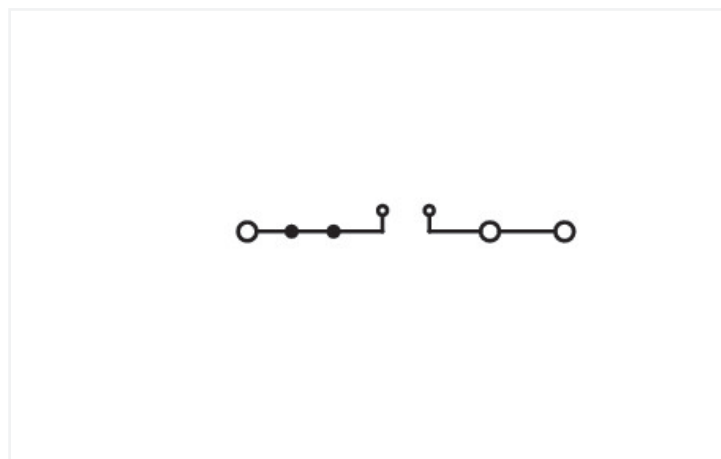
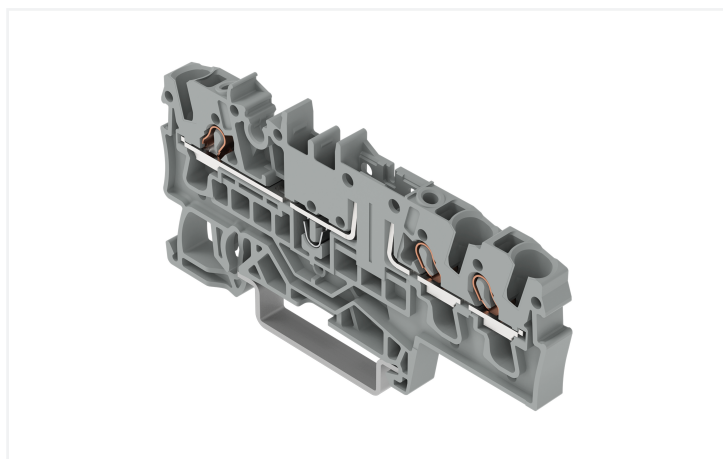

Similar to illustration

Carrier terminal block for modules and plugs, 2002 Series, Push-in CAGE CLAMP®

This carrier terminal block for modules and plugs (item number 2002-1761) is designed to connect electrical conductors quickly and easily. Strip lengths must be between 10 and 12 mm when connecting conductors to this carrier terminal block for modules and plugs. This product features conductor terminals and utilizes Push-in CAGE CLAMP®. Push-in CAGE CLAMP® connection technology is ideal for connecting all conductor types. Both solid and fine-stranded conductors with ferrules can be pushed in without the need for tools—all thanks to its pluggable design. This carrier terminal block for modules and plugs is suitable for conductor cross sections ranging from 0.25 mm<sup>2</sup> to 4 mm<sup>2</sup>.

This product is designed for specific Ex applications (please refer to the product datasheet).

## Notes

## Safety Information

The 2 mm test slot is only approved for high impedance measurement up to max. 100 mA.

## Electrical data

Ratings per	IEC/EN 60947-7-1		
Overvoltage category	III	III	II
Pollution degree	3	2	2
Nominal voltage	400 V	-	-
Rated impulse withstand voltage	6 kV	-	-
Rated current	16 A	-	-

Approvals per	CSA 22.2 No 158		
Use group	B	C	D
Rated voltage	300 V	300 V	-
Rated current	15 A	15 A	-

## Power Loss

Power loss, per pole (potential)	0.3405 W
Rated current $I_N$ for power loss specification	16 A
Resistance value for specified, current-dependent power loss	0.00133 $\Omega$

Approvals per	UL 1059		
Use group	B	C	D
Rated voltage	300 V	300 V	-
Rated current	15 A	15 A	-

## Ex information

Reference to hazardous areas	See "Downloads – Documentation – Additional Information: Technical Section; Technical Explanations"
Ratings per	ATEX: KIWA 17 ATEX 0030 U / IECEx: KIWA 17.0014U (Ex ec IIC Gc)
Rated voltage EN (Ex e II)	440 V
Rated current (Ex e II)	17 A

## General information

Wiring direction	Front-entry wiring
------------------	--------------------

## Connection Data

Clamping units	3
Total number of potentials	2
Number of levels	1
Number of jumper slots	2

## Connection 1

Connection technology	Push-in CAGE CLAMP®
Actuation type	Operating tool
Connectable conductor materials	Copper
Nominal cross-section	2.5 mm <sup>2</sup>
Solid conductor	0.25 ... 4 mm <sup>2</sup> / 22 ... 12 AWG
Solid conductor; push-in termination	0.75 ... 4 mm <sup>2</sup> / 18 ... 12 AWG
Fine-stranded conductor	0.25 ... 4 mm <sup>2</sup> / 22 ... 12 AWG
Fine-stranded conductor; with insulated ferrule	0.25 ... 2.5 mm <sup>2</sup> / 22 ... 14 AWG
Fine-stranded conductor; with ferrule; push-in termination	1 ... 2.5 mm <sup>2</sup> / 18 ... 14 AWG
Note (conductor cross-section)	Depending on the conductor characteristic, a conductor with a smaller cross-section can also be inserted via push-in termination.
Strip length	10 ... 12 mm / 0.39 ... 0.47 inches
Wiring direction	Front-entry wiring

### Physical data

Width	5.2 mm / 0.205 inches
Height	76.8 mm / 3.024 inches
Depth from upper-edge of DIN-rail	32.9 mm / 1.295 inches

### Mechanical data

Mounting type	DIN-35 rail
Marking level	Center/side marking

### Material data

Note (material data)	<a href="#">Information on material specifications can be found here</a>
Color	gray
Material group	I
Insulation material (main housing)	Polyamide (PA66)
Flammability class per UL94	V0
Fire load	0.174 MJ
Weight	8.2 g

### Environmental requirements

Processing temperature	-35 ... +85 °C
Continuous operating temperature	-60 ... +105 °C

### Environmental Testing

Test specification: Railway applications – Rolling stock – Electronic equipment	DIN EN 50155 (VDE 0115-200):2022-06
Test procedure: Railway applications – Rolling stock equipment – Vibration and shock tests	DIN EN 61373 (VDE 0115-0106):2011-04
Spectrum/Mounting location	Service life test, Category 1, Class A/B
Functional test with noise-like oscillations	Test passed according to Section 8 of the standard
Frequency	$f_1 = 5 \text{ Hz}$ to $f_2 = 150 \text{ Hz}$
Acceleration	0.101g (highest test level used for all axes)
Test duration per axis	10 min.
Test directions	X, Y and Z axes
Monitoring of contact faults and interruptions	Passed
Voltage drop measurement before and after each axis	Passed
Simulated service life test through increased levels of noise-like oscillations	Test passed according to Section 9 of the standard
Frequency	$f_1 = 5 \text{ Hz}$ to $f_2 = 150 \text{ Hz}$
Acceleration	0.572g (highest test level used for all axes)
Test duration per axis	5 h
Test directions	X, Y and Z axes
Extended testing: Monitoring of contact faults and interruptions	Passed
Extended testing: Voltage drop measurement before and after each axis	Passed
Shock test	Test passed according to Section 10 of the standard
Shock pulse form	Half sine
Acceleration	5g (highest test level used for all axes)
Shock duration	30 ms
Number of shocks (per axis)	3 pos. und 3 neg.
Test directions	X, Y and Z axes

**Environmental Testing**

Extended testing: Monitoring of contact faults and interruptions	Passed
Extended testing: Voltage drop measurement before and after each axis	Passed
Vibration and shock stress for rolling stock equipment	Passed

**Commercial data**

Product Group	22 (TOPJOB S)
PU (SPU)	50 pcs
Packaging type	Box
Country of origin	CN
GTIN	4055143873420
Customs tariff number	85369010000

**Product Classification**

UNSPSC	39121410
eCl@ss 10.0	27-14-11-20
eCl@ss 9.0	27-14-11-20
ETIM 9.0	EC000897
ETIM 10.0	EC000897
ECCN	NO US CLASSIFICATION

**Environmental Product Compliance**

RoHS Compliance Status	Compliant, No Exemption
------------------------	-------------------------

**Approvals / Certificates**

**General approvals**



Approval	Standard	Certificate Name
CCA DEKRA Certification B.V.	EN 60947	NTR NL-8054
CSA CSA Group	C22.2 No. 158	154112
DEKRA DEKRA Certification B.V.	EN 60947	71-149763
KEMA/KEUR DEKRA Certification B.V.	EN 60947	71-124163

**Declarations of conformity and manufacturer's declarations**



Approval	Standard	Certificate Name
ATEX-Attestation of Conformity WAGO GmbH & Co. KG	-	-
ATEX-Attestation of Conformity WAGO GmbH & Co. KG	-	-
EU-Declaration of Conformity WAGO GmbH & Co. KG	-	-
Railway WAGO GmbH & Co. KG	-	Railway Ready
UK-Declaration of Conformity WAGO GmbH & Co. KG	-	-

Approvals for marine applications



Approval	Standard	Certificate Name
ABS American Bureau of Shipping	EN 60947	24-0152298-PDA
DNV GL Det Norske Veritas, Germanischer Lloyd	-	TAE00001V2
PRS Polski Rejestr Statków	-	TE/1094/880590/23

Approvals for hazardous areas



Approval	Standard	Certificate Name
AEx Underwriters Laboratories Inc.	UL 60079	E185892 (AEx eb IIC resp. Ex eb IIC)
ATEX KIWA Netherlands B.V.	EN 60079	KIWA 17ATEX0030 U
CCC CNEX	GB/T 3836.3	2020312313000180 (Ex ec IIC Gc)
IECEx KIWA Netherlands B.V.	EN 60079	IECEx KIWA 17.0014U (Ex ec IIC Gc)

Downloads

Environmental Product Compliance

Compliance Search
Environmental Product Compliance 2002-1761 <a href="#">↓</a>

Documentation

Bid Text			
2002-1761	24.04.2019	xml 3.88 KB	<a href="#">↓</a>
2002-1761	23.04.2019	docx 15.52 KB	<a href="#">↓</a>

CAD/CAE-Data

CAD data
2D/3D Models 2002-1761 <a href="#">↓</a>

CAE data
EPLAN Data Portal 2002-1761 <a href="#">↓</a>
WSCAD Universe 2002-1761 <a href="#">↓</a>
ZUKEN Portal 2002-1761 <a href="#">↓</a>

## 1 Compatible Products

### 1.1 Required Accessories

#### 1.1.1 End plate

##### 1.1.1.1 End plate



**Item No.: 2002-1791**

End and intermediate plate; 1 mm thick; gray

**Item No.: 2002-1792**

End and intermediate plate; 1 mm thick; orange

### 1.2 Optional Accessories

#### 1.2.1 DIN-rail

##### 1.2.1.1 Mounting accessories



**Item No.: 210-196**

Aluminum carrier rail; 35 x 8.2 mm; 1.6 mm thick; 2 m long; unslotted; similar to EN 60715; silver-colored



**Item No.: 210-198**

Copper carrier rail; 35 x 15 mm; 2.3 mm thick; 2 m long; unslotted; according to EN 60715; copper-colored



**Item No.: 210-508**

Steel carrier rail; 35 x 15 mm; 1.5 mm thick; 2 m long; slotted; galvanized; similar to EN 60715; silver-colored



**Item No.: 210-197**

Steel carrier rail; 35 x 15 mm; 1.5 mm thick; 2 m long; slotted; similar to EN 60715; silver-colored



**Item No.: 210-506**

Steel carrier rail; 35 x 15 mm; 1.5 mm thick; 2 m long; unslotted; galvanized; similar to EN 60715; silver-colored



**Item No.: 210-114**

Steel carrier rail; 35 x 15 mm; 1.5 mm thick; 2 m long; unslotted; similar to EN 60715; silver-colored



**Item No.: 210-118**

Steel carrier rail; 35 x 15 mm; 2.3 mm thick; 2 m long; unslotted; according to EN 60715; silver-colored



**Item No.: 210-115**

Steel carrier rail; 35 x 7.5 mm; 1 mm thick; 2 m long; slotted; according to EN 60715; "Hole width 18 mm; silver-colored



**Item No.: 210-112**

Steel carrier rail; 35 x 7.5 mm; 1 mm thick; 2 m long; slotted; according to EN 60715; "Hole width 25 mm; silver-colored



**Item No.: 210-504**

Steel carrier rail; 35 x 7.5 mm; 1 mm thick; 2 m long; slotted; galvanized; according to EN 60715; silver-colored



**Item No.: 210-113**

Steel carrier rail; 35 x 7.5 mm; 1 mm thick; 2 m long; unslotted; according to EN 60715; silver-colored



**Item No.: 210-505**

Steel carrier rail; 35 x 7.5 mm; 1 mm thick; 2 m long; unslotted; galvanized; according to EN 60715; silver-colored

### 1.2.2 Ferrule

#### 1.2.2.1 Ferrule



**Item No.: 216-241**

Ferrule; Sleeve for 0.5 mm<sup>2</sup> / 20 AWG; insulated; electro-tin plated; electrolytic copper; gastight crimped; acc. to DIN 46228, Part 4/09.90; white



**Item No.: 216-242**

Ferrule; Sleeve for 0.75 mm<sup>2</sup> / 18 AWG; insulated; electro-tin plated; electrolytic copper; gastight crimped; acc. to DIN 46228, Part 4/09.90; gray



**Item No.: 216-262**

Ferrule; Sleeve for 0.75 mm<sup>2</sup> / 18 AWG; insulated; electro-tin plated; electrolytic copper; gastight crimped; acc. to DIN 46228, Part 4/09.90; gray



**Item No.: 216-243**

Ferrule; Sleeve for 1 mm<sup>2</sup> / AWG 18; insulated; electro-tin plated; electrolytic copper; gastight crimped; acc. to DIN 46228, Part 4/09.90; red



**Item No.: 216-263**

Ferrule; Sleeve for 1 mm<sup>2</sup> / AWG 18; insulated; electro-tin plated; electrolytic copper; gastight crimped; acc. to DIN 46228, Part 4/09.90; red



**Item No.: 216-244**

Ferrule; Sleeve for 1.5 mm<sup>2</sup> / AWG 16; insulated; electro-tin plated; electrolytic copper; gastight crimped; acc. to DIN 46228, Part 4/09.90; black



**Item No.: 216-264**

Ferrule; Sleeve for 1.5 mm<sup>2</sup> / AWG 16; insulated; electro-tin plated; electrolytic copper; gastight crimped; acc. to DIN 46228, Part 4/09.90; black



**Item No.: 216-246**

Ferrule; Sleeve for 2.5 mm<sup>2</sup> / AWG 14; insulated; electro-tin plated; electrolytic copper; gastight crimped; acc. to DIN 46228, Part 4/09.90; blue



**Item No.: 216-266**

Ferrule; Sleeve for 2.5 mm<sup>2</sup> / AWG 14; insulated; electro-tin plated; electrolytic copper; gastight crimped; acc. to DIN 46228, Part 4/09.90; blue

### 1.2.3 Installation

#### 1.2.3.1 Cover



**Item No.: 709-156**

Cover; Type 3; suitable for cover carrier, type 3; 1 m long; transparent

#### 1.2.3.2 Cover carrier



**Item No.: 709-169**

Cover carrier; Type 3; incl. fixing/retaining screws and knurled nut; suitable for 279 to 282 and 880 Series rail-mounted terminal blocks; suitable for 264 Series miniature rail-mounted terminal blocks; suitable for 270 Series sensor and actuator terminal blocks; gray

### 1.2.4 Insulation stop

#### 1.2.4.1 Insulation stop



**Item No.: 2002-171**

Insulation stop; 0.25 - 0.5 mm<sup>2</sup>; 5 pieces/strip; light gray



**Item No.: 2002-172**

Insulation stop; 0.75 - 1 mm<sup>2</sup>; 5 pieces/strip; dark gray

### 1.2.5 Jumper

#### 1.2.5.1 Jumper



**Item No.: 2002-400**

Continuous jumper; 2-way; insulated; light gray



**Item No.: 2002-413**

Continuous jumper; 3-way; insulated; light gray



**Item No.: 2002-415**

Continuous jumper; 5-way; insulated; light gray



**Item No.: 2002-423/000-006**

Continuous jumper; from 1 to 3; insulated; blue



**Item No.: 2002-423**

Continuous jumper; from 1 to 3; insulated; light gray



**Item No.: 2002-423/000-005**

Continuous jumper; from 1 to 3; insulated; red



**Item No.: 2002-424/000-006**

Continuous jumper; from 1 to 4; insulated; blue



**Item No.: 2002-424**

Continuous jumper; from 1 to 4; insulated; light gray



**Item No.: 2002-424/000-005**

Continuous jumper; from 1 to 4; insulated; red



**Item No.: 2002-406/020-000**

Delta jumper; insulated; light gray



**Item No.: 2002-410/000-006**

Jumper; 10-way; insulated; blue



**Item No.: 2002-410**

Jumper; 10-way; insulated; light gray



**Item No.: 2002-410/000-005**

Jumper; 10-way; insulated; red



**Item No.: 2002-402/000-006**

Jumper; 2-way; insulated; blue



**Item No.: 2002-402**

Jumper; 2-way; insulated; light gray



**Item No.: 2002-402/000-005**

Jumper; 2-way; insulated; red



**Item No.: 2002-403/000-006**

Jumper; 3-way; insulated; blue



**Item No.: 2002-403**

Jumper; 3-way; insulated; light gray



**Item No.: 2002-403/000-005**

Jumper; 3-way; insulated; red



**Item No.: 2002-404/000-006**

Jumper; 4-way; insulated; blue



**Item No.: 2002-404**

Jumper; 4-way; insulated; light gray



**Item No.: 2002-404/000-005**

Jumper; 4-way; insulated; red



**Item No.: 2002-405/000-006**

Jumper; 5-way; insulated; blue



**Item No.: 2002-405**









Jumper; 5-way; insulated; light gray

1.2.5.1 Jumper

 <b>Item No.: 2002-405/000-005</b> Jumper; 5-way; insulated; red	 <b>Item No.: 2002-406/000-006</b> Jumper; 6-way; insulated; blue	 <b>Item No.: 2002-406</b> Jumper; 6-way; insulated; light gray	 <b>Item No.: 2002-406/000-005</b> Jumper; 6-way; insulated; red
 <b>Item No.: 2002-407/000-006</b> Jumper; 7-way; insulated; blue	 <b>Item No.: 2002-407</b> Jumper; 7-way; insulated; light gray	 <b>Item No.: 2002-407/000-005</b> Jumper; 7-way; insulated; red	 <b>Item No.: 2002-408/000-006</b> Jumper; 8-way; insulated; blue
 <b>Item No.: 2002-408</b> Jumper; 8-way; insulated; light gray	 <b>Item No.: 2002-408/000-005</b> Jumper; 8-way; insulated; red	 <b>Item No.: 2002-409/000-006</b> Jumper; 9-way; insulated; blue	 <b>Item No.: 2002-409</b> Jumper; 9-way; insulated; light gray
 <b>Item No.: 2002-409/000-005</b> Jumper; 9-way; insulated; red	 <b>Item No.: 2002-440</b> Jumper; from 1 to 10; insulated; light gray	 <b>Item No.: 2002-433</b> Jumper; from 1 to 3; insulated; light gray	 <b>Item No.: 2002-434</b> Jumper; from 1 to 4; insulated; light gray
 <b>Item No.: 2002-435</b> Jumper; from 1 to 5; insulated; light gray	 <b>Item No.: 2002-436</b> Jumper; from 1 to 6; insulated; light gray	 <b>Item No.: 2002-437</b> Jumper; from 1 to 7; insulated; light gray	 <b>Item No.: 2002-438</b> Jumper; from 1 to 8; insulated; light gray
 <b>Item No.: 2002-439</b> Jumper; from 1 to 9; insulated; light gray	 <b>Item No.: 2002-480</b> Staggered jumper; 10-way; insulated; light gray	 <b>Item No.: 2002-481</b> Staggered jumper; 11-way; insulated; light gray	 <b>Item No.: 2002-482</b> Staggered jumper; 12-way; insulated; light gray
 <b>Item No.: 2002-473/011-000</b> Staggered jumper; 2-way; from 1 to 3; insulated; light gray	 <b>Item No.: 2002-472</b> Staggered jumper; 2-way; insulated; light gray	 <b>Item No.: 2002-473</b> Staggered jumper; 3-way; insulated; light gray	 <b>Item No.: 2002-475/011-000</b> Staggered jumper; 3-way; insulated; light gray
 <b>Item No.: 2002-474</b> Staggered jumper; 4-way; insulated; light gray	 <b>Item No.: 2002-475</b> Staggered jumper; 5-way; insulated; light gray	 <b>Item No.: 2002-476</b> Staggered jumper; 6-way; insulated; light gray	 <b>Item No.: 2002-477</b> Staggered jumper; 7-way; insulated; light gray
 <b>Item No.: 2002-478</b> Staggered jumper; 8-way; insulated; light gray	 <b>Item No.: 2002-479</b> Staggered jumper; 9-way; insulated; light gray	 <b>Item No.: 2002-477/011-000</b> Staggered jumper; insulated; light gray	 <b>Item No.: 2002-479/011-000</b> Staggered jumper; insulated; light gray
 <b>Item No.: 2002-481/011-000</b> Staggered jumper; insulated; light gray	 <b>Item No.: 2002-405/011-000</b> Star point jumper; 3-way; insulated; light gray	 <b>Item No.: 210-103</b> Wire commoning chain; insulated; black	 <b>Item No.: 210-123</b> Wire commoning chain; insulated; blue

1.2.6 Marking

1.2.6.1 Marker

 <b>Item No.: 2009-145/000-006</b> Mini-WSB In-line; for Smart Printer; 1700 pieces on roll; stretchable 5 - 5.2 mm; plain; snap-on type; blue	 <b>Item No.: 2009-145/000-007</b> Mini-WSB In-line; for Smart Printer; 1700 pieces on roll; stretchable 5 - 5.2 mm; plain; snap-on type; gray	 <b>Item No.: 2009-145/000-023</b> Mini-WSB In-line; for Smart Printer; 1700 pieces on roll; stretchable 5 - 5.2 mm; plain; snap-on type; green	 <b>Item No.: 2009-145/000-012</b> Mini-WSB In-line; for Smart Printer; 1700 pieces on roll; stretchable 5 - 5.2 mm; plain; snap-on type; orange
 <b>Item No.: 2009-145/000-005</b> Mini-WSB In-line; for Smart Printer; 1700 pieces on roll; stretchable 5 - 5.2 mm; plain; snap-on type; red	 <b>Item No.: 2009-145/000-024</b> Mini-WSB In-line; for Smart Printer; 1700 pieces on roll; stretchable 5 - 5.2 mm; plain; snap-on type; violet	 <b>Item No.: 2009-145</b> Mini-WSB In-line; for Smart Printer; 1700 pieces on roll; stretchable 5 - 5.2 mm; plain; snap-on type; white	 <b>Item No.: 2009-145/000-002</b> Mini-WSB In-line; for Smart Printer; 1700 pieces on roll; stretchable 5 - 5.2 mm; plain; snap-on type; yellow

1.2.6.1 Marker



**Item No.: 248-501/000-006**

Mini-WSB marking card; as card; not stretchable; plain; snap-on type; blue

**Item No.: 248-501/000-007**

Mini-WSB marking card; as card; not stretchable; plain; snap-on type; gray

**Item No.: 248-501/000-023**

Mini-WSB marking card; as card; not stretchable; plain; snap-on type; green

**Item No.: 248-501/000-017**

Mini-WSB marking card; as card; not stretchable; plain; snap-on type; light green



**Item No.: 248-501/000-012**

Mini-WSB marking card; as card; not stretchable; plain; snap-on type; orange

**Item No.: 248-501/000-005**

Mini-WSB marking card; as card; not stretchable; plain; snap-on type; red

**Item No.: 248-501/000-024**

Mini-WSB marking card; as card; not stretchable; plain; snap-on type; violet

**Item No.: 248-501**

Mini-WSB marking card; as card; not stretchable; plain; snap-on type; white



**Item No.: 248-501/000-002**

Mini-WSB marking card; as card; not stretchable; plain; snap-on type; yellow

**Item No.: 793-5501/000-006**

WMB marking card; as card; for terminal block width 5 - 17.5 mm; stretchable 5 - 5.2 mm; plain; snap-on type; blue

**Item No.: 793-5501/000-014**

WMB marking card; as card; for terminal block width 5 - 17.5 mm; stretchable 5 - 5.2 mm; plain; snap-on type; brown

**Item No.: 793-5501/000-007**

WMB marking card; as card; for terminal block width 5 - 17.5 mm; stretchable 5 - 5.2 mm; plain; snap-on type; gray



**Item No.: 793-5501/000-023**

WMB marking card; as card; for terminal block width 5 - 17.5 mm; stretchable 5 - 5.2 mm; plain; snap-on type; green

**Item No.: 793-5501/000-017**

WMB marking card; as card; for terminal block width 5 - 17.5 mm; stretchable 5 - 5.2 mm; plain; snap-on type; light green

**Item No.: 793-5501/000-012**

WMB marking card; as card; for terminal block width 5 - 17.5 mm; stretchable 5 - 5.2 mm; plain; snap-on type; orange

**Item No.: 793-5501/000-005**

WMB marking card; as card; for terminal block width 5 - 17.5 mm; stretchable 5 - 5.2 mm; plain; snap-on type; red



**Item No.: 793-5501/000-024**

WMB marking card; as card; for terminal block width 5 - 17.5 mm; stretchable 5 - 5.2 mm; plain; snap-on type; violet

**Item No.: 793-5501**

WMB marking card; as card; for terminal block width 5 - 17.5 mm; stretchable 5 - 5.2 mm; plain; snap-on type; white

**Item No.: 793-5501/000-002**

WMB marking card; as card; for terminal block width 5 - 17.5 mm; stretchable 5 - 5.2 mm; plain; snap-on type; yellow

**Item No.: 2009-115/000-006**

WMB-Inline; for Smart Printer; 1500 pieces on roll; stretchable 5 - 5.2 mm; plain; snap-on type; blue



**Item No.: 2009-115/000-007**

WMB-Inline; for Smart Printer; 1500 pieces on roll; stretchable 5 - 5.2 mm; plain; snap-on type; gray

**Item No.: 2009-115/000-023**

WMB-Inline; for Smart Printer; 1500 pieces on roll; stretchable 5 - 5.2 mm; plain; snap-on type; green

**Item No.: 2009-115/000-017**

WMB-Inline; for Smart Printer; 1500 pieces on roll; stretchable 5 - 5.2 mm; plain; snap-on type; light green

**Item No.: 2009-115/000-012**

WMB-Inline; for Smart Printer; 1500 pieces on roll; stretchable 5 - 5.2 mm; plain; snap-on type; orange



**Item No.: 2009-115/000-005**

WMB-Inline; for Smart Printer; 1500 pieces on roll; stretchable 5 - 5.2 mm; plain; snap-on type; red

**Item No.: 2009-115/000-024**

WMB-Inline; for Smart Printer; 1500 pieces on roll; stretchable 5 - 5.2 mm; plain; snap-on type; violet

**Item No.: 2009-115**

WMB-Inline; for Smart Printer; 1500 pieces on roll; stretchable 5 - 5.2 mm; plain; snap-on type; white

**Item No.: 2009-115/000-002**

WMB-Inline; for Smart Printer; 1500 pieces on roll; stretchable 5 - 5.2 mm; plain; snap-on type; yellow

1.2.6.2 Marking strip



**Item No.: 2009-110**

Marking strips; for Smart Printer; on reel; not stretchable; plain; snap-on type; white

1.2.7 Plug

1.2.7.1 Component module with diode



**Item No.: 2002-800/1000-411**

Component plug; for carrier terminal blocks; 2-pole; with diode 1N4007; 5.2 mm wide; Operating temperature 85°C max.; gray

**Item No.: 2002-800/1000-410**

Component plug; for carrier terminal blocks; 2-pole; with diode 1N4007; anode, left side; 5.2 mm wide; Operating temperature 85°C max.; gray

1.2.7.2 Component module with LED



**Item No.: 2002-800/1000-541**

Component plug; for carrier terminal blocks; 1-pole; LED (red); 5.2 mm wide; Operating temperature 85°C max.; gray

**Item No.: 2002-800/1000-542**

Component plug; for carrier terminal blocks; 1-pole; LED (red); 5.2 mm wide; Operating temperature 85°C max.; gray

**Item No.: 2002-800/1000-836**

Component plug; for carrier terminal blocks; 1-pole; LED (red); 5.2 mm wide; Operating temperature 85°C max.; gray

1.2.7.3 Disconnect plug



**Item No.: 2002-401**

Disconnect plug for carrier terminal blocks; for using a receptacle terminal block as a disconnect terminal block; orange

1.2.7.4 Empty component plug housing



**Item No.: 2002-810**

Empty component plug housing; 10.4 mm wide; 2-pole; Type 2; gray

**Item No.: 2002-820**

Empty component plug housing; 10.4 mm wide; 4-pole; Type 3; gray

**Item No.: 2002-800**

Empty component plug housing; 5.2 mm wide; 2-pole; Type 1; gray

1.2.7.5 Fuse plug



**Item No.: 2003-911/1000-923**

Double fuse plug; for 5 x 20 mm miniature metric fuse; with indicator lamp; 230 V; 10.4 mm wide; gray

**Item No.: 2003-911**

Double fuse plug; for 5 x 20 mm miniature metric fuse; without blown fuse indication; 10.4 mm wide; gray

**Item No.: 2004-911/1000-541**

Fuse plug; with pull-tab; for 5 x 20 mm miniature metric fuse; with indicator lamp; 12 - 30 V; 6.1 mm wide; gray

**Item No.: 2004-911/1000-867**

Fuse plug; with pull-tab; for 5 x 20 mm miniature metric fuse; with indicator lamp; 120 V; 6.1 mm wide; gray



**Item No.: 2004-911/1000-836**

Fuse plug; with pull-tab; for 5 x 20 mm miniature metric fuse; with indicator lamp; 230 V; 6.1 mm wide; gray

**Item No.: 2004-911/1000-542**

Fuse plug; with pull-tab; for 5 x 20 mm miniature metric fuse; with indicator lamp; 30 - 65 V; 6.1 mm wide; gray

**Item No.: 2004-911**

Fuse plug; with pull-tab; for miniature metric fuses 5 x 20 mm and 5 x 25 mm; without blown fuse indication; 6.1 mm wide; gray

1.2.8 Protective warning marker

1.2.8.1 Cover



**Item No.: 2002-115**

Protective warning marker; for 5 terminal blocks; with high-voltage symbol, black; yellow

## 1.2.9 Push-in type wire jumper

### 1.2.9.1 Jumper



**Item No.: 2009-414**

Push-in type wire jumper; 1.5 mm²; insulated; 110 mm long; black



**Item No.: 2009-414/000-005**

Push-in type wire jumper; 1.5 mm²; insulated; 110 mm long; black



**Item No.: 2009-416**

Push-in type wire jumper; 1.5 mm²; insulated; 250 mm long; black



**Item No.: 2009-414/000-006**

Push-in type wire jumper; insulated; 110 mm long; black



**Item No.: 2009-412**

Push-in type wire jumper; insulated; 60 mm long; black

## 1.2.10 Screwless end stop

### 1.2.10.1 Mounting accessories



**Item No.: 249-117**

Screwless end stop; 10 mm wide; for DIN-rail 35 x 15 and 35 x 7.5; gray



**Item No.: 249-116**

Screwless end stop; 6 mm wide; for DIN-rail 35 x 15 and 35 x 7.5; gray

## 1.2.11 Test and measurement

### 1.2.11.1 Testing accessories



**Item No.: 210-136**

Test plug; 2 mm Ø; with 500 mm cable; red

## 1.2.12 Tool

### 1.2.12.1 Operating tool



**Item No.: 210-658**

Operating tool; Blade: 3.5 x 0.5 mm; with a partially insulated shaft; angled; short; multicoloured



**Item No.: 210-720**

Operating tool; Blade: 3.5 x 0.5 mm; with a partially insulated shaft; multicoloured

## Installation Notes

Conductor termination

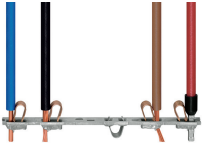

**All conductor types at a glance**

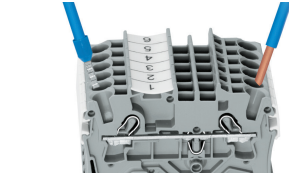

Push-in termination of solid and ferruled conductors

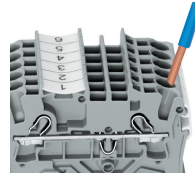

**Inserting a conductor via push-in termination:**  
Solid conductors with cross-sections from either one size above, or up to two sizes below, the rated cross-section can be simply pushed in – no tools needed.

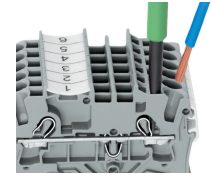

**Inserting a conductor via operating tool:**  
Connecting fine-stranded conductors without ferrules, or small cross-sectional conductors that cannot be pushed in, is performed similarly to the original CAGE CLAMP® – just use an operating tool.  
**Advantage:**  
To open the clamp, the operating tool is inserted vertically. The conductor entry is less than 15 degrees for easier wiring.

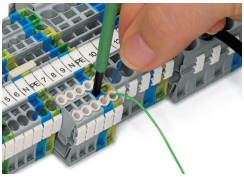

Conductor termination – insulation stop

Commoning

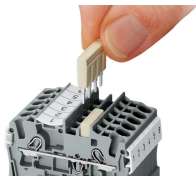

Insert push-in type jumper bar and push down until it hits backstop.

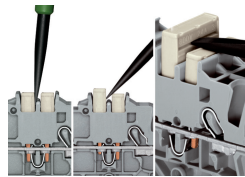

**Removing a push-in type jumper bar:**  
Insert the operating tool between the jumper and partition wall of the dual jumper slots, then lift up the jumper. Place the operating tool in the center of jumpers for up to five contacts (see above), or alternately on both sides for jumpers with more than five contacts.

Commoning

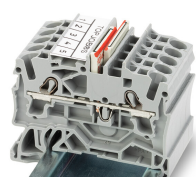

Orient the staggered jumpers' red stripes on the inside. Insert the staggered jumper and push down until it hits the backstop.

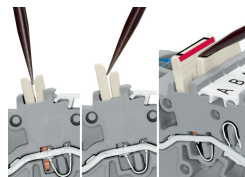

**Removing a staggered jumper:**  
Insert the operating tool between the staggered jumpers, then lift up the jumper.

## Commoning

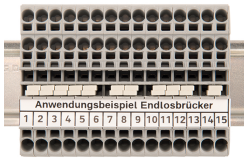

Continuous jumpers (2002 Series) readily connect an endless number of terminal blocks to each other via single jumper slot. Use the second jumper slot for additional commoning or testing.

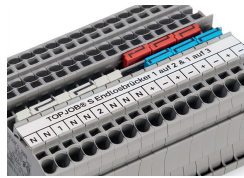

The 1-to-3 adjacent jumper for continuous commoning enables every other terminal block to be commoned. For example, positive and negative potentials can be accommodated alongside each other.

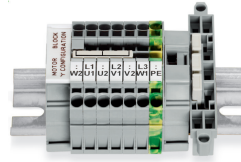

This star point jumper has been specially developed to create a "star point" and is used on motor terminal boards equipped with Rail-Mount Terminal Blocks TOPJOB® S.

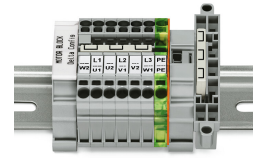

This delta jumper has been specially developed to create a delta configuration and is used on motor terminal boards equipped with rail-mount terminal blocks TOPJOB® S.

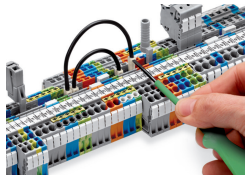

Push down the wire jumper until fully inserted. Lift the jumper with an operating tool for rewiring.

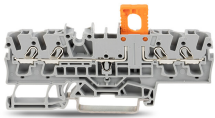

Carrier terminal block (Item No. 2002-1661) with disconnect plug (Item No. 2002-401) in operating position

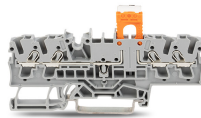

Carrier terminal block (Item No. 2002-1661) with disconnect plug (Item No. 2002-401) in parked position

## Marking

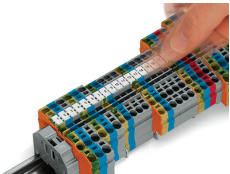

Snapping WMB Inline markers into marker slots.

