

Data Sheet | Item Number: 2002-1702

3-conductor through terminal block; 2.5 mm²; with test option; suitable for Ex e II applications; same profile as 3-conductor disconnect terminal block; side and center marking; for DIN-rail 35 x 15 and 35 x 7.5; Push-in CAGE CLAMP®; 2,50 mm²; orange

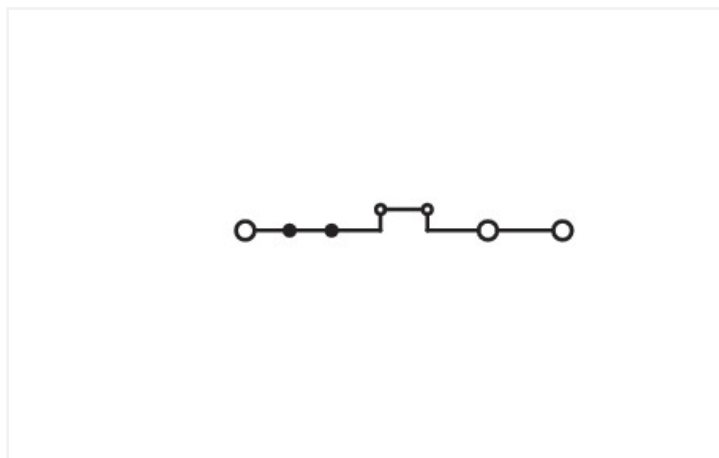

<https://www.wago.com/2002-1702>

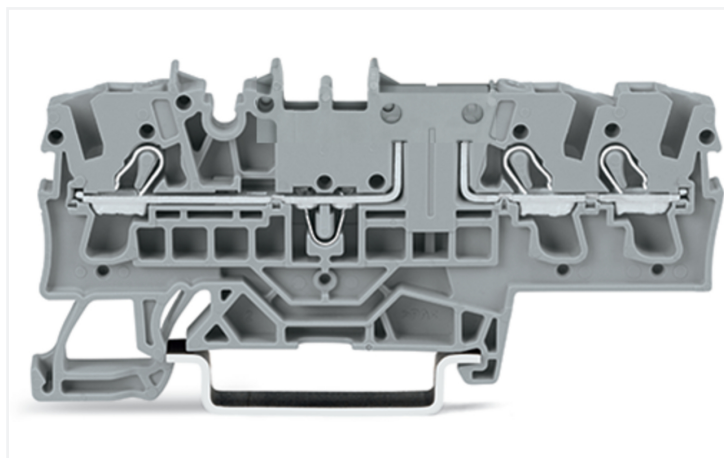

Color: ■ orange

Similar to illustration

Similar to illustration

Through terminal block, 2002 Series, Push-in CAGE CLAMP®

Our through terminal block (item number 2002-1702) makes connections quick and easy. Conductors can only be connected to this through terminal block if their strip length is between 10 and 12 mm. This product incorporates conductor terminals and utilizes Push-in CAGE CLAMP®. Push-in CAGE CLAMP® technology provides a universal connection solution for all conductor types. It allows both solid and fine-stranded conductors with ferrules to be inserted directly into the clamping point without the need for tools. The dimensions are (5.2 x 76.8 x 39.5) mm (width x height x depth). This through terminal block is suitable for conductor cross sections ranging from 0.25 mm² to 4 mm².

This product is designed for specific Ex applications (please refer to the product datasheet).

Notes

Safety Information

The 2 mm test slot is only approved for high impedance measurement up to max. 100 mA.

Electrical data

| Ratings per | IEC/EN 60947-7-1 | | | Approvals per | UL 1059 | | |
|---------------------------------|------------------|-----|----|---------------|-----------|-------|---|
| | III | III | II | | Use group | B | C |
| Overtoltage category | III | III | II | Use group | B | C | D |
| Pollution degree | 3 | 2 | 2 | Rated voltage | 300 V | 300 V | - |
| Nominal voltage | 400 V | - | - | Rated current | 15 A | 15 A | - |
| Rated impulse withstand voltage | 6 kV | - | - | | | | |
| Rated current | 16 A | - | - | | | | |

| Approvals per | CSA 22.2 No 158 | | |
|---------------|-----------------|-------|---|
| Use group | B | C | D |
| Rated voltage | 300 V | 300 V | - |
| Rated current | 15 A | 15 A | - |

| Ex information | |
|------------------------------|---|
| Reference to hazardous areas | See application instructions in section "Knowledge and Downloads – Documentation – Additional Information: Technical Section; Technical Explanations" |
| Ratings per | ATEX: KIWA 17 ATEX 0030 U / IECEx: KIWA 17.0014U (Ex ec IIC Gc) |
| Rated voltage EN (Ex e II) | 440 V |
| Rated current (Ex e II) | 17 A |

| Power Loss | |
|--|------------------|
| Power loss, per pole (potential) | 0.3405 W |
| Rated current I_N for power loss specification | 16 A |
| Resistance value for specified, current-dependent power loss | 0.00133 Ω |

| General information | |
|---------------------|--------------------|
| Wiring direction | Front-entry wiring |

Connection Data

| | |
|----------------------------|---|
| Clamping units | 3 |
| Total number of potentials | 1 |
| Number of levels | 1 |
| Number of jumper slots | 2 |

| Connection 1 | |
|--|---|
| Connection technology | Push-in CAGE CLAMP® |
| Actuation type | Operating tool |
| Connectable conductor materials | Copper |
| Nominal cross-section | 2.5 mm ² |
| Solid conductor | 0.25 ... 4 mm ² / 22 ... 12 AWG |
| Solid conductor; push-in termination | 0.75 ... 4 mm ² / 18 ... 12 AWG |
| Fine-stranded conductor | 0.25 ... 4 mm ² / 22 ... 12 AWG |
| Fine-stranded conductor; with insulated ferrule | 0.25 ... 2.5 mm ² / 22 ... 14 AWG |
| Fine-stranded conductor; with ferrule; push-in termination | 1 ... 2.5 mm ² / 18 ... 14 AWG |
| Note (conductor cross-section) | Depending on the conductor characteristic, a conductor with a smaller cross-section can also be inserted via push-in termination. |
| Strip length | 10 ... 12 mm / 0.39 ... 0.47 inches |
| Wiring direction | Front-entry wiring |

Physical data

| | |
|-----------------------------------|------------------------|
| Width | 5.2 mm / 0.205 inches |
| Height | 76.8 mm / 3.024 inches |
| Depth from upper-edge of DIN-rail | 32.9 mm / 1.295 inches |
| Depth | 39.5 mm / 1.555 inches |

Mechanical data

| | |
|---------------|---------------------|
| Mounting type | DIN-35 rail |
| Marking level | Center/side marking |

Material data

| | |
|------------------------------------|--|
| Note (material data) | Information on material specifications can be found here |
| Color | orange |
| Material group | I |
| Insulation material (main housing) | Polyamide (PA66) |
| Flammability class per UL94 | V0 |
| Fire load | 0.183 MJ |
| Weight | 8.8 g |

Environmental requirements

| | |
|----------------------------------|-----------------|
| Processing temperature | -35 ... +85 °C |
| Continuous operating temperature | -60 ... +105 °C |

Environmental Testing

| | |
|---|---|
| Test specification: Railway applications – Rolling stock – Electronic equipment | DIN EN 50155 (VDE 0115-200):2022-06 |
| Test procedure: Railway applications – Rolling stock equipment – Vibration and shock tests | DIN EN 61373 (VDE 0115-0106):2011-04 |
| Spectrum/Mounting location | Service life test, Category 1, Class A/B |
| Functional test with noise-like oscillations | Test passed according to Section 8 of the standard |
| Frequency | $f_1 = 5 \text{ Hz}$ to $f_2 = 150 \text{ Hz}$ |
| Acceleration | 0.101g (highest test level used for all axes) |
| Test duration per axis | 10 min. |
| Test directions | X, Y and Z axes |
| Monitoring of contact faults and interruptions | Passed |
| Voltage drop measurement before and after each axis | Passed |
| Simulated service life test through increased levels of noise-like oscillations | Test passed according to Section 9 of the standard |
| Frequency | $f_1 = 5 \text{ Hz}$ to $f_2 = 150 \text{ Hz}$ |
| Acceleration | 0.572g (highest test level used for all axes) |
| Test duration per axis | 5 h |
| Test directions | X, Y and Z axes |
| Extended testing: Monitoring of contact faults and interruptions | Passed |
| Extended testing: Voltage drop measurement before and after each axis | Passed |
| Shock test | Test passed according to Section 10 of the standard |
| Shock pulse form | Half sine |
| Acceleration | 5g (highest test level used for all axes) |
| Shock duration | 30 ms |
| Number of shocks (per axis) | 3 pos. und 3 neg. |
| Test directions | X, Y and Z axes |
| Extended testing: Monitoring of contact faults and interruptions | Passed |
| Extended testing: Voltage drop measurement before and after each axis | Passed |
| Vibration and shock stress for rolling stock equipment | Passed |

Commercial data

| | |
|-----------------------|---------------|
| Product Group | 22 (TOPJOB S) |
| PU (SPU) | 50 pcs |
| Packaging type | Box |
| Country of origin | CN |
| GTIN | 4055143873864 |
| Customs tariff number | 85369010000 |

Product Classification

| | |
|-------------|----------------------|
| UNSPSC | 39121410 |
| eCl@ss 10.0 | 27-14-11-20 |
| eCl@ss 9.0 | 27-14-11-20 |
| ETIM 9.0 | EC000897 |
| ETIM 10.0 | EC000897 |
| ECCN | NO US CLASSIFICATION |

Environmental Product Compliance

| | |
|------------------------|-------------------------|
| RoHS Compliance Status | Compliant, No Exemption |
|------------------------|-------------------------|

Approvals / Certificates

General approvals



| Approval | Standard | Certificate Name |
|---------------------------------------|---------------|------------------|
| CCA DEKRA Certification B.V. | EN 60947 | NTR NL-8054 |
| CSA CSA Group | C22.2 No. 158 | 154112 |
| DEKRA DEKRA Certification B.V. | EN 60947 | 71-149763 |
| KEMA/KEUR DEKRA Certification B.V. | EN 60947 | 71-124163 |
| UL Underwriters Laboratories Inc. | UL 1059 | E45172 |

Declarations of conformity and manufacturer's declarations



| Approval | Standard | Certificate Name |
|--|----------|------------------|
| ATEX-Attestation of Conformity WAGO GmbH & Co. KG | - | - |
| ATEX-Attestation of Conformity WAGO GmbH & Co. KG | - | - |
| EU-Declaration of Conformity WAGO GmbH & Co. KG | - | - |
| Railway WAGO GmbH & Co. KG | - | Railway Ready |
| UK-Declaration of Conformity WAGO GmbH & Co. KG | - | - |

Approvals for marine applications



| Approval | Standard | Certificate Name |
|--|----------|-------------------|
| ABS American Bureau of Shipping | EN 60947 | 24-0152298-PDA |
| DNV GL Det Norske Veritas, Germanischer Lloyd | - | TAE00001V2 |
| PRS Polski Rejestr Statków | - | TE/1094/880590/23 |

Approvals for hazardous areas



| Approval | Standard | Certificate Name |
|---------------------------------------|-------------|--------------------------------------|
| AEx Underwriters Laboratories Inc. | UL 60079 | E185892 (AEx eb IIC resp. Ex eb IIC) |
| ATEX KIWA Netherlands B.V. | EN 60079 | KIWA 17ATEX0030 U |
| CCC CNEX | GB/T 3836.3 | 2020312313000180 (Ex ec IIC Gc) |
| IECEX KIWA Netherlands B.V. | EN 60079 | IECEX KIWA 17.0014U (Ex ec IIC Gc) |

Downloads

Environmental Product Compliance

Compliance Search

Environmental Product Compliance 2002-1702



Documentation

Bid Text

| | | | |
|-----------|------------|------------------|--|
| 2002-1702 | 24.04.2019 | xml 3.99 KB | |
| 2002-1702 | 23.04.2019 | docx 15.54 KB | |

CAD/CAE-Data

CAD data

2D/3D Models
2002-1702



CAE data

EPLAN Data Portal
2002-1702



WSCAD Universe
2002-1702



ZUKEN Portal
2002-1702



1 Compatible Products

1.1 Required Accessories

1.1.1 End plate

1.1.1.1 End plate



[Item No.: 2002-1791](#)

End and intermediate plate; 1 mm thick; gray

[Item No.: 2002-1792](#)

End and intermediate plate; 1 mm thick; orange

1.2 Optional Accessories

1.2.1 DIN-rail

1.2.1.1 Mounting accessories



[Item No.: 210-196](#)

Aluminum carrier rail; 35 x 8.2 mm; 1.6 mm thick; 2 m long; unslotted; similar to EN 60715; silver-colored



[Item No.: 210-198](#)

Copper carrier rail; 35 x 15 mm; 2.3 mm thick; 2 m long; unslotted; according to EN 60715; copper-colored



[Item No.: 210-508](#)

Steel carrier rail; 35 x 15 mm; 1.5 mm thick; 2 m long; slotted; galvanized; similar to EN 60715; silver-colored



[Item No.: 210-197](#)

Steel carrier rail; 35 x 15 mm; 1.5 mm thick; 2 m long; slotted; similar to EN 60715; silver-colored



[Item No.: 210-506](#)

Steel carrier rail; 35 x 15 mm; 1.5 mm thick; 2 m long; unslotted; galvanized; similar to EN 60715; silver-colored



[Item No.: 210-114](#)

Steel carrier rail; 35 x 15 mm; 1.5 mm thick; 2 m long; unslotted; similar to EN 60715; silver-colored



[Item No.: 210-118](#)

Steel carrier rail; 35 x 15 mm; 2.3 mm thick; 2 m long; unslotted; according to EN 60715; silver-colored



[Item No.: 210-115](#)

Steel carrier rail; 35 x 7.5 mm; 1 mm thick; 2 m long; slotted; according to EN 60715; "Hole width 18 mm; silver-colored

1.2.1.1 Mounting accessories



Item No.: 210-112

Steel carrier rail; 35 x 7.5 mm; 1 mm thick; 2 m long; slotted; according to EN 60715; "Hole width 25 mm; silver-colored



Item No.: 210-504

Steel carrier rail; 35 x 7.5 mm; 1 mm thick; 2 m long; slotted; galvanized; according to EN 60715; silver-colored



Item No.: 210-113

Steel carrier rail; 35 x 7.5 mm; 1 mm thick; 2 m long; unslotted; according to EN 60715; silver-colored



Item No.: 210-505

Steel carrier rail; 35 x 7.5 mm; 1 mm thick; 2 m long; unslotted; galvanized; according to EN 60715; silver-colored

1.2.2 Ferrule

1.2.2.1 Ferrule



Item No.: 216-241

Ferrule; Sleeve for 0.5 mm² / 20 AWG; insulated; electro-tin plated; electrolytic copper; gastight crimped; acc. to DIN 46228, Part 4/09.90; white



Item No.: 216-242

Ferrule; Sleeve for 0.75 mm² / 18 AWG; insulated; electro-tin plated; electrolytic copper; gastight crimped; acc. to DIN 46228, Part 4/09.90; gray



Item No.: 216-262

Ferrule; Sleeve for 0.75 mm² / 18 AWG; insulated; electro-tin plated; electrolytic copper; gastight crimped; acc. to DIN 46228, Part 4/09.90; gray



Item No.: 216-243

Ferrule; Sleeve for 1 mm² / AWG 18; insulated; electro-tin plated; electrolytic copper; gastight crimped; acc. to DIN 46228, Part 4/09.90; red



Item No.: 216-263

Ferrule; Sleeve for 1 mm² / AWG 18; insulated; electro-tin plated; electrolytic copper; gastight crimped; acc. to DIN 46228, Part 4/09.90; red



Item No.: 216-244

Ferrule; Sleeve for 1.5 mm² / AWG 16; insulated; electro-tin plated; electrolytic copper; gastight crimped; acc. to DIN 46228, Part 4/09.90; black



Item No.: 216-264

Ferrule; Sleeve for 1.5 mm² / AWG 16; insulated; electro-tin plated; electrolytic copper; gastight crimped; acc. to DIN 46228, Part 4/09.90; black



Item No.: 216-246

Ferrule; Sleeve for 2.5 mm² / AWG 14; insulated; electro-tin plated; electrolytic copper; gastight crimped; acc. to DIN 46228, Part 4/09.90; blue



Item No.: 216-266

Ferrule; Sleeve for 2.5 mm² / AWG 14; insulated; electro-tin plated; electrolytic copper; gastight crimped; acc. to DIN 46228, Part 4/09.90; blue

1.2.3 Installation

1.2.3.1 Cover



Item No.: 709-156

Cover; Type 3; suitable for cover carrier, type 3; 1 m long; transparent

1.2.3.2 Cover carrier



Item No.: 709-169

Cover carrier; Type 3; incl. fixing/retaining screws and knurled nut; suitable for 279 to 282 and 880 Series rail-mounted terminal blocks; suitable for 264 Series miniature rail-mounted terminal blocks; suitable for 270 Series sensor and actuator terminal blocks; gray

1.2.4 Insulation stop

1.2.4.1 Insulation stop



Item No.: [2002-171](#)

Insulation stop; 0.25 - 0.5 mm²; 5 pieces/strip; light gray



Item No.: [2002-172](#)

Insulation stop; 0.75 - 1 mm²; 5 pieces/strip; dark gray

1.2.5 Jumper

1.2.5.1 Jumper



Item No.: [2002-400](#)

Continuous jumper; 2-way; insulated; light gray



Item No.: [2002-413](#)

Continuous jumper; 3-way; insulated; light gray



Item No.: [2002-415](#)

Continuous jumper; 5-way; insulated; light gray



Item No.: [2002-423/000-006](#)

Continuous jumper; from 1 to 3; insulated; blue



Item No.: [2002-423](#)

Continuous jumper; from 1 to 3; insulated; light gray



Item No.: [2002-423/000-005](#)

Continuous jumper; from 1 to 3; insulated; red



Item No.: [2002-424/000-006](#)

Continuous jumper; from 1 to 4; insulated; blue



Item No.: [2002-424](#)

Continuous jumper; from 1 to 4; insulated; light gray



Item No.: [2002-424/000-005](#)

Continuous jumper; from 1 to 4; insulated; red



Item No.: [2002-406/020-000](#)

Delta jumper; insulated; light gray



Item No.: [2002-410/000-006](#)

Jumper; 10-way; insulated; blue



Item No.: [2002-410](#)

Jumper; 10-way; insulated; light gray



Item No.: [2002-410/000-005](#)

Jumper; 10-way; insulated; red



Item No.: [2002-402/000-006](#)

Jumper; 2-way; insulated; blue



Item No.: [2002-402](#)

Jumper; 2-way; insulated; light gray



Item No.: [2002-402/000-005](#)

Jumper; 2-way; insulated; red



Item No.: [2002-403/000-006](#)

Jumper; 3-way; insulated; blue



Item No.: [2002-403](#)

Jumper; 3-way; insulated; light gray



Item No.: [2002-403/000-005](#)

Jumper; 3-way; insulated; red



Item No.: [2002-404/000-006](#)

Jumper; 4-way; insulated; blue



Item No.: [2002-404](#)

Jumper; 4-way; insulated; light gray



Item No.: [2002-404/000-005](#)

Jumper; 4-way; insulated; red



Item No.: [2002-405/000-006](#)

Jumper; 5-way; insulated; blue



Item No.: [2002-405](#)

Jumper; 5-way; insulated; light gray



Item No.: [2002-405/000-005](#)

Jumper; 5-way; insulated; red



Item No.: [2002-406/000-006](#)

Jumper; 6-way; insulated; blue



Item No.: [2002-406](#)

Jumper; 6-way; insulated; light gray



Item No.: [2002-406/000-005](#)

Jumper; 6-way; insulated; red



Item No.: [2002-407/000-006](#)

Jumper; 7-way; insulated; blue



Item No.: [2002-407](#)

Jumper; 7-way; insulated; light gray



Item No.: [2002-407/000-005](#)

Jumper; 7-way; insulated; red



Item No.: [2002-408/000-006](#)

Jumper; 8-way; insulated; blue



Item No.: [2002-408](#)

Jumper; 8-way; insulated; light gray



Item No.: [2002-408/000-005](#)

Jumper; 8-way; insulated; red



Item No.: [2002-409/000-006](#)

Jumper; 9-way; insulated; blue



Item No.: [2002-409](#)

Jumper; 9-way; insulated; light gray



Item No.: [2002-409/000-005](#)

Jumper; 9-way; insulated; red



Item No.: [2002-440](#)

Jumper; from 1 to 10; insulated; light gray



Item No.: [2002-433](#)

Jumper; from 1 to 3; insulated; light gray



Item No.: [2002-434](#)

Jumper; from 1 to 4; insulated; light gray



Item No.: [2002-435](#)

Jumper; from 1 to 5; insulated; light gray



Item No.: [2002-436](#)

Jumper; from 1 to 6; insulated; light gray



Item No.: [2002-437](#)

Jumper; from 1 to 7; insulated; light gray



Item No.: [2002-438](#)



Jumper; from 1 to 8; insulated; light gray

1.2.5.1 Jumper





















| | | | |
|---|---|--|--|
|  Item No.: 2002-439 Jumper; from 1 to 9; insulated; light gray |  Item No.: 2002-480 Staggered jumper; 10-way; insulated; light gray |  Item No.: 2002-481 Staggered jumper; 11-way; insulated; light gray |  Item No.: 2002-482 Staggered jumper; 12-way; insulated; light gray |
|  Item No.: 2002-473/011-000 Staggered jumper; 2-way; from 1 to 3; insulated; light gray |  Item No.: 2002-472 Staggered jumper; 2-way; insulated; light gray |  Item No.: 2002-473 Staggered jumper; 3-way; insulated; light gray |  Item No.: 2002-475/011-000 Staggered jumper; 3-way; insulated; light gray |
|  Item No.: 2002-474 Staggered jumper; 4-way; insulated; light gray |  Item No.: 2002-475 Staggered jumper; 5-way; insulated; light gray |  Item No.: 2002-476 Staggered jumper; 6-way; insulated; light gray |  Item No.: 2002-477 Staggered jumper; 7-way; insulated; light gray |
|  Item No.: 2002-478 Staggered jumper; 8-way; insulated; light gray |  Item No.: 2002-479 Staggered jumper; 9-way; insulated; light gray |  Item No.: 2002-477/011-000 Staggered jumper; insulated; light gray |  Item No.: 2002-479/011-000 Staggered jumper; insulated; light gray |
|  Item No.: 2002-481/011-000 Staggered jumper; insulated; light gray |  Item No.: 2002-405/011-000 Star point jumper; 3-way; insulated; light gray |  Item No.: 210-103 Wire commoning chain; insulated; black |  Item No.: 210-123 Wire commoning chain; insulated; blue |

1.2.6 Marking

1.2.6.1 Group marker carrier

| | | |
|--|--|--|
|  Item No.: 2009-191 Group marker carrier; gray |  Item No.: 2009-192 Group marker carrier; gray |  Item No.: 2009-193 Group marker carrier; gray |
|--|--|--|

1.2.6.2 Marker

| | | | |
|--|--|---|--|
|  Item No.: 2009-145/000-006 Mini-WSB Inline; for Smart Printer; 1700 pieces on roll; stretchable 5 - 5.2 mm; plain; snap-on type; blue |  Item No.: 2009-145/000-007 Mini-WSB Inline; for Smart Printer; 1700 pieces on roll; stretchable 5 - 5.2 mm; plain; snap-on type; gray |  Item No.: 2009-145/000-023 Mini-WSB Inline; for Smart Printer; 1700 pieces on roll; stretchable 5 - 5.2 mm; plain; snap-on type; green |  Item No.: 2009-145/000-012 Mini-WSB Inline; for Smart Printer; 1700 pieces on roll; stretchable 5 - 5.2 mm; plain; snap-on type; orange |
|  Item No.: 2009-145/000-005 Mini-WSB Inline; for Smart Printer; 1700 pieces on roll; stretchable 5 - 5.2 mm; plain; snap-on type; red |  Item No.: 2009-145/000-024 Mini-WSB Inline; for Smart Printer; 1700 pieces on roll; stretchable 5 - 5.2 mm; plain; snap-on type; violet |  Item No.: 2009-145 Mini-WSB Inline; for Smart Printer; 1700 pieces on roll; stretchable 5 - 5.2 mm; plain; snap-on type; white |  Item No.: 2009-145/000-002 Mini-WSB Inline; for Smart Printer; 1700 pieces on roll; stretchable 5 - 5.2 mm; plain; snap-on type; yellow |
|  Item No.: 248-501/000-006 Mini-WSB marking card; as card; not stretchable; plain; snap-on type; blue |  Item No.: 248-501/000-007 Mini-WSB marking card; as card; not stretchable; plain; snap-on type; gray |  Item No.: 248-501/000-023 Mini-WSB marking card; as card; not stretchable; plain; snap-on type; green |  Item No.: 248-501/000-017 Mini-WSB marking card; as card; not stretchable; plain; snap-on type; light green |
|  Item No.: 248-501/000-012 Mini-WSB marking card; as card; not stretchable; plain; snap-on type; orange |  Item No.: 248-501/000-005 Mini-WSB marking card; as card; not stretchable; plain; snap-on type; red |  Item No.: 248-501/000-024 Mini-WSB marking card; as card; not stretchable; plain; snap-on type; violet |  Item No.: 248-501 Mini-WSB marking card; as card; not stretchable; plain; snap-on type; white |
|  Item No.: 248-501/000-002 Mini-WSB marking card; as card; not stretchable; plain; snap-on type; yellow |  Item No.: 793-5501/000-006 WMB marking card; as card; for terminal block width 5 - 17.5 mm; stretchable 5 - 5.2 mm; plain; snap-on type; blue |  Item No.: 793-5501/000-014 WMB marking card; as card; for terminal block width 5 - 17.5 mm; stretchable 5 - 5.2 mm; plain; snap-on type; brown |  Item No.: 793-5501/000-007 WMB marking card; as card; for terminal block width 5 - 17.5 mm; stretchable 5 - 5.2 mm; plain; snap-on type; gray |

1.2.6.2 Marker



Item No.: 793-5501/000-023
WMB marking card; as card; for terminal block width 5 - 17.5 mm; stretchable 5 - 5.2 mm; plain; snap-on type; green



Item No.: 793-5501/000-017
WMB marking card; as card; for terminal block width 5 - 17.5 mm; stretchable 5 - 5.2 mm; plain; snap-on type; light green



Item No.: 793-5501/000-012
WMB marking card; as card; for terminal block width 5 - 17.5 mm; stretchable 5 - 5.2 mm; plain; snap-on type; orange



Item No.: 793-5501/000-005
WMB marking card; as card; for terminal block width 5 - 17.5 mm; stretchable 5 - 5.2 mm; plain; snap-on type; red



Item No.: 793-5501/000-024
WMB marking card; as card; for terminal block width 5 - 17.5 mm; stretchable 5 - 5.2 mm; plain; snap-on type; violet



Item No.: 793-5501
WMB marking card; as card; for terminal block width 5 - 17.5 mm; stretchable 5 - 5.2 mm; plain; snap-on type; white



Item No.: 793-5501/000-002
WMB marking card; as card; for terminal block width 5 - 17.5 mm; stretchable 5 - 5.2 mm; plain; snap-on type; yellow



Item No.: 2009-115/000-006
WMB-Inline; for Smart Printer; 1500 pieces on roll; stretchable 5 - 5.2 mm; plain; snap-on type; blue



Item No.: 2009-115/000-007
WMB-Inline; for Smart Printer; 1500 pieces on roll; stretchable 5 - 5.2 mm; plain; snap-on type; gray



Item No.: 2009-115/000-023
WMB-Inline; for Smart Printer; 1500 pieces on roll; stretchable 5 - 5.2 mm; plain; snap-on type; green



Item No.: 2009-115/000-017
WMB-Inline; for Smart Printer; 1500 pieces on roll; stretchable 5 - 5.2 mm; plain; snap-on type; light green



Item No.: 2009-115/000-012
WMB-Inline; for Smart Printer; 1500 pieces on roll; stretchable 5 - 5.2 mm; plain; snap-on type; orange



Item No.: 2009-115/000-005
WMB-Inline; for Smart Printer; 1500 pieces on roll; stretchable 5 - 5.2 mm; plain; snap-on type; red



Item No.: 2009-115/000-024
WMB-Inline; for Smart Printer; 1500 pieces on roll; stretchable 5 - 5.2 mm; plain; snap-on type; violet



Item No.: 2009-115
WMB-Inline; for Smart Printer; 1500 pieces on roll; stretchable 5 - 5.2 mm; plain; snap-on type; white



Item No.: 2009-115/000-002
WMB-Inline; for Smart Printer; 1500 pieces on roll; stretchable 5 - 5.2 mm; plain; snap-on type; yellow

1.2.6.3 Marker carrier



Item No.: 2002-121
Adaptor; gray



Item No.: 2002-161
Adaptor; gray



Item No.: 2009-198
Adaptor; gray

1.2.6.4 Marking strip



Item No.: 2009-110
Marking strips; for Smart Printer; on reel; not stretchable; plain; snap-on type; white

1.2.7 Plug

1.2.7.1 Component module with diode



Item No.: 2002-880/1000-411
Component plug; 2-pole; with diode 1N4007; 10.4 mm wide; Operating temperature 85°C max.; gray

1.2.7.2 Component module with LED



Item No.: 2002-880/1000-541
Component plug; 2-pole; LED (red); 10.4 mm wide; Operating temperature 85°C max.; gray



Item No.: 2002-880/1000-836
Component plug; 2-pole; LED (red); 10.4 mm wide; Operating temperature 85°C max.; gray



Item No.: 2002-880/1000-542
Component plug; 2-pole; LED (red); 10.4 mm wide; Operating temperature 85°C max.; multicoloured

1.2.7.3 Empty component plug housing



Item No.: 2002-880

Empty component plug housing; 10.4 mm wide; 2-pole; Type 4; gray

1.2.8 Protective warning marker

1.2.8.1 Cover



Item No.: 2002-115

Protective warning marker; for 5 terminal blocks; with high-voltage symbol, black; yellow

1.2.9 Push-in type wire jumper

1.2.9.1 Jumper



Item No.: 2009-414

Push-in type wire jumper; 1.5 mm²; insulated; 110 mm long; black



Item No.: 2009-414/000-005

Push-in type wire jumper; 1.5 mm²; insulated; 110 mm long; black



Item No.: 2009-416

Push-in type wire jumper; 1.5 mm²; insulated; 250 mm long; black



Item No.: 2009-414/000-006

Push-in type wire jumper; insulated; 110 mm long; black



Item No.: 2009-412

Push-in type wire jumper; insulated; 60 mm long; black

1.2.10 Screwless end stop

1.2.10.1 Mounting accessories



Item No.: 249-117

Screwless end stop; 10 mm wide; for DIN-rail 35 x 15 and 35 x 7.5; gray



Item No.: 249-116

Screwless end stop; 6 mm wide; for DIN-rail 35 x 15 and 35 x 7.5; gray

1.2.11 Test and measurement

1.2.11.1 Testing accessories



Item No.: 2002-560

Modular TOPJOB®S connector; modular; for jumper contact slot; 10-pole; gray



Item No.: 2002-511

Modular TOPJOB®S connector; modular; for jumper contact slot; 1-pole; gray



Item No.: 2002-552

Modular TOPJOB®S connector; modular; for jumper contact slot; 2-pole; gray



Item No.: 2002-553

Modular TOPJOB®S connector; modular; for jumper contact slot; 3-pole; gray



Item No.: 2002-554

Modular TOPJOB®S connector; modular; for jumper contact slot; 4-pole; gray



Item No.: 2002-555

Modular TOPJOB®S connector; modular; for jumper contact slot; 5-pole; gray



Item No.: 2002-556

Modular TOPJOB®S connector; modular; for jumper contact slot; 6-pole; gray



Item No.: 2002-557

Modular TOPJOB®S connector; modular; for jumper contact slot; 7-pole; gray



Item No.: 2002-558

Modular TOPJOB®S connector; modular; for jumper contact slot; 8-pole; gray



Item No.: 2002-559

Modular TOPJOB®S connector; modular; for jumper contact slot; 9-pole; gray



Item No.: 2002-549

Spacer module; modular; e.g., for bridging commoned terminal blocks; gray



Item No.: 2009-174

Test plug adapter; for 4 mm Ø test plugs; for testing TOPJOB®S rail-mounted terminal blocks; gray

1.2.11.1 Testing accessories



Item No.: 210-136

Test plug; 2 mm Ø; with 500 mm cable; red

Item No.: 2009-182

Testing tap; for max. 2.5 mm²; tool-free connection for individual test wires 0.08 - 2.5 mm; gray

Item No.: 2002-649

TOPJOB®S L-type spacer module; modular; e.g., for bridging commoned terminal blocks; gray

Item No.: 2002-611

TOPJOB®S L-type test plug module; modular; 1-pole; gray

1.2.12 Tool

1.2.12.1 Operating tool



Item No.: 210-658

Operating tool; Blade: 3.5 x 0.5 mm; with a partially insulated shaft; angled; short; multicoloured

Item No.: 210-720

Operating tool; Blade: 3.5 x 0.5 mm; with a partially insulated shaft; multicoloured

Installation Notes

Conductor termination

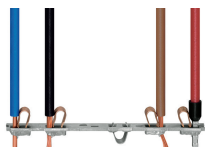

All conductor types at a glance

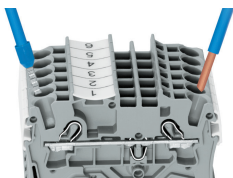

Push-in termination of solid and ferruled conductors

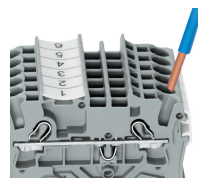

Inserting a conductor via push-in termination:
Solid conductors with cross-sections from either one size above, or up to two sizes below, the rated cross-section can be simply pushed in – no tools needed.

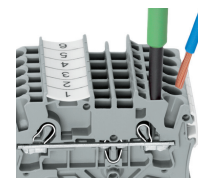

Inserting a conductor via operating tool:
Connecting fine-stranded conductors without ferrules, or small cross-sectional conductors that cannot be pushed in, is performed similarly to the original CAGE CLAMP® – just use an operating tool.
Advantage:
To open the clamp, the operating tool is inserted vertically. The conductor entry is less than 15 degrees for easier wiring.

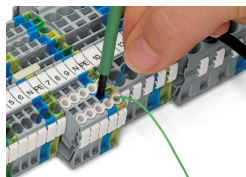

Conductor termination – insulation stop

Commoning

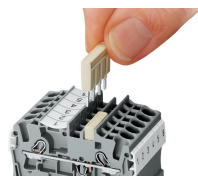

Insert push-in type jumper bar and push down until it hits backstop.

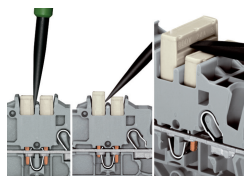

Removing a push-in type jumper bar:
Insert the operating tool between the jumper and partition wall of the dual jumper slots, then lift up the jumper.
Place the operating tool in the center of jumpers for up to five contacts (see above), or alternately on both sides for jumpers with more than five contacts.

Commoning

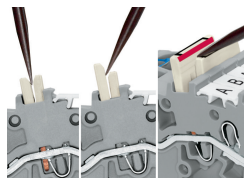

Orient the staggered jumpers' red stripes on the inside. Insert the staggered jumper and push down until it hits the backstop.

Removing a staggered jumper: Insert the operating tool between the staggered jumpers, then lift up the jumper.

Commoning

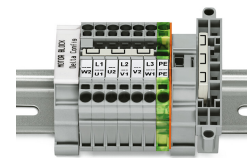
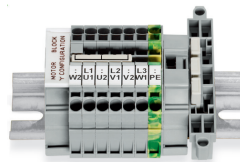
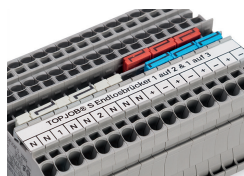

Continuous jumpers (2002 Series) readily connect an endless number of terminal blocks to each other via single jumper slot. Use the second jumper slot for additional commoning or testing.

The 1-to-3 adjacent jumper for continuous commoning enables every other terminal block to be commoned. For example, positive and negative potentials can be accommodated alongside each other.

This star point jumper has been specially developed to create a "star point" and is used on motor terminal boards equipped with Rail-Mount Terminal Blocks TOPJOB® S.

This delta jumper has been specially developed to create a delta configuration and is used on motor terminal boards equipped with rail-mount terminal blocks TOPJOB® S.

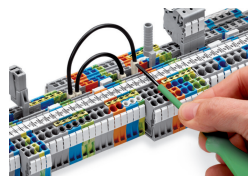

Push down the wire jumper until fully inserted. Lift the jumper with an operating tool for rewiring.

Testing

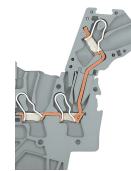
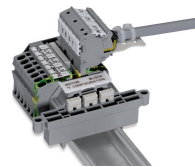
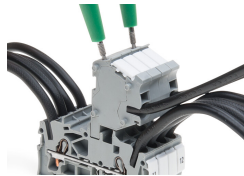
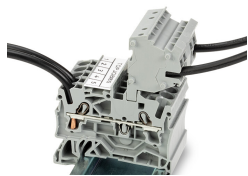

The modular TOPJOB® S connectors also connect conductors of the same size as the terminal blocks being used.

TOPJOB® S Connectors with a 2 mm Ø test socket for testing voltage via 2-pole voltage tester

Rail-mount terminal block assembly for electric motor wiring

L-type test plug module – cross-sectional view of contacts



Test plug adapter (2009-174, CAT I) for 4 mm Ø plugs – compatible with 2000 to 2016 Series

Testing tap (2009-182) for tool-free connection of test cables up to 2.5 mm² (12 AWG) – compatible with 2000 to 2016 Series

Marking

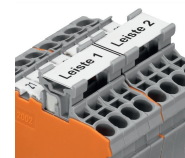
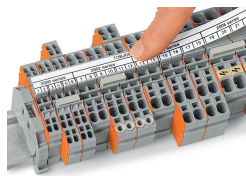
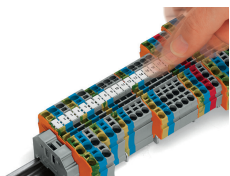

Snapping WMB Inline markers into marker slots.

TOPJOB® S 2009-193 Group Marker Carrier (equipped with a marking strip) for all 2001 to 2016 Series TOPJOB® S Rail-Mount Terminal Blocks
Do not use on an end plate!

Using marker carriers for marking strips (2002-161) in jumper slots.

Ex application

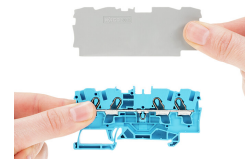
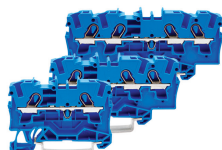
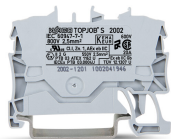

Through terminal blocks with a blue insulated housing are suitable for Ex i applications.

All through and ground conductor terminal blocks are suitable for Ex e II applications.

Separator plate for Ex e/Ex i applications

An end plate must be applied to the terminal block located directly behind an Ex e/Ex i separator plate.

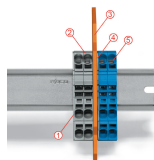

Ex e II/Ex i terminal strip

Note:
The movable feet of terminal blocks and separator plates must face the same direction.

A separator plate is located between the Ex e II and Ex i terminal strip.
End plate
Ex e II terminal blocks
Separator plate for Ex e/Ex i applications
End plate
Ex i terminal blocks
According to EN 50020, a minimum distance of 50 mm must be kept between live parts of Ex e and Ex i circuits. The use of Ex e/Ex i separators is a space-saving solution when Ex e and Ex i terminal blocks are mounted on a common DIN-rail.