

SYLVEO LED 8000LM ROAD ASYMMETRIC 4K DALI 0049141



Features

- Exterior LED floodlight, comes complete with a 1000mm cable and adjustable bracket, aluminium housing, clear glass diffuser, 8542lm, 80W, 106lm/W, 4000K, 2280mA, CRI70, 52°x117° beam angle, DALI dimmable, IP66, IK08, Class I, 50000hrs, (LxWxD) 66x290x333mm

Product Overview

Product name	SYLVEO LED 8000LM ROAD ASYMMETRIC 4K DALI
Technology	LED
Housing	Aluminium
Mount	Wall surface mounted
Fixture rating	Enclosed
E-number FI	4579199
E-number SE	7764819
Fixture luminous flux (lm)	8542
Luminaire efficacy (lm/W)	107
LOR (%)	100
Colour temperature (K)	4000
Light colour	Neutral White
CRI (Ra)	70
Colour Variation Initial (SDCM)	6
Beam Angle (°)	52 x 117
Glare control	< 18
Photobiological Risk Group	RG1
Total power consumption (W)	80
Electrical protection	Class I
Control gear type	Electronic ballast

SYLVEO LED 8000LM ROAD ASYMMETRIC 4K DALI 0049141

LED Flickering Rate	Ultra low (5% or less)
Housing colour	RAL 9006 - Aluminium
IP rating	IP66
IK rating	IK08
Product EAN number	5410288491417
Warranty	5 years

Photometry

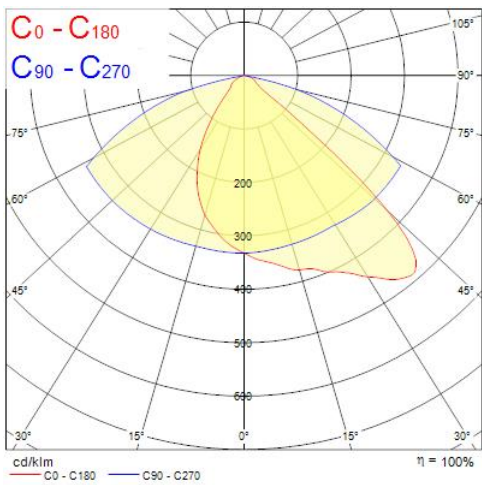

Technical drawings

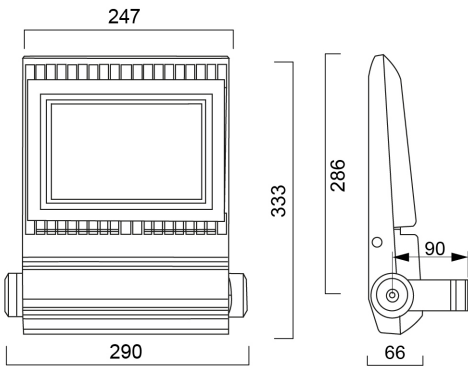

SYLVEO LED 8000LM ROAD ASYMMETRIC 4K DALI 0049141

Data table

GENERAL DATA

Product name	SYLVEO LED 8000LM ROAD ASYMMETRIC 4K DALI
Technology	LED
Housing	Aluminium
Mount	Wall surface mounted
Fixture rating	Enclosed
Operating temperature range (°C)	-40°C...+45°C
Performance ambient temperature Tq (°C)	25
E-number FI	4579199
E-number SE	7764819
Warranty	5 years

OPTICAL DATA

Fixture luminous flux (lm)	8542
Luminaire efficacy (lm/W)	107
LOR (%)	100
Colour temperature (K)	4000
Light colour	Neutral White
CRI (Ra)	70
Colour Variation Initial (SDCM)	6
Beam Angle (°)	52 x 117
Glare control	< 18
Photobiological Risk Group	RG1

ELECTRICAL DATA

Total power consumption (W)	80
Current (A)	0.6
Primary Supply/Product voltage - min (V)	100.0
Lamp power factor	0.95

SYLVEO LED 8000LM ROAD ASYMMETRIC 4K DALI 0049141

Electrical protection	Class I
Control gear required	No
Control gear type	Electronic ballast
Drive current (mA)	2280
Inrush Current (A)	60
Inrush Duration (µs)	850
Glow Wire Test (°C)	650
Nominal Frequency (Hz)	50/60Hz
LED Flickering Rate	Ultra low (5% or less)
Max. products per 10A C Breaker	4
Max. products per 20A B Breaker	4
Mains surge immunity (differential mode -> L-N) (kV)	4
Mains surge immunity (common mode -> L/N - GND) (kV)	6

LIFETIME DATA

Lifespan L70 B50	50000
Lifespan L80 B50	49000

PHYSICAL DATA

Housing colour	RAL 9006 - Aluminium
IP rating	IP66
IK rating	IK08
Diffuser finish	Transparent
Diffuser material	Glass
Nominal Product Length (mm)	290
Nominal Product Width (mm)	66
Weight (kg)	4.541

PACKAGING

Single packaging type	Carton
Product EAN number	5410288491417
Packaging single width (cm)	13.2

SYLVEO LED 8000LM ROAD ASYMMETRIC 4K DALI 0049141

Packaging single depth (cm)	41.75
DUN14 (outer)	15410288491414
Packaging outer length / height (cm)	33.4

SAFETY DATA

Optimal operating condition (°C)	-40-45
Special purpose lamp	No
Dry applications use only	No
Suitable for household illumination	No