

Data Sheet | Item Number: 2002-1811/1000-541

4-conductor fuse terminal block; with pivoting fuse holder; with end plate; for 5 x 20 mm miniature metric fuse; with blown fuse indication by LED; 12 - 30 V; for DIN-rail 35 x 15 and 35 x 7.5; 2.5 mm²; Push-in CAGE CLAMP®; 2,50 mm²; gray

<https://www.wago.com/2002-1811/1000-541>

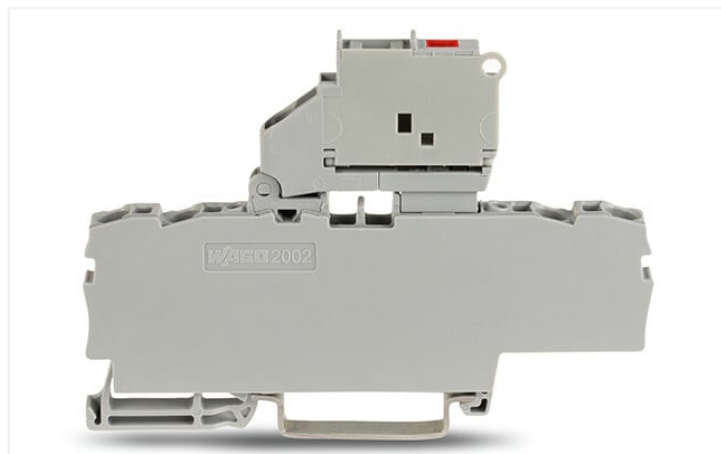
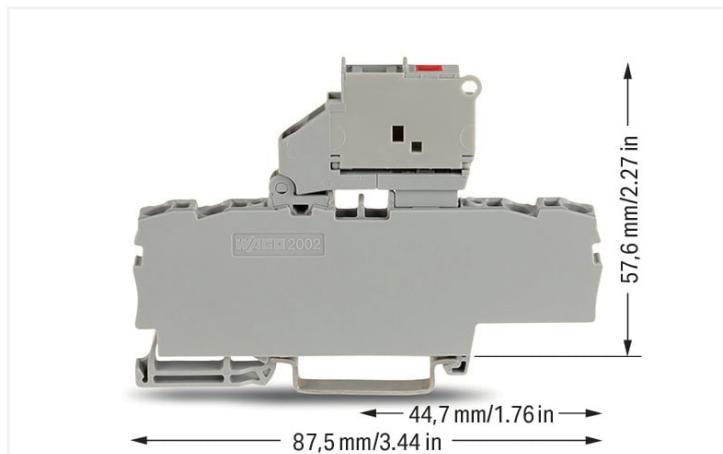

Color: ■ gray

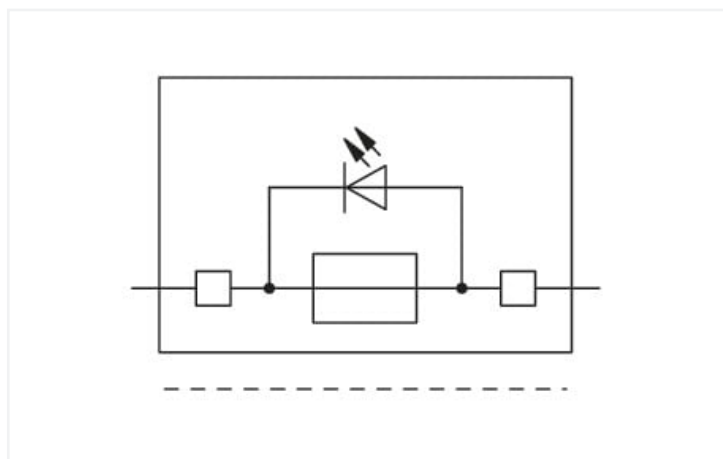

Electrical data

Ratings per	IEC/EN 60947-7-3		
Overvoltage category	III	III	II
Pollution degree	3	2	2
Nominal voltage	250 V	-	-
Rated surge voltage	6 kV	-	-
Rated current	6.3 A	-	-

Approvals per	UL 1059		
Use group	B	C	D
Rated voltage	30 V	30 V	30 V
Rated current	10 A	10 A	10 A

Ratings per	IEC/EN 60947-7-3		
Overvoltage category	III	III	II
Pollution degree	3	2	2
Nominal voltage	30 V	-	-
Rated surge voltage	0.8 kV	-	-
Rated current	-	-	-

Approvals per	CSA 22.2 No 158		
Use group	B	C	D
Rated voltage	250 V	250 V	-
Rated current	6.3 A	6.3 A	-

Ex information

Reference hazardous areas	See "Downloads – Documentation – Additional Information: Technical Section; Technical Explanations"
Ratings per	ATEX: KIWA 17 ATEX 0030 U / IECEx: KIWA 17.0014U (Ex ec IIC Gc)
Rated voltage EN (Ex e II)	24 V
Rated current (Ex e II)	6.3 A

General information

Fuse receptacle	pivoting
Fuse type	Cylindrical fuse; 5 x 20 mm

Connection data

Connection points	4
Total number of potentials	1
Number of levels	1
Number of jumper slots	2

Connection 1

Connection technology	Push-in CAGE CLAMP®
Actuation type	Operating tool
Connectable conductor materials	Copper
Nominal cross-section	2.5 mm ²
Solid conductor	0.25 ... 4 mm ² / 22 ... 12 AWG
Solid conductor; push-in termination	0.75 ... 4 mm ² / 18 ... 12 AWG
Fine-stranded conductor	0.25 ... 4 mm ² / 22 ... 12 AWG
Fine-stranded conductor; with insulated ferrule	0.25 ... 2.5 mm ² / 22 ... 14 AWG
Fine-stranded conductor; with ferrule; push-in termination	1 ... 2.5 mm ² / 18 ... 14 AWG
Note (conductor cross-section)	Depending on the conductor characteristic, a conductor with a smaller cross-section can also be inserted via push-in termination.
Strip length	10 ... 12 mm / 0.39 ... 0.47 inches
Wiring direction	Front-entry wiring

Physical data

Width	6.2 mm / 0.244 inches
Height	87.5 mm / 3.445 inches
Depth from upper-edge of DIN-rail	57.6 mm / 2.268 inches

Mechanical data

Mounting type	DIN-35 rail
Marking level	Center/side marking

Material data

Note (material data)	Information on material specifications can be found here
Color	gray
Material group	I
Insulation material	Polyamide (PA66)
Flammability class per UL94	V0
Fire load	0.352 MJ
Weight	16.4 g

Environmental requirements

Ambient temperature (operation)	-35 ... +70 °C
Processing temperature	-35 ... +70 °C
Continuous operating temperature	-35 ... +70 °C

Commercial data

Product Group	22 (TOPJOB S)
eCl@ss 10.0	27-14-11-16
eCl@ss 9.0	27-14-11-16
ETIM 8.0	EC000899
ETIM 7.0	EC000899
PU (SPU)	50 pcs
Packaging type	Box
Country of origin	CN
GTIN	4066966335811
Customs tariff number	85369095000

Environmental Product Compliance

CAS-No.	7439-92-1 7440-43-9
REACH Candidate List Substance	Cadmium Lead
RoHS Compliance Status	Compliant,With Exemption
RoHS Exemption	7(a) 7(c)-I
SCIP notification number (Austria)	d0b30d52-73d3-4a2a-a411-48f0be3ee0e4
SCIP notification number (Belgium)	813c9825-02f2-4924-a88c-4748fea40a85
SCIP notification number (Bulgaria)	eb314a5a-9b9d-4b08-b7f3-8722968e7b39
SCIP notification number (Czech Republic)	ee713557-b66f-45d8-a6fe-f7980a062275
SCIP notification number (Denmark)	dd7e8b88-3a87-4f7a-85f3-fb69ea3b72c1
SCIP notification number (Finland)	f9d5db8b-1373-4249-bb38-ec2705911021
SCIP notification number (France)	061286d0-e9b9-45fd-b8f4-23830ea0aab9
SCIP notification number (Germany)	ae03cb31-d922-426e-8e39-0d15285820be
SCIP notification number (Hungary)	59bb5d50-aa15-43ae-8743-b030b65e7d57
SCIP notification number (Italy)	00c1a702-920b-40d8-b02a-fb863e652135
SCIP notification number (Netherlands)	ed2a5c75-86f2-4bca-a166-1fdc9fdb74b1
SCIP notification number (Poland)	ecbda195-814e-4317-bdad-d3839b32fa84
SCIP notification number (Romania)	5cba95f8-a425-4c6c-81c2-91cdd82d7ebb
SCIP notification number (Sweden)	b8a321a4-49d6-46ff-a8f3-e9fce4b5d820

Approvals / Certificates

Declarations of conformity and manufacturer's declarations

Approval	Standard	Certificate Name
ATEX-Attestation of Conformity WAGO GmbH & Co. KG	-	-
EU-Declaration of Conformity WAGO GmbH & Co. KG	-	-
UK-Declaration of Conformity WAGO GmbH & Co. KG	-	-

Downloads

Environmental Product Compliance

Compliance Search

Environmental Product Compliance
2002-1811/1000-541



Documentation

Additional Information

Technical Section

pdf
2240.62 KB



Bid Text

2002-1811/1000-541

24.04.2019

xml
4.29 KB



2002-1811/1000-541

23.04.2019

docx
15.67 KB



CAD/CAE-Data

CAD data

2D/3D Models
2002-1811/1000-541



CAE data

EPLAN Data Portal
2002-1811/1000-541



WSCAD Universe
2002-1811/1000-541



ZUKEN Portal
2002-1811/1000-541



1 Compatible Products

1.1 Required Accessories

1.1.1 End plate

1.1.1.1 End plate



Item No.: 209-191

Separator for Ex e/Ex i applications; 3 mm thick; 120 mm wide; orange

1.2 Optional Accessories

1.2.1 DIN-rail

1.2.1.1 Mounting accessories



Item No.: 210-196

Aluminum carrier rail; 35 x 8.2 mm; 1.6 mm thick; 2 m long; unslotted; similar to EN 60715; silver-colored



Item No.: 210-198

Copper carrier rail; 35 x 15 mm; 2.3 mm thick; 2 m long; unslotted; according to EN 60715; copper-colored



Item No.: 210-508

Steel carrier rail; 35 x 15 mm; 1.5 mm thick; 2 m long; slotted; galvanized; similar to EN 60715; silver-colored



Item No.: 210-197

Steel carrier rail; 35 x 15 mm; 1.5 mm thick; 2 m long; slotted; similar to EN 60715; silver-colored

1.2.1.1 Mounting accessories



Item No.: 210-506

Steel carrier rail; 35 x 15 mm; 1.5 mm thick; 2 m long; unslotted; galvanized; similar to EN 60715; silver-colored



Item No.: 210-114

Steel carrier rail; 35 x 15 mm; 1.5 mm thick; 2 m long; unslotted; similar to EN 60715; silver-colored



Item No.: 210-118

Steel carrier rail; 35 x 15 mm; 2.3 mm thick; 2 m long; unslotted; according to EN 60715; silver-colored



Item No.: 210-115

Steel carrier rail; 35 x 7.5 mm; 1 mm thick; 2 m long; slotted; according to EN 60715; "Hole width 18 mm; silver-colored



Item No.: 210-112

Steel carrier rail; 35 x 7.5 mm; 1 mm thick; 2 m long; slotted; according to EN 60715; "Hole width 25 mm; silver-colored



Item No.: 210-504

Steel carrier rail; 35 x 7.5 mm; 1 mm thick; 2 m long; slotted; galvanized; according to EN 60715; silver-colored



Item No.: 210-113

Steel carrier rail; 35 x 7.5 mm; 1 mm thick; 2 m long; unslotted; according to EN 60715; silver-colored



Item No.: 210-505

Steel carrier rail; 35 x 7.5 mm; 1 mm thick; 2 m long; unslotted; galvanized; according to EN 60715; silver-colored

1.2.2 End plate

1.2.2.1 End plate



Item No.: 2002-991

End plate for fuse terminal blocks; 2 mm thick; gray



Item No.: 2002-992

End plate for fuse terminal blocks; 2 mm thick; orange

1.2.3 Ferrule

1.2.3.1 Ferrule



Item No.: 216-241

Ferrule; Sleeve for 0.5 mm² / 20 AWG; insulated; electro-tin plated; electrolytic copper; gastight crimped; acc. to DIN 46228, Part 4/09.90; white



Item No.: 216-242

Ferrule; Sleeve for 0.75 mm² / 18 AWG; insulated; electro-tin plated; electrolytic copper; gastight crimped; acc. to DIN 46228, Part 4/09.90; gray



Item No.: 216-262

Ferrule; Sleeve for 0.75 mm² / 18 AWG; insulated; electro-tin plated; electrolytic copper; gastight crimped; acc. to DIN 46228, Part 4/09.90; gray



Item No.: 216-243

Ferrule; Sleeve for 1 mm² / AWG 18; insulated; electro-tin plated; electrolytic copper; gastight crimped; acc. to DIN 46228, Part 4/09.90; red



Item No.: 216-263

Ferrule; Sleeve for 1 mm² / AWG 18; insulated; electro-tin plated; electrolytic copper; gastight crimped; acc. to DIN 46228, Part 4/09.90; red



Item No.: 216-244

Ferrule; Sleeve for 1.5 mm² / AWG 16; insulated; electro-tin plated; electrolytic copper; gastight crimped; acc. to DIN 46228, Part 4/09.90; black



Item No.: 216-264

Ferrule; Sleeve for 1.5 mm² / AWG 16; insulated; electro-tin plated; electrolytic copper; gastight crimped; acc. to DIN 46228, Part 4/09.90; black



Item No.: 216-246

Ferrule; Sleeve for 2.5 mm² / AWG 14; insulated; electro-tin plated; electrolytic copper; gastight crimped; acc. to DIN 46228, Part 4/09.90; blue



Item No.: 216-266

Ferrule; Sleeve for 2.5 mm² / AWG 14; insulated; electro-tin plated; electrolytic copper; gastight crimped; acc. to DIN 46228, Part 4/09.90; blue

1.2.4 Installation

1.2.4.1 Cover



Item No.: 709-156

Cover; Type 3; suitable for cover carrier, type 3; 1 m long; transparent

1.2.4.2 Cover carrier



Item No.: 709-169

Cover carrier; Type 3; incl. fixing/retaining screws and knurled nut; suitable for 279 to 282 and 880 Series rail-mounted terminal blocks; suitable for 264 Series miniature rail-mounted terminal blocks; suitable for 270 Series sensor and actuator terminal blocks; gray

1.2.5 Insulation stop

1.2.5.1 Insulation stop



Item No.: 2002-171

Insulation stop; 0.25 - 0.5 mm²; 5 pieces/strip; light gray



Item No.: 2002-172

Insulation stop; 0.75 - 1 mm²; 5 pieces/strip; dark gray

1.2.6 Jumper

1.2.6.1 Jumper



Item No.: 2004-406/020-000

Delta jumper; insulated; light gray



Item No.: 2004-410

Jumper; 10-way; insulated; light gray



Item No.: 2004-402

Jumper; 2-way; insulated; light gray



Item No.: 2004-403

Jumper; 3-way; insulated; light gray



Item No.: 2004-404

Jumper; 4-way; insulated; light gray



Item No.: 2004-405

Jumper; 5-way; insulated; light gray



Item No.: 2004-406

Jumper; 6-way; insulated; light gray



Item No.: 2004-407

Jumper; 7-way; insulated; light gray



Item No.: 2004-408

Jumper; 8-way; insulated; light gray



Item No.: 2004-409

Jumper; 9-way; insulated; light gray



Item No.: 2004-440

Jumper; from 1 to 10; insulated; light gray



Item No.: 2004-433

Jumper; from 1 to 3; insulated; light gray



Item No.: 2004-434

Jumper; from 1 to 4; insulated; light gray



Item No.: 2004-435

Jumper; from 1 to 5; insulated; light gray



Item No.: 2004-436

Jumper; from 1 to 6; insulated; light gray



Item No.: 2004-437

Jumper; from 1 to 7; insulated; light gray



Item No.: 2004-438

Jumper; from 1 to 8; insulated; light gray



Item No.: 2004-439

Jumper; from 1 to 9; insulated; light gray



Item No.: 2004-405/011-000

Star point jumper; 3-way; insulated; light gray



Item No.: 210-103

Wire commoning chain; insulated; black



Item No.: 210-123

Wire commoning chain; insulated; blue

1.2.7 Locking system

1.2.7.1 Locking system



Item No.: 210-254

Interlocking link; mechanically locks multiple links; 1 m long; transparent

1.2.8 Marking

1.2.8.1 Marker

Item No.: 2009-145/000-006

Mini-WSB Inline; for Smart Printer; 1700 pieces on roll; stretchable 5 - 5.2 mm; plain; snap-on type; blue

Item No.: 2009-145/000-007

Mini-WSB Inline; for Smart Printer; 1700 pieces on roll; stretchable 5 - 5.2 mm; plain; snap-on type; gray

Item No.: 2009-145/000-023

Mini-WSB Inline; for Smart Printer; 1700 pieces on roll; stretchable 5 - 5.2 mm; plain; snap-on type; green

Item No.: 2009-145/000-012

Mini-WSB Inline; for Smart Printer; 1700 pieces on roll; stretchable 5 - 5.2 mm; plain; snap-on type; orange

Item No.: 2009-145/000-005

Mini-WSB Inline; for Smart Printer; 1700 pieces on roll; stretchable 5 - 5.2 mm; plain; snap-on type; red

Item No.: 2009-145/000-024

Mini-WSB Inline; for Smart Printer; 1700 pieces on roll; stretchable 5 - 5.2 mm; plain; snap-on type; violet

Item No.: 2009-145

Mini-WSB Inline; for Smart Printer; 1700 pieces on roll; stretchable 5 - 5.2 mm; plain; snap-on type; white

Item No.: 2009-145/000-002

Mini-WSB Inline; for Smart Printer; 1700 pieces on roll; stretchable 5 - 5.2 mm; plain; snap-on type; yellow



Item No.: 248-501/000-006

Mini-WSB marking card; as card; not stretchable; plain; snap-on type; blue

Item No.: 248-501/000-007

Mini-WSB marking card; as card; not stretchable; plain; snap-on type; gray

Item No.: 248-501/000-023

Mini-WSB marking card; as card; not stretchable; plain; snap-on type; green

Item No.: 248-501/000-017

Mini-WSB marking card; as card; not stretchable; plain; snap-on type; light green



Item No.: 248-501/000-012

Mini-WSB marking card; as card; not stretchable; plain; snap-on type; orange

Item No.: 248-501/000-005

Mini-WSB marking card; as card; not stretchable; plain; snap-on type; red

Item No.: 248-501/000-024

Mini-WSB marking card; as card; not stretchable; plain; snap-on type; violet

Item No.: 248-501

Mini-WSB marking card; as card; not stretchable; plain; snap-on type; white



Item No.: 248-501/000-002

Mini-WSB marking card; as card; not stretchable; plain; snap-on type; yellow

Item No.: 793-5501/000-006

WMB marking card; as card; for terminal block width 5 - 17.5 mm; stretchable 5 - 5.2 mm; plain; snap-on type; blue

Item No.: 793-5501/000-014

WMB marking card; as card; for terminal block width 5 - 17.5 mm; stretchable 5 - 5.2 mm; plain; snap-on type; brown

Item No.: 793-5501/000-007

WMB marking card; as card; for terminal block width 5 - 17.5 mm; stretchable 5 - 5.2 mm; plain; snap-on type; gray



Item No.: 793-5501/000-023

WMB marking card; as card; for terminal block width 5 - 17.5 mm; stretchable 5 - 5.2 mm; plain; snap-on type; green

Item No.: 793-5501/000-017

WMB marking card; as card; for terminal block width 5 - 17.5 mm; stretchable 5 - 5.2 mm; plain; snap-on type; light green

Item No.: 793-5501/000-012

WMB marking card; as card; for terminal block width 5 - 17.5 mm; stretchable 5 - 5.2 mm; plain; snap-on type; orange

Item No.: 793-5501/000-005

WMB marking card; as card; for terminal block width 5 - 17.5 mm; stretchable 5 - 5.2 mm; plain; snap-on type; red



Item No.: 793-5501/000-024

WMB marking card; as card; for terminal block width 5 - 17.5 mm; stretchable 5 - 5.2 mm; plain; snap-on type; violet

Item No.: 793-5501

WMB marking card; as card; for terminal block width 5 - 17.5 mm; stretchable 5 - 5.2 mm; plain; snap-on type; white

Item No.: 793-5501/000-002

WMB marking card; as card; for terminal block width 5 - 17.5 mm; stretchable 5 - 5.2 mm; plain; snap-on type; yellow

Item No.: 2009-115/000-006

WMB-Inline; for Smart Printer; 1500 pieces on roll; stretchable 5 - 5.2 mm; plain; snap-on type; blue



Item No.: 2009-115/000-007

WMB-Inline; for Smart Printer; 1500 pieces on roll; stretchable 5 - 5.2 mm; plain; snap-on type; gray

Item No.: 2009-115/000-023

WMB-Inline; for Smart Printer; 1500 pieces on roll; stretchable 5 - 5.2 mm; plain; snap-on type; green

Item No.: 2009-115/000-017

WMB-Inline; for Smart Printer; 1500 pieces on roll; stretchable 5 - 5.2 mm; plain; snap-on type; light green

Item No.: 2009-115/000-012

WMB-Inline; for Smart Printer; 1500 pieces on roll; stretchable 5 - 5.2 mm; plain; snap-on type; orange



Item No.: 2009-115/000-005

WMB-Inline; for Smart Printer; 1500 pieces on roll; stretchable 5 - 5.2 mm; plain; snap-on type; red

Item No.: 2009-115/000-024

WMB-Inline; for Smart Printer; 1500 pieces on roll; stretchable 5 - 5.2 mm; plain; snap-on type; violet

Item No.: 2009-115

WMB-Inline; for Smart Printer; 1500 pieces on roll; stretchable 5 - 5.2 mm; plain; snap-on type; white

Item No.: 2009-115/000-002

WMB-Inline; for Smart Printer; 1500 pieces on roll; stretchable 5 - 5.2 mm; plain; snap-on type; yellow



1.2.8.2 Marking strip



Item No.: 2009-110

Marking strips; for Smart Printer; on reel; not stretchable; plain; snap-on type; white

1.2.9 Protective warning marker

1.2.9.1 Cover



Item No.: 2002-115

Protective warning marker; for 5 terminal blocks; with high-voltage symbol, black; yellow

1.2.10 Screwless end stop

1.2.10.1 Mounting accessories



Item No.: 249-117

Screwless end stop; 10 mm wide; for DIN-rail 35 x 15 and 35 x 7.5; gray



Item No.: 249-116

Screwless end stop; 6 mm wide; for DIN-rail 35 x 15 and 35 x 7.5; gray

1.2.11 Test and measurement

1.2.11.1 Testing accessories



Item No.: 210-136

Test plug; 2 mm Ø; with 500 mm cable; red

1.2.12 Tool

1.2.12.1 Operating tool



Item No.: 210-658

Operating tool; Blade: 3.5 x 0.5 mm; with a partially insulated shaft; angled; short; multicoloured



Item No.: 210-720

Operating tool; Blade: 3.5 x 0.5 mm; with a partially insulated shaft; multicoloured

Installation Notes

Conductor termination

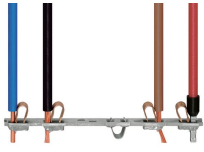

All conductor types at a glance

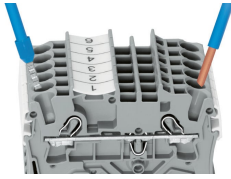

Push-in termination of solid and ferruled conductors

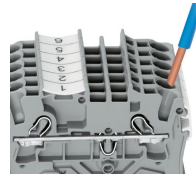

Inserting a conductor via push-in termination:
Solid conductors with cross-sections from either one size above, or up to two sizes below, the rated cross-section can be simply pushed in – no tools needed.

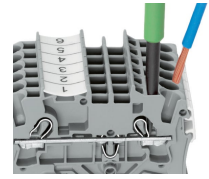

Inserting a conductor via operating tool:
Connecting fine-stranded conductors without ferrules, or small cross-sectional conductors that cannot be pushed in, is performed similarly to the original CAGE CLAMP® – just use an operating tool.
Advantage:
To open the clamp, the operating tool is inserted vertically. The conductor entry is less than 15 degrees for easier wiring.

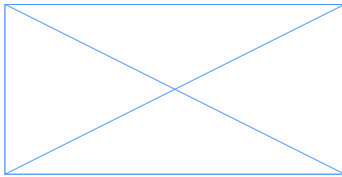

Conductor termination – insulation stop

Commoning

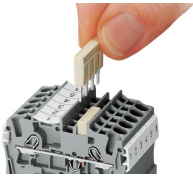

Insert push-in type jumper bar and push down until it hits backstop.

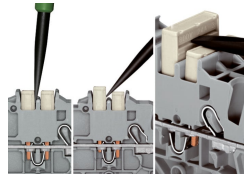

Removing a push-in type jumper bar:
Insert the operating tool between the jumper and partition wall of the dual jumper slots, then lift up the jumper.
Place the operating tool in the center of jumpers for up to five contacts (see above), or alternately on both sides for jumpers with more than five contacts.



Fuse terminal blocks with a width of 6.2 mm/0.244 in can be assembled adjacently. If there is no adjacent fuse terminal block at the end of the assembly, an end plate must be used.

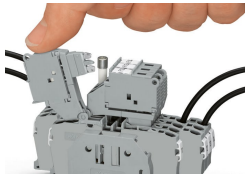

Fused Disconnect Terminal Block with a Pivoting Fuse Holder
Pivot the fuse holder into the locked open position.

Fused disconnect terminal block with a pivoting fuse holder
Fuse replacement

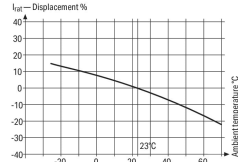
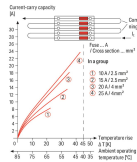
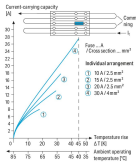

Information from the mini-automotive, blade-type fuse manufacturers

Standard	%	F_1
15	14	0.877
15	15	0.884
15	17	0.893
15	20	0.903
15	25	0.914
15	30	0.925
15	35	0.936
15	40	0.947
15	45	0.958
15	50	0.969
15	55	0.980
15	60	0.991
15	65	1.002
15	70	1.013
15	75	1.024
15	80	1.035
15	85	1.046
15	90	1.057
15	95	1.068
15	100	1.079
15	105	1.090
15	110	1.101
15	115	1.112
15	120	1.123
15	125	1.134
15	130	1.145
15	135	1.156
15	140	1.167
15	145	1.178
15	150	1.189
15	155	1.200
15	160	1.211
15	165	1.222
15	170	1.233
15	175	1.244
15	180	1.255
15	185	1.266
15	190	1.277
15	195	1.288
15	200	1.299
15	205	1.310
15	210	1.321
15	215	1.332
15	220	1.343
15	225	1.354
15	230	1.365
15	235	1.376
15	240	1.387
15	245	1.398
15	250	1.409
15	255	1.420
15	260	1.431
15	265	1.442
15	270	1.453
15	275	1.464
15	280	1.475
15	285	1.486
15	290	1.497
15	295	1.508
15	300	1.519
15	305	1.530
15	310	1.541
15	315	1.552
15	320	1.563
15	325	1.574
15	330	1.585
15	335	1.596
15	340	1.607
15	345	1.618
15	350	1.629
15	355	1.640
15	360	1.651
15	365	1.662
15	370	1.673
15	375	1.684
15	380	1.695
15	385	1.706
15	390	1.717
15	395	1.728
15	400	1.739
15	405	1.750
15	410	1.761
15	415	1.772
15	420	1.783
15	425	1.794
15	430	1.805
15	435	1.816
15	440	1.827
15	445	1.838
15	450	1.849
15	455	1.860
15	460	1.871
15	465	1.882
15	470	1.893
15	475	1.904
15	480	1.915
15	485	1.926
15	490	1.937
15	495	1.948
15	500	1.959
15	505	1.970
15	510	1.981
15	515	1.992
15	520	2.003
15	525	2.014
15	530	2.025
15	535	2.036
15	540	2.047
15	545	2.058
15	550	2.069
15	555	2.080
15	560	2.091
15	565	2.102
15	570	2.113
15	575	2.124
15	580	2.135
15	585	2.146
15	590	2.157
15	595	2.168
15	600	2.179
15	605	2.190
15	610	2.201
15	615	2.212
15	620	2.223
15	625	2.234
15	630	2.245
15	635	2.256
15	640	2.267
15	645	2.278
15	650	2.289
15	655	2.300
15	660	2.311
15	665	2.322
15	670	2.333
15	675	2.344
15	680	2.355
15	685	2.366
15	690	2.377
15	695	2.388
15	700	2.399
15	705	2.410
15	710	2.421
15	715	2.432
15	720	2.443
15	725	2.454
15	730	2.465
15	735	2.476
15	740	2.487
15	745	2.498
15	750	2.509
15	755	2.520
15	760	2.531
15	765	2.542
15	770	2.553
15	775	2.564
15	780	2.575
15	785	2.586
15	790	2.597
15	795	2.608
15	800	2.619
15	805	2.630
15	810	2.641
15	815	2.652
15	820	2.663
15	825	2.674
15	830	2.685
15	835	2.696
15	840	2.707
15	845	2.718
15	850	2.729
15	855	2.740
15	860	2.751
15	865	2.762
15	870	2.773
15	875	2.784
15	880	2.795
15	885	2.806
15	890	2.817
15	895	2.828
15	900	2.839
15	905	2.850
15	910	2.861
15	915	2.872
15	920	2.883
15	925	2.894
15	930	2.905
15	935	2.916
15	940	2.927
15	945	2.938
15	950	2.949
15	955	2.960
15	960	2.971
15	965	2.982
15	970	2.993
15	975	3.004
15	980	3.015
15	985	3.026
15	990	3.037
15	995	3.048
15	1000	3.059

Application Notes on Terminal Blocks for Glass Cartridge Fuses
Diagram: "Individual Arrangement"

Application Notes on Terminal Blocks for Glass Cartridge Fuses
Diagram: "Block Arrangement"

Application Notes on Terminal Blocks for Glass Cartridge Fuses
Nominal current ratings for fuse cartridges are defined differently in international standards. This is why the recommended continuous current-carrying capacity of the fuses is a max. 80% of their nominal current according to DIN 72581/Part 3 (for a surrounding air temperature of 23°C).
Selecting the correct fuse cartridge is important for product safety within applications, as well as for fuse cartridge service life and reliability. Fuse cartridges will only operate perfectly as protection components (break-off point) if they are properly selected and used as intended (i.e., according to the state of the technology and valid specifications, as well as data sheet characteristics), according to basic safety requirements (i.e., persons, animals and property must be protected against hazards).

Concerning product safety, fuse cartridges must generally be tested under both normal and faulty operating conditions within your application.

Marking

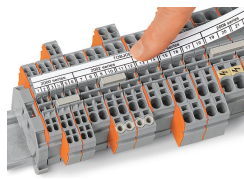
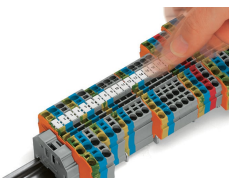

Snapping WMB Inline markers into marker slots.