

## Data Sheet | Item Number: 2202-1601

2-conductor through terminal block; with push-button; 2.5 mm<sup>2</sup>; with test option; same profile as 2-conductor disconnect terminal block; side and center marking; for DIN-rail 35 x 15 and 35 x 7.5; Push-in CAGE CLAMP®; 2,50 mm<sup>2</sup>; gray

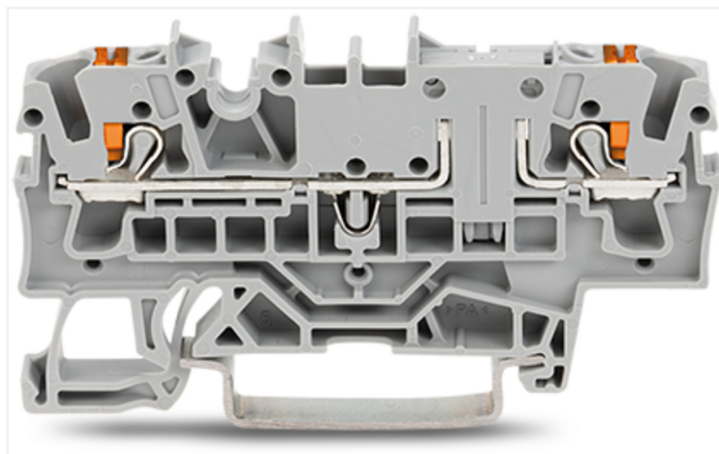

<https://www.wago.com/2202-1601>

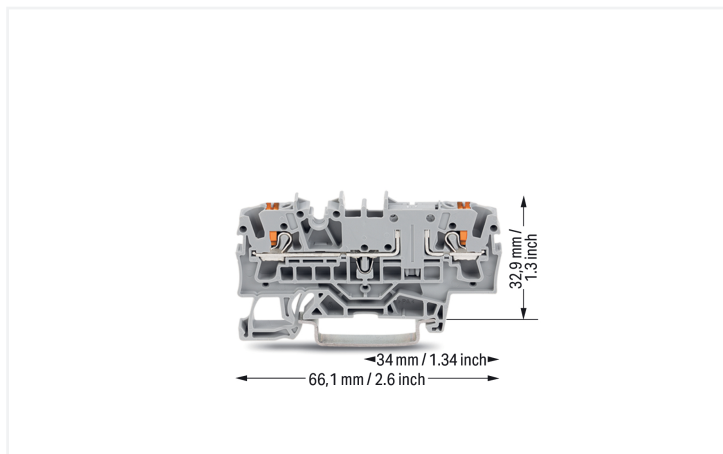

Color: ■ gray



Similar to illustration

### Through terminal block, 2202 Series, Push-in CAGE CLAMP®

Our through terminal block (item number 2202-1601) ensures effortless electrical installations. Conductors should only be connected to this through terminal block if their strip length is between 10 and 12 mm. Featuring conductor terminals along with Push-in CAGE CLAMP®, this product outperforms the competition. Our Push-in CAGE CLAMP® is a universal, maintenance-free connection solution for all conductor types, offering a key advantage: It allows direct insertion of both solid and fine-stranded conductors with ferrules without needing tools. No preparation is required; for example, crimping the conductor's ferrule is not necessary. The dimensions are (5.2 x 66.1 x 39.5) mm (width x height x depth). This through terminal block is suitable for conductor cross sections ranging from 0.25 mm<sup>2</sup> to 4 mm<sup>2</sup>.

This product is designed for specific Ex applications (please refer to the product datasheet).

## Notes

## Safety Information

The 2 mm test slot is only approved for high impedance measurement up to max. 100 mA.

## Electrical data

Ratings per	IEC/EN 60947-7-1		
Overvoltage category	III	III	II
Pollution degree	3	2	2
Nominal voltage	400 V	-	-
Rated impulse withstand voltage	6 kV	-	-
Rated current	16 A	-	-

Approvals per	UL 1059		
Use group	B	C	D
Rated voltage	300 V	300 V	-
Rated current	15 A	15 A	-

Approvals per	CSA 22.2 No 158		
Use group	B	C	D
Rated voltage	300 V	300 V	-
Rated current	15 A	15 A	-

Ex information	
Reference to hazardous areas	See "Downloads – Documentation – Additional Information: Technical Section; Technical Explanations"
Ratings per	ATEX: PTB 20 ATEX 1007 U / IECEx: PTB 20.0013U (Ex ec IIC Gc)
Rated voltage EN (Ex e II)	440 V
Rated current (Ex e II)	17 A

## Power Loss

Power loss, per pole (potential)	0.3405 W
Rated current $I_N$ for power loss specification	16 A
Resistance value for specified, current-dependent power loss	0.00133 $\Omega$

## General information

Wiring direction	Front-entry wiring
------------------	--------------------

## Connection Data

Clamping units	2
Total number of potentials	1
Number of levels	1
Number of jumper slots	2

## Connection 1

Connection technology	Push-in CAGE CLAMP®
Actuation type	Push-button
Connectable conductor materials	Copper
Nominal cross-section	2.5 mm <sup>2</sup>
Solid conductor	0.25 ... 4 mm <sup>2</sup> / 22 ... 12 AWG
Solid conductor; push-in termination	0.75 ... 4 mm <sup>2</sup> / 18 ... 12 AWG
Fine-stranded conductor	0.25 ... 4 mm <sup>2</sup> / 22 ... 12 AWG
Fine-stranded conductor; with insulated ferrule	0.25 ... 2.5 mm <sup>2</sup> / 22 ... 14 AWG
Fine-stranded conductor; with ferrule; push-in termination	1 ... 2.5 mm <sup>2</sup> / 18 ... 14 AWG
Note (conductor cross-section)	Depending on the conductor characteristic, a conductor with a smaller cross-section can also be inserted via push-in termination.
Strip length	10 ... 12 mm / 0.39 ... 0.47 inches
Wiring direction	Front-entry wiring

### Physical data

Width	5.2 mm / 0.205 inches
Height	66.1 mm / 2.602 inches
Depth from upper-edge of DIN-rail	32.9 mm / 1.295 inches
Depth	39.5 mm / 1.555 inches

### Mechanical data

Mounting type	DIN-35 rail
Marking level	Center/side marking

### Material data

Note (material data)	<a href="#">Information on material specifications can be found here</a>
Color	gray
Material group	I
Insulation material (main housing)	Polyamide (PA66)
Flammability class per UL94	V0
Fire load	0.181 MJ
Actuator color	orange
Weight	7.9 g

### Environmental requirements

Processing temperature	-35 ... +85 °C
Continuous operating temperature	-60 ... +105 °C

### Commercial data

PU (SPU)	50 pcs
Packaging type	Box
Country of origin	DE
GTIN	4055143907576
Customs tariff number	85369010000

### Product Classification

UNSPSC	39121410
ETIM 9.0	EC000897
ETIM 10.0	EC000897
ECCN	NO US CLASSIFICATION

### Environmental Product Compliance

RoHS Compliance Status	Compliant, No Exemption
------------------------	-------------------------

Approvals / Certificates

General approvals



Approval	Standard	Certificate Name
DEKRA DEKRA Certification B.V.	EN 60947	71-147887
UL Underwriters Laboratories Inc.	UL 1059	UL-CA- L45172-6189178-11508102-1

Declarations of conformity and manufacturer's declarations

Approval	Standard	Certificate Name
ATEX-Attestation of Conformity WAGO GmbH & Co. KG	-	-
EU-Declaration of Conformity WAGO GmbH & Co. KG	-	-
UK-Declaration of Conformity WAGO GmbH & Co. KG	-	-

Approvals for hazardous areas



Approval	Standard	Certificate Name
AEx Underwriters Laboratories Inc.	UL 60079	E185892 (AEx eb IIC resp. Ex eb IIC)
ATEX Physikalisch Technische Bundesanstalt	EN IEC 60079-0	PTB 20 ATEX 1007U (II 3 G Ex ec IIC Gc)
CCC CNEX	-	2020312313000288 (Ex ec IIC Gc)
IECEX Physikalisch Technische Bundesanstalt	IEC 60079	IECEX PTB 20.0013U (Ex ec IIC Gc)

Downloads

Environmental Product Compliance

Compliance Search

Environmental Product Compliance 2202-1601	<a href="#">↓</a>
--	-------------------

Documentation

Bid Text

2202-1601	20.05.2019	xml 4.06 KB	<a href="#">↓</a>
2202-1601	20.05.2019	docx 14.88 KB	<a href="#">↓</a>

CAD/CAE-Data

CAD data

2D/3D Models  
2202-1601



1 Compatible Products

1.1 Required Accessories

1.1.1 End plate

1.1.1.1 End plate



[Item No.: 2002-1691](#)

End and intermediate plate; 1 mm thick; gray



[Item No.: 2002-1692](#)

End and intermediate plate; 1 mm thick; orange



[Item No.: 209-191](#)

Separator for Ex e/Ex i applications; 3 mm thick; 120 mm wide; orange

1.2 Optional Accessories

1.2.1 DIN-rail

1.2.1.1 Mounting accessories



[Item No.: 210-196](#)

Aluminum carrier rail; 35 x 8.2 mm; 1.6 mm thick; 2 m long; unslotted; similar to EN 60715; silver-colored



[Item No.: 210-198](#)

Copper carrier rail; 35 x 15 mm; 2.3 mm thick; 2 m long; unslotted; according to EN 60715; copper-colored



[Item No.: 210-508](#)

Steel carrier rail; 35 x 15 mm; 1.5 mm thick; 2 m long; slotted; galvanized; similar to EN 60715; silver-colored



[Item No.: 210-197](#)

Steel carrier rail; 35 x 15 mm; 1.5 mm thick; 2 m long; slotted; similar to EN 60715; silver-colored



[Item No.: 210-506](#)

Steel carrier rail; 35 x 15 mm; 1.5 mm thick; 2 m long; unslotted; galvanized; similar to EN 60715; silver-colored



[Item No.: 210-114](#)

Steel carrier rail; 35 x 15 mm; 1.5 mm thick; 2 m long; unslotted; similar to EN 60715; silver-colored



[Item No.: 210-118](#)

Steel carrier rail; 35 x 15 mm; 2.3 mm thick; 2 m long; unslotted; according to EN 60715; silver-colored



[Item No.: 210-115](#)

Steel carrier rail; 35 x 7.5 mm; 1 mm thick; 2 m long; slotted; according to EN 60715; "Hole width 18 mm; silver-colored



[Item No.: 210-112](#)

Steel carrier rail; 35 x 7.5 mm; 1 mm thick; 2 m long; slotted; according to EN 60715; "Hole width 25 mm; silver-colored



[Item No.: 210-504](#)

Steel carrier rail; 35 x 7.5 mm; 1 mm thick; 2 m long; slotted; galvanized; according to EN 60715; silver-colored



[Item No.: 210-113](#)

Steel carrier rail; 35 x 7.5 mm; 1 mm thick; 2 m long; unslotted; according to EN 60715; silver-colored



[Item No.: 210-505](#)

Steel carrier rail; 35 x 7.5 mm; 1 mm thick; 2 m long; unslotted; galvanized; according to EN 60715; silver-colored

1.2.2 Ferrule

1.2.2.1 Ferrule



[Item No.: 216-241](#)

Ferrule; Sleeve for 0.5 mm<sup>2</sup> / 20 AWG; insulated; electro-tin plated; electrolytic copper; gastight crimped; acc. to DIN 46228, Part 4/09.90; white



[Item No.: 216-242](#)

Ferrule; Sleeve for 0.75 mm<sup>2</sup> / 18 AWG; insulated; electro-tin plated; electrolytic copper; gastight crimped; acc. to DIN 46228, Part 4/09.90; gray



[Item No.: 216-262](#)

Ferrule; Sleeve for 0.75 mm<sup>2</sup> / 18 AWG; insulated; electro-tin plated; electrolytic copper; gastight crimped; acc. to DIN 46228, Part 4/09.90; gray



[Item No.: 216-243](#)

Ferrule; Sleeve for 1 mm<sup>2</sup> / AWG 18; insulated; electro-tin plated; electrolytic copper; gastight crimped; acc. to DIN 46228, Part 4/09.90; red



[Item No.: 216-263](#)

Ferrule; Sleeve for 1 mm<sup>2</sup> / AWG 18; insulated; electro-tin plated; electrolytic copper; gastight crimped; acc. to DIN 46228, Part 4/09.90; red



[Item No.: 216-244](#)

Ferrule; Sleeve for 1.5 mm<sup>2</sup> / AWG 16; insulated; electro-tin plated; electrolytic copper; gastight crimped; acc. to DIN 46228, Part 4/09.90; black



[Item No.: 216-264](#)

Ferrule; Sleeve for 1.5 mm<sup>2</sup> / AWG 16; insulated; electro-tin plated; electrolytic copper; gastight crimped; acc. to DIN 46228, Part 4/09.90; black



[Item No.: 216-246](#)

Ferrule; Sleeve for 2.5 mm<sup>2</sup> / AWG 14; insulated; electro-tin plated; electrolytic copper; gastight crimped; acc. to DIN 46228, Part 4/09.90; blue

1.2.2.1 Ferrule



**Item No.: 216-266**  
 Ferrule; Sleeve for 2.5 mm<sup>2</sup> / AWG 14; insulated; electro-tin plated; electrolytic copper; gastight crimped; acc. to DIN 46228, Part 4/09.90; blue

1.2.3 Installation

1.2.3.1 Cover



**Item No.: 709-156**  
 Cover; Type 3; suitable for cover carrier, type 3; 1 m long; transparent

1.2.3.2 Cover carrier



**Item No.: 709-169**  
 Cover carrier; Type 3; incl. fixing/retaining screws and knurled nut; suitable for 279 to 282 and 880 Series rail-mounted terminal blocks; suitable for 264 Series miniature rail-mounted terminal blocks; suitable for 270 Series sensor and actuator terminal blocks; gray

1.2.4 Insulation stop

1.2.4.1 Insulation stop



**Item No.: 2002-171**  
 Insulation stop; 0.25 - 0.5 mm<sup>2</sup>; 5 pieces/strip; light gray



**Item No.: 2002-172**  
 Insulation stop; 0.75 - 1 mm<sup>2</sup>; 5 pieces/strip; dark gray

1.2.5 Jumper

1.2.5.1 Jumper



**Item No.: 2002-400**  
 Continuous jumper; 2-way; insulated; light gray



**Item No.: 2002-413**  
 Continuous jumper; 3-way; insulated; light gray



**Item No.: 2002-415**  
 Continuous jumper; 5-way; insulated; light gray



**Item No.: 2002-423/000-006**  
 Continuous jumper; from 1 to 3; insulated; blue



**Item No.: 2002-423**  
 Continuous jumper; from 1 to 3; insulated; light gray



**Item No.: 2002-423/000-005**  
 Continuous jumper; from 1 to 3; insulated; red



**Item No.: 2002-424/000-006**  
 Continuous jumper; from 1 to 4; insulated; blue



**Item No.: 2002-424**  
 Continuous jumper; from 1 to 4; insulated; light gray



**Item No.: 2002-424/000-005**  
 Continuous jumper; from 1 to 4; insulated; red



**Item No.: 2002-406/020-000**  
 Delta jumper; insulated; light gray























































**Item No.: 2002-410/000-006**  
 Jumper; 10-way; insulated; blue



**Item No.: 2002-410**  
 Jumper; 10-way; insulated; light gray

1.2.5.1 Jumper

 <a href="#">Item No.: 2002-410/000-005</a> Jumper; 10-way; insulated; red	 <a href="#">Item No.: 2002-402/000-006</a> Jumper; 2-way; insulated; blue	 <a href="#">Item No.: 2002-402</a> Jumper; 2-way; insulated; light gray	 <a href="#">Item No.: 2002-402/000-005</a> Jumper; 2-way; insulated; red
 <a href="#">Item No.: 2002-403/000-006</a> Jumper; 3-way; insulated; blue	 <a href="#">Item No.: 2002-403</a> Jumper; 3-way; insulated; light gray	 <a href="#">Item No.: 2002-403/000-005</a> Jumper; 3-way; insulated; red	 <a href="#">Item No.: 2002-404/000-006</a> Jumper; 4-way; insulated; blue
 <a href="#">Item No.: 2002-404</a> Jumper; 4-way; insulated; light gray	 <a href="#">Item No.: 2002-404/000-005</a> Jumper; 4-way; insulated; red	 <a href="#">Item No.: 2002-405/000-006</a> Jumper; 5-way; insulated; blue	 <a href="#">Item No.: 2002-405</a> Jumper; 5-way; insulated; light gray
 <a href="#">Item No.: 2002-405/000-005</a> Jumper; 5-way; insulated; red	 <a href="#">Item No.: 2002-406/000-006</a> Jumper; 6-way; insulated; blue	 <a href="#">Item No.: 2002-406</a> Jumper; 6-way; insulated; light gray	 <a href="#">Item No.: 2002-406/000-005</a> Jumper; 6-way; insulated; red
 <a href="#">Item No.: 2002-407/000-006</a> Jumper; 7-way; insulated; blue	 <a href="#">Item No.: 2002-407</a> Jumper; 7-way; insulated; light gray	 <a href="#">Item No.: 2002-407/000-005</a> Jumper; 7-way; insulated; red	 <a href="#">Item No.: 2002-408/000-006</a> Jumper; 8-way; insulated; blue
 <a href="#">Item No.: 2002-408</a> Jumper; 8-way; insulated; light gray	 <a href="#">Item No.: 2002-408/000-005</a> Jumper; 8-way; insulated; red	 <a href="#">Item No.: 2002-409/000-006</a> Jumper; 9-way; insulated; blue	 <a href="#">Item No.: 2002-409</a> Jumper; 9-way; insulated; light gray
 <a href="#">Item No.: 2002-409/000-005</a> Jumper; 9-way; insulated; red	 <a href="#">Item No.: 2002-440</a> Jumper; from 1 to 10; insulated; light gray	 <a href="#">Item No.: 2002-433</a> Jumper; from 1 to 3; insulated; light gray	 <a href="#">Item No.: 2002-434</a> Jumper; from 1 to 4; insulated; light gray
 <a href="#">Item No.: 2002-435</a> Jumper; from 1 to 5; insulated; light gray	 <a href="#">Item No.: 2002-436</a> Jumper; from 1 to 6; insulated; light gray	 <a href="#">Item No.: 2002-437</a> Jumper; from 1 to 7; insulated; light gray	 <a href="#">Item No.: 2002-438</a> Jumper; from 1 to 8; insulated; light gray
 <a href="#">Item No.: 2002-439</a> Jumper; from 1 to 9; insulated; light gray	 <a href="#">Item No.: 2002-480</a> Staggered jumper; 10-way; insulated; light gray	 <a href="#">Item No.: 2002-481</a> Staggered jumper; 11-way; insulated; light gray	 <a href="#">Item No.: 2002-482</a> Staggered jumper; 12-way; insulated; light gray
 <a href="#">Item No.: 2002-473/011-000</a> Staggered jumper; 2-way; from 1 to 3; insulated; light gray	 <a href="#">Item No.: 2002-472</a> Staggered jumper; 2-way; insulated; light gray	 <a href="#">Item No.: 2002-473</a> Staggered jumper; 3-way; insulated; light gray	 <a href="#">Item No.: 2002-475/011-000</a> Staggered jumper; 3-way; insulated; light gray
 <a href="#">Item No.: 2002-474</a> Staggered jumper; 4-way; insulated; light gray	 <a href="#">Item No.: 2002-475</a> Staggered jumper; 5-way; insulated; light gray	 <a href="#">Item No.: 2002-476</a> Staggered jumper; 6-way; insulated; light gray	 <a href="#">Item No.: 2002-477</a> Staggered jumper; 7-way; insulated; light gray
 <a href="#">Item No.: 2002-478</a> Staggered jumper; 8-way; insulated; light gray	 <a href="#">Item No.: 2002-479</a> Staggered jumper; 9-way; insulated; light gray	 <a href="#">Item No.: 2002-477/011-000</a> Staggered jumper; insulated; light gray	 <a href="#">Item No.: 2002-479/011-000</a> Staggered jumper; insulated; light gray
 <a href="#">Item No.: 2002-481/011-000</a> Staggered jumper; insulated; light gray	 <a href="#">Item No.: 2002-405/011-000</a> Star point jumper; 3-way; insulated; light gray	 <a href="#">Item No.: 210-103</a> Wire commoning chain; insulated; black	 <a href="#">Item No.: 210-123</a> Wire commoning chain; insulated; blue

1.2.6 Marking

1.2.6.1 Group marker carrier



Item No.: 2009-191

Group marker carrier; gray

Item No.: 2009-192

Group marker carrier; gray

Item No.: 2009-193

Group marker carrier; gray

1.2.6.2 Marker

Item No.: 2009-145/000-006

Mini-WSB Inline; for Smart Printer; 1700 pieces on roll; stretchable 5 - 5.2 mm; plain; snap-on type; blue

Item No.: 2009-145/000-007

Mini-WSB Inline; for Smart Printer; 1700 pieces on roll; stretchable 5 - 5.2 mm; plain; snap-on type; gray

Item No.: 2009-145/000-023

Mini-WSB Inline; for Smart Printer; 1700 pieces on roll; stretchable 5 - 5.2 mm; plain; snap-on type; green

Item No.: 2009-145/000-012

Mini-WSB Inline; for Smart Printer; 1700 pieces on roll; stretchable 5 - 5.2 mm; plain; snap-on type; orange

Item No.: 2009-145/000-005

Mini-WSB Inline; for Smart Printer; 1700 pieces on roll; stretchable 5 - 5.2 mm; plain; snap-on type; red

Item No.: 2009-145/000-024

Mini-WSB Inline; for Smart Printer; 1700 pieces on roll; stretchable 5 - 5.2 mm; plain; snap-on type; violet

Item No.: 2009-145

Mini-WSB Inline; for Smart Printer; 1700 pieces on roll; stretchable 5 - 5.2 mm; plain; snap-on type; white

Item No.: 2009-145/000-002

Mini-WSB Inline; for Smart Printer; 1700 pieces on roll; stretchable 5 - 5.2 mm; plain; snap-on type; yellow



Item No.: 248-501/000-006

Mini-WSB marking card; as card; not stretchable; plain; snap-on type; blue

Item No.: 248-501/000-007

Mini-WSB marking card; as card; not stretchable; plain; snap-on type; gray

Item No.: 248-501/000-023

Mini-WSB marking card; as card; not stretchable; plain; snap-on type; green

Item No.: 248-501/000-017

Mini-WSB marking card; as card; not stretchable; plain; snap-on type; light green



Item No.: 248-501/000-012

Mini-WSB marking card; as card; not stretchable; plain; snap-on type; orange

Item No.: 248-501/000-005

Mini-WSB marking card; as card; not stretchable; plain; snap-on type; red

Item No.: 248-501/000-024

Mini-WSB marking card; as card; not stretchable; plain; snap-on type; violet

Item No.: 248-501

Mini-WSB marking card; as card; not stretchable; plain; snap-on type; white



Item No.: 248-501/000-002

Mini-WSB marking card; as card; not stretchable; plain; snap-on type; yellow

Item No.: 793-5501/000-006

WMB marking card; as card; for terminal block width 5 - 17.5 mm; stretchable 5 - 5.2 mm; plain; snap-on type; blue

Item No.: 793-5501/000-014

WMB marking card; as card; for terminal block width 5 - 17.5 mm; stretchable 5 - 5.2 mm; plain; snap-on type; brown

Item No.: 793-5501/000-007

WMB marking card; as card; for terminal block width 5 - 17.5 mm; stretchable 5 - 5.2 mm; plain; snap-on type; gray



Item No.: 793-5501/000-023

WMB marking card; as card; for terminal block width 5 - 17.5 mm; stretchable 5 - 5.2 mm; plain; snap-on type; green

Item No.: 793-5501/000-017

WMB marking card; as card; for terminal block width 5 - 17.5 mm; stretchable 5 - 5.2 mm; plain; snap-on type; light green

Item No.: 793-5501/000-012

WMB marking card; as card; for terminal block width 5 - 17.5 mm; stretchable 5 - 5.2 mm; plain; snap-on type; orange

Item No.: 793-5501/000-005

WMB marking card; as card; for terminal block width 5 - 17.5 mm; stretchable 5 - 5.2 mm; plain; snap-on type; red



Item No.: 793-5501/000-024

WMB marking card; as card; for terminal block width 5 - 17.5 mm; stretchable 5 - 5.2 mm; plain; snap-on type; violet

Item No.: 793-5501

WMB marking card; as card; for terminal block width 5 - 17.5 mm; stretchable 5 - 5.2 mm; plain; snap-on type; white

Item No.: 793-5501/000-002

WMB marking card; as card; for terminal block width 5 - 17.5 mm; stretchable 5 - 5.2 mm; plain; snap-on type; yellow

Item No.: 2009-115/000-006

WMB-Inline; for Smart Printer; 1500 pieces on roll; stretchable 5 - 5.2 mm; plain; snap-on type; blue



Item No.: 2009-115/000-007

WMB-Inline; for Smart Printer; 1500 pieces on roll; stretchable 5 - 5.2 mm; plain; snap-on type; gray

Item No.: 2009-115/000-023

WMB-Inline; for Smart Printer; 1500 pieces on roll; stretchable 5 - 5.2 mm; plain; snap-on type; green

Item No.: 2009-115/000-017

WMB-Inline; for Smart Printer; 1500 pieces on roll; stretchable 5 - 5.2 mm; plain; snap-on type; light green

Item No.: 2009-115/000-012

WMB-Inline; for Smart Printer; 1500 pieces on roll; stretchable 5 - 5.2 mm; plain; snap-on type; orange



Item No.: 2009-115/000-005

WMB-Inline; for Smart Printer; 1500 pieces on roll; stretchable 5 - 5.2 mm; plain; snap-on type; red

Item No.: 2009-115/000-024

WMB-Inline; for Smart Printer; 1500 pieces on roll; stretchable 5 - 5.2 mm; plain; snap-on type; violet

Item No.: 2009-115

WMB-Inline; for Smart Printer; 1500 pieces on roll; stretchable 5 - 5.2 mm; plain; snap-on type; white

Item No.: 2009-115/000-002

WMB-Inline; for Smart Printer; 1500 pieces on roll; stretchable 5 - 5.2 mm; plain; snap-on type; yellow

1.2.6.3 Marker carrier



**Item No.: 2002-121**  
Adaptor; gray

**Item No.: 2002-161**  
Adaptor; gray

**Item No.: 2009-198**  
Adaptor; gray

1.2.6.4 Marking strip



**Item No.: 2009-110**  
Marking strips; for Smart Printer; on reel; not stretchable; plain; snap-on type; white

1.2.7 Plug

1.2.7.1 Component module with diode



**Item No.: 2002-880/1000-411**  
Component plug; 2-pole; with diode 1N4007; 10.4 mm wide; Operating temperature 85°C max.; gray

1.2.7.2 Component module with LED



**Item No.: 2002-880/1000-541**  
Component plug; 2-pole; LED (red); 10.4 mm wide; Operating temperature 85°C max.; gray



**Item No.: 2002-880/1000-836**  
Component plug; 2-pole; LED (red); 10.4 mm wide; Operating temperature 85°C max.; gray



**Item No.: 2002-880/1000-542**  
Component plug; 2-pole; LED (red); 10.4 mm wide; Operating temperature 85°C max.; multicoloured

1.2.7.3 Empty component plug housing



**Item No.: 2002-880**  
Empty component plug housing; 10.4 mm wide; 2-pole; Type 4; gray

1.2.8 Push-in type wire jumper

1.2.8.1 Jumper



**Item No.: 2009-414**  
Push-in type wire jumper; 1.5 mm<sup>2</sup>; insulated; 110 mm long; black



**Item No.: 2009-414/000-005**  
Push-in type wire jumper; 1.5 mm<sup>2</sup>; insulated; 110 mm long; black



**Item No.: 2009-416**  
Push-in type wire jumper; 1.5 mm<sup>2</sup>; insulated; 250 mm long; black



**Item No.: 2009-414/000-006**  
Push-in type wire jumper; insulated; 110 mm long; black



**Item No.: 2009-412**  
Push-in type wire jumper; insulated; 60 mm long; black

## 1.2.9 Screwless end stop

### 1.2.9.1 Mounting accessories



**Item No.: 249-117**

Screwless end stop; 10 mm wide; for DIN-rail 35 x 15 and 35 x 7.5; gray



**Item No.: 249-116**

Screwless end stop; 6 mm wide; for DIN-rail 35 x 15 and 35 x 7.5; gray

## 1.2.10 Test and measurement

### 1.2.10.1 Testing accessories



**Item No.: 2002-560**

Modular TOPJOB®S connector; modular; for jumper contact slot; 10-pole; gray



**Item No.: 2002-511**

Modular TOPJOB®S connector; modular; for jumper contact slot; 1-pole; gray



**Item No.: 2002-552**

Modular TOPJOB®S connector; modular; for jumper contact slot; 2-pole; gray



**Item No.: 2002-553**

Modular TOPJOB®S connector; modular; for jumper contact slot; 3-pole; gray



**Item No.: 2002-554**

Modular TOPJOB®S connector; modular; for jumper contact slot; 4-pole; gray



**Item No.: 2002-555**

Modular TOPJOB®S connector; modular; for jumper contact slot; 5-pole; gray



**Item No.: 2002-556**

Modular TOPJOB®S connector; modular; for jumper contact slot; 6-pole; gray



**Item No.: 2002-557**

Modular TOPJOB®S connector; modular; for jumper contact slot; 7-pole; gray



**Item No.: 2002-558**

Modular TOPJOB®S connector; modular; for jumper contact slot; 8-pole; gray



**Item No.: 2002-559**

Modular TOPJOB®S connector; modular; for jumper contact slot; 9-pole; gray



**Item No.: 2002-549**

Spacer module; modular; e.g., for bridging commoned terminal blocks; gray



**Item No.: 2009-174**

Test plug adapter; for 4 mm Ø test plugs; for testing TOPJOB®S rail-mounted terminal blocks; gray



**Item No.: 210-136**

Test plug; 2 mm Ø; with 500 mm cable; red



**Item No.: 2009-182**

Testing tap; for max. 2.5 mm<sup>2</sup>; tool-free connection for individual test wires 0.08 - 2.5 mm; gray



**Item No.: 2002-649**

TOPJOB®S L-type spacer module; modular; e.g., for bridging commoned terminal blocks; gray

## 1.2.11 Tool

### 1.2.11.1 Operating tool



**Item No.: 210-658**

Operating tool; Blade: 3.5 x 0.5 mm; with a partially insulated shaft; angled; short; multicoloured



**Item No.: 210-720**

Operating tool; Blade: 3.5 x 0.5 mm; with a partially insulated shaft; multicoloured

## Installation Notes

### Conductor termination

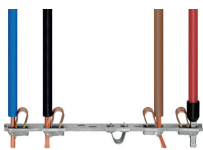

All conductor types at a glance



Push-in termination of solid and ferruled conductors



Insert fine-stranded conductors via operating tool.

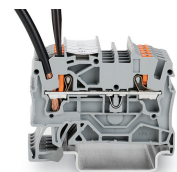

Removing all conductors via operating tool.

## Commoning

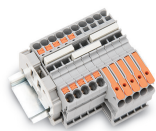

Insert a push-in type jumper bar and push down until it hits the backstop.

Commoning with step-down jumpers.

## Testing



Testing with a 2 mm Ø test plug (max. 42 V).

## Marking

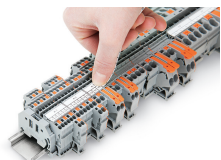

Snapping a marking strip into a marker slot.

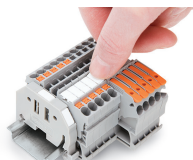

Snapping a marking strip into the marker slot.