



Features

- Compact and elegant design Suitable replacement for halogen, incandescent and compact fluorescent candle lamps Instant light at the flick of a switch Uniform light distribution Good colour rendering (CRI 80) Perfect for hotels, restaurants, lobbies, corridors, stairwells, reception areas Lower maintenance costs 15,000 hours average rated life

Product Overview

Product name	ToLEDo Candle V7 470LM 827 E14 SL
Technology	LED
Watt (Rated) (W)	4.5
Cap/Base	E14
Fixture rating	Open
General application	Hospitality, Residential & Consumer
ETIM Class	EC001959
E-number FI	4740997
Correlated colour temperature (k)	2700
Light colour	Homelight
CRI (Ra)	80
Colour Variation Initial (SDCM)	6
Photobiological Risk Group	RG0
Wattage (W)	4.5
Power consumption (W)	4.5
Dimmable	No
Average life (Nominal) (h)	15000
Product EAN number	5410288296074

ToLEDo Candle V7 470LM 827 E14 SL 0029607

Warranty	3 years
Useful luminous flux (#use)	470

Technical drawings

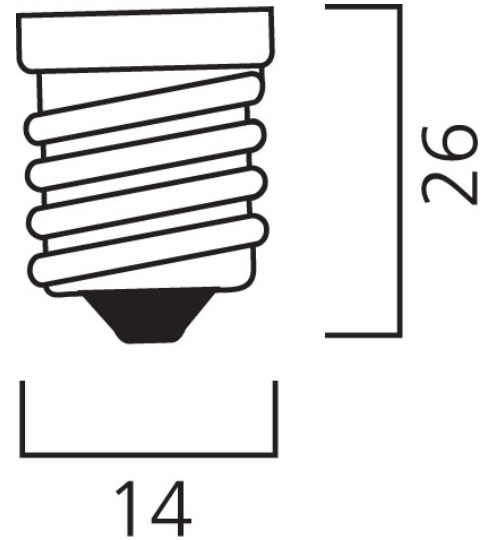
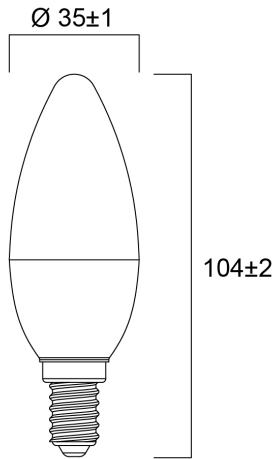

Data table

GENERAL DATA

Product name	ToLEDo Candle V7 470LM 827 E14 SL
Technology	LED
Watt (Rated) (W)	4.5
Cap/Base	E14
Fixture rating	Open
General application	Hospitality, Residential & Consumer
Operating temperature range (°C)	-20°C...+40°C
Performance ambient temperature Tq (°C)	25
ETIM Class	EC001959
E-number FI	4740997

ToLEDo Candle V7 470LM 827 E14 SL 0029607

Warranty	3 years
----------	---------

OPTICAL DATA

Useful luminous flux (#use)	470
Luminous flux (Rated) (lm)	470
Correlated colour temperature (k)	2700
Light colour	Homelight
CRI (Ra)	80
Colour Variation Initial (SDCM)	6
Photobiological Risk Group	RG0
Lumen maintenance at end of nominal life (%)	70

ELECTRICAL DATA

Power consumption (W)	4.5
Wattage (W)	4.5
Equivalent watt (W)	40
Primary Supply/Product voltage - min (V)	220
Primary Supply/Product voltage - max (V)	240
Control gear required	No
No. Of switching cycles before premature failures	>100000
Dimmable	No
Inrush Current (A)	2.4
Inrush Duration (μ s)	420
Lamp Energy Label (class)	F
Nominal Frequency (Hz)	50/60Hz
Max. products per 16A C Breaker	67
Max. products per 16A B Breaker	33

LIFETIME DATA

Lifespan L70 B50	15000
Average life (Nominal) (h)	15000
Average life (Rated) (h)	15000

PHYSICAL DATA

Nominal Product Length (mm)	104
Nominal Product Diameter (mm)	35
Weight (kg)	0.018

PACKAGING

Product EAN number	5410288296074
Packaging single length / height (cm)	4.5
Packaging single width (cm)	4.5
Packaging single depth (cm)	11.0
DUN14 (inner)	15410288296071
Units per outer package	6
Packaging outer length / height (cm)	14.3
Packaging outer width (cm)	9.7
Packaging outer depth (cm)	12.0

SAFETY DATA

Optimal operating condition (°C)	-20-40
Breakage cleaning instructions	Not applicable
Special purpose lamp	No
Dry applications use only	Yes
Suitable for household illumination	Yes
Safety message	Not Suitable for totally enclosed fixtures

SYLVANIA

ToLEDo Candle V7 470LM 827 E14 SL
0029607

Energy label



0029607



5
kWh/1000h



2019/2015



0029607



5
kWh/1000h



2019/2015