

## Data Sheet | Item Number: 2216-1201

2-conductor through terminal block; with push-button; 16 mm<sup>2</sup>; with test port; side and center marking; for DIN-rail 35 x 15 and 35 x 7.5; Push-in CAGE CLAMP®; 16,00 mm<sup>2</sup>; gray

<https://www.wago.com/2216-1201>

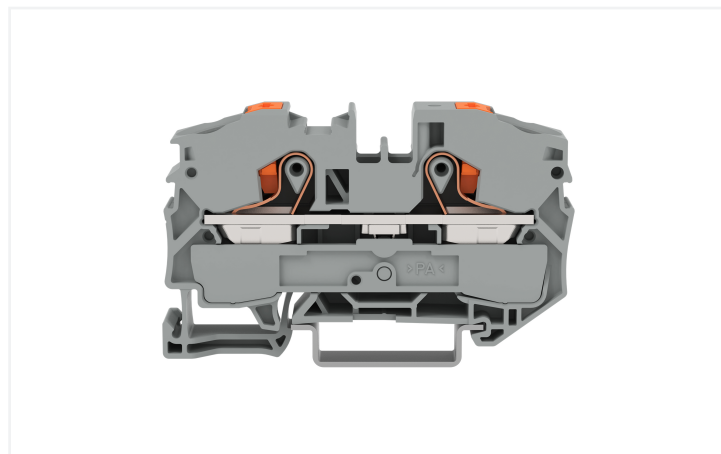
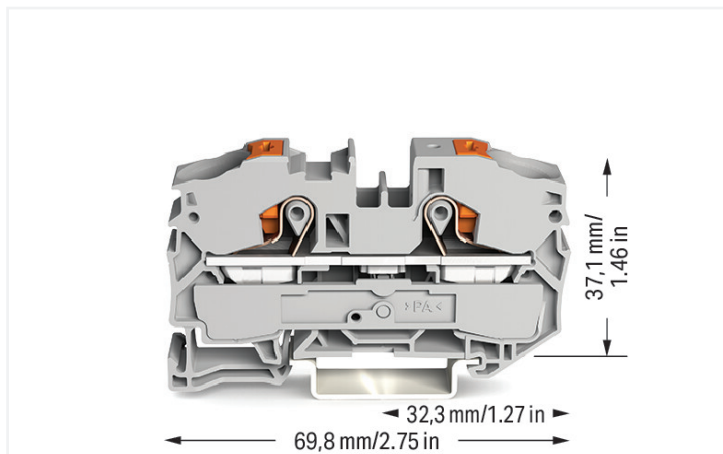

Color: ■ gray

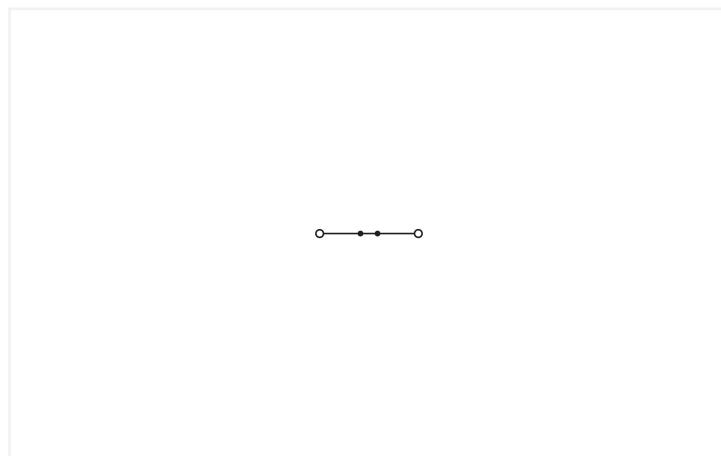

Similar to illustration

### Through terminal block, 2216 Series, Push-in CAGE CLAMP®

Easily, quickly and safely connect conductors with this through terminal block (item number 2216-1201). Strip lengths must be between 18 and 20 mm when connecting conductors to this through terminal block. Whether in industrial or building applications, our rail-mount through terminal blocks are the perfect solution to quickly and securely connect electrical conductors. Depending on the version, you can use them for either typical through-wiring or potential distribution. This product features conductor terminals and utilizes Push-in CAGE CLAMP®. Our Push-in CAGE CLAMP® is a universal, maintenance-free connection solution for all conductor types, featuring a winning design: It allows direct insertion of both solid and fine-stranded conductors with ferrules without needing tools. No preparation is required; for example, crimping the conductor's ferrule is not necessary. The dimensions are (12 x 69.8 x 43.7) mm (width x height x depth). Depending on the type of conductor, this through terminal block is ideal for conductor cross sections ranging from 0.5 mm<sup>2</sup> to 16 mm<sup>2</sup>.

This through rail-mount terminal block is operated with a push-button. Our TOPJOB® S rail-mount terminal blocks offer more than just secure electrical connections in various industrial applications and modern building installations. They also offer the perfect actuation option for every need: lever, push-button, or operating slot. This product is designed for specific Ex applications (please refer to the product datasheet).

## Electrical data

Ratings per	IEC/EN 60947-7-1		
Overvoltage category	III	III	II
Pollution degree	3	2	2
Nominal voltage	800 V	-	-
Rated impulse withstand voltage	8 kV	-	-
Rated current	76 A	-	-
Current at conductor cross-section (max.) mm <sup>2</sup>	90 A	-	-

## Ratings per IEC/EN – Notes

Rated current (note)	15 mm high DIN-35 rails shall be used for a current load higher than 76 A!
----------------------	--

Approvals per	UL 1059		
Use group	B	C	D
Rated voltage	600 V	600 V	-
Rated current	85 A	85 A	-

Approvals per	CSA 22.2 No 158		
Use group	B	C	D
Rated voltage	600 V	600 V	-
Rated current	85 A	85 A	-

## Ex information

Reference to hazardous areas	See "Downloads – Documentation – Additional Information: Technical Section; Technical Explanations"
Ratings per	ATEX: PTB 18 ATEX 1009 U / IECEx: PTB 18.0016U (Ex eb IIC Gb)
Rated voltage EN (Ex e II)	550 V
Rated current (Ex e II)	76 A
Rated current (Ex e II) with jumper	65 A

## Power Loss

Power loss, per pole (potential)	2.4259 W
Rated current $I_N$ for power loss specification	76 A
Resistance value for specified, current-dependent power loss	0.00042 $\Omega$

## General information

Wiring direction	Front-entry wiring
------------------	--------------------

## Connection Data

Clamping units	2
Total number of potentials	1
Number of levels	1
Number of jumper slots	2

## Connection 1

Connection technology	Push-in CAGE CLAMP®
Actuation type	Push-button
Connectable conductor materials	Copper
Nominal cross-section	16 mm <sup>2</sup>
Solid conductor	0.5 ... 16 mm <sup>2</sup> / 20 ... 6 AWG
Solid conductor; push-in termination	2.5 ... 16 mm <sup>2</sup> / 14 ... 6 AWG
Fine-stranded conductor	0.5 ... 25 mm <sup>2</sup> / 20 ... 4 AWG
Fine-stranded conductor; with insulated ferrule	0.5 ... 16 mm <sup>2</sup> / 20 ... 6 AWG
Fine-stranded conductor; with ferrule; push-in termination	6 ... 16 mm <sup>2</sup> / 10 ... 6 AWG
Note (conductor cross-section)	Depending on the conductor characteristic, a conductor with a smaller cross-section can also be inserted via push-in termination. AWG specifications were converted according to IEC.
Strip length	18 ... 20 mm / 0.71 ... 0.79 inches
Wiring direction	Front-entry wiring

### Physical data

Width	12 mm / 0.472 inches
Height	69.8 mm / 2.748 inches
Depth from upper-edge of DIN-rail	37.1 mm / 1.461 inches
Depth	43.7 mm / 1.72 inches

### Mechanical data

Mounting type	DIN-35 rail
Marking level	Center/side marking

### Material data

Note (material data)	<a href="#">Information on material specifications can be found here</a>
Color	gray
Material group	I
Insulation material (main housing)	Polyamide (PA66)
Flammability class per UL94	V0
Fire load	0.426 MJ
Actuator color	orange
Weight	23.7 g

### Environmental requirements

Processing temperature	-35 ... +85 °C
Continuous operating temperature	-60 ... +105 °C

### Environmental Testing

Test specification: Railway applications – Rolling stock – Electronic equipment	DIN EN 50155 (VDE 0115-200):2022-06
Test procedure: Railway applications – Rolling stock equipment – Vibration and shock tests	DIN EN 61373 (VDE 0115-0106):2011-04
Spectrum/Mounting location	Service life test, Category 1, Class A/B
Functional test with noise-like oscillations	Test passed according to Section 8 of the standard
Frequency	$f_1 = 5 \text{ Hz}$ to $f_2 = 150 \text{ Hz}$
Acceleration	0.101g (highest test level used for all axes)
Test duration per axis	10 min.
Test directions	X, Y and Z axes
Monitoring of contact faults and interruptions	Passed
Voltage drop measurement before and after each axis	Passed
Simulated service life test through increased levels of noise-like oscillations	Test passed according to Section 9 of the standard
Frequency	$f_1 = 5 \text{ Hz}$ to $f_2 = 150 \text{ Hz}$
Acceleration	0.572g (highest test level used for all axes)
Test duration per axis	5 h
Test directions	X, Y and Z axes
Extended testing: Monitoring of contact faults and interruptions	Passed
Extended testing: Voltage drop measurement before and after each axis	Passed
Shock test	Test passed according to Section 10 of the standard
Shock pulse form	Half sine
Acceleration	5g (highest test level used for all axes)
Shock duration	30 ms

**Environmental Testing**

Number of shocks (per axis)	3 pos. und 3 neg.
Test directions	X, Y and Z axes
Extended testing: Monitoring of contact faults and interruptions	Passed
Extended testing: Voltage drop measurement before and after each axis	Passed
Vibration and shock stress for rolling stock equipment	Passed

**Commercial data**

PU (SPU)	20 pcs
Packaging type	Box
Country of origin	DE
GTIN	4055143732727
Customs tariff number	85369010000

**Product Classification**

UNSPSC	39121410
eCl@ss 10.0	27-14-11-20
eCl@ss 9.0	27-14-11-20
ETIM 9.0	EC000897
ETIM 10.0	EC000897
ECCN	NO US CLASSIFICATION

**Environmental Product Compliance**

RoHS Compliance Status	Compliant, No Exemption
------------------------	-------------------------

**Approvals / Certificates**

**General approvals**



Approval	Standard	Certificate Name
CCA DEKRA Certification B.V.	EN 60947	NTR NL-7947
CSA DEKRA Certification B.V.	C22.2	70175032
cURus Underwriters Laboratories Inc.	C22.2 No. 158	E 45172
KEMA/KEUR DEKRA Certification B.V.	EN 60947	71-124545

**Declarations of conformity and manufacturer's declarations**



Approval	Standard	Certificate Name
ATEX-Attestation of Conformity WAGO GmbH & Co. KG	-	-
EU-Declaration of Conformity WAGO GmbH & Co. KG	-	-
Railway WAGO GmbH & Co. KG	-	Z00004408.000
UK-Declaration of Conformity WAGO GmbH & Co. KG	-	-

Approvals for marine applications



Approval	Standard	Certificate Name
ABS American Bureau of Ship- ping	-	24-0095985-PDA
BV Bureau Veritas S.A.	IEC 60947	58186/A0 BV
DNV GL Det Norske Veritas, Ger- manischer Lloyd	-	TAE00003JT
LR Lloyds Register	-	19/20050

Approvals for hazardous areas



Approval	Standard	Certificate Name
AEx Underwriters Laboratories Inc.	UL 60079	E185892 (AEx eb IIC resp. Ex eb IIC)
ATEX Physikalisch Technische Bundesanstalt	EN 60079-0	PTB 18 ATEX 1009 U (II 2 G Ex eb IIC Gb bzw. I M 2 Ex eb I Mb)
CCC CNEX	GB/T 3836.3	2020312313000175 (Ex eb IIC Gb, Ex eb I Mb)
IECEX Physikalisch Technische Bundesanstalt	IEC 60079	IECEX PTB 18.0016U (Ex eb IIC Gb and Ex eb I Mb)
INMETRO TÜV Rheinland do Brasil Ltda.	IEC 60079	TÜV 19.0822 U

Downloads

Environmental Product Compliance

Compliance Search	
Environmental Product Compliance 2216-1201	<a href="#">↓</a>

Documentation

Bid Text			
2216-1201	15.04.2019	xml 3.99 KB	<a href="#">↓</a>
2216-1201	15.04.2019	docx 15.05 KB	<a href="#">↓</a>

CAD/CAE-Data

CAD data	
2D/3D Models 2216-1201	<a href="#">↓</a>

CAE data	
EPLAN Data Portal 2216-1201	<a href="#">↓</a>
ZUKEN Portal 2216-1201	<a href="#">↓</a>

## 1 Compatible Products

### 1.1 Required Accessories

#### 1.1.1 End plate

##### 1.1.1.1 End plate



**Item No.: 2016-1291**

End and intermediate plate; 1 mm thick; gray



**Item No.: 2016-1292**

End and intermediate plate; 1 mm thick; orange



**Item No.: 209-191**

Separator for Ex e/Ex i applications; 3 mm thick; 120 mm wide; orange

### 1.2 Optional Accessories

#### 1.2.1 Cover

##### 1.2.1.1 Cover



**Item No.: 2016-100**

Finger guard; touchproof cover protects unused conductor entries; yellow

#### 1.2.2 DIN-rail

##### 1.2.2.1 Mounting accessories



**Item No.: 210-196**

Aluminum carrier rail; 35 x 8.2 mm; 1.6 mm thick; 2 m long; unslotted; similar to EN 60715; silver-colored



**Item No.: 210-198**

Copper carrier rail; 35 x 15 mm; 2.3 mm thick; 2 m long; unslotted; according to EN 60715; copper-colored



**Item No.: 210-197**

Steel carrier rail; 35 x 15 mm; 1.5 mm thick; 2 m long; slotted; similar to EN 60715; silver-colored



**Item No.: 210-114**

Steel carrier rail; 35 x 15 mm; 1.5 mm thick; 2 m long; unslotted; similar to EN 60715; silver-colored



**Item No.: 210-118**

Steel carrier rail; 35 x 15 mm; 2.3 mm thick; 2 m long; unslotted; according to EN 60715; silver-colored



**Item No.: 210-115**

Steel carrier rail; 35 x 7.5 mm; 1 mm thick; 2 m long; slotted; according to EN 60715; "Hole width 18 mm; silver-colored



**Item No.: 210-112**

Steel carrier rail; 35 x 7.5 mm; 1 mm thick; 2 m long; slotted; according to EN 60715; "Hole width 25 mm; silver-colored



**Item No.: 210-113**

Steel carrier rail; 35 x 7.5 mm; 1 mm thick; 2 m long; unslotted; according to EN 60715; silver-colored

#### 1.2.3 Ferrule

##### 1.2.3.1 Ferrule



**Item No.: 216-284**

Ferrule; Sleeve for 1.5 mm<sup>2</sup> / AWG 16; insulated; electro-tin plated; electrolytic copper; gastight crimped; acc. to DIN 46228, Part 4/09.90; black



**Item No.: 216-289**

Ferrule; Sleeve for 10 mm<sup>2</sup> / AWG 8; insulated; electro-tin plated; electrolytic copper; gastight crimped; acc. to DIN 46228, Part 4/09.90; red



**Item No.: 216-210**

Ferrule; Sleeve for 16 mm<sup>2</sup> / AWG 6; insulated; electro-tin plated; electrolytic copper; gastight crimped; acc. to DIN 46228, Part 4/09.90; blue



**Item No.: 216-286**

Ferrule; Sleeve for 2.5 mm<sup>2</sup> / AWG 14; insulated; electro-tin plated; electrolytic copper; gastight crimped; acc. to DIN 46228, Part 4/09.90; blue



**Item No.: 216-287**

Ferrule; Sleeve for 4 mm<sup>2</sup> / AWG 12; insulated; electro-tin plated; electrolytic copper; gastight crimped; acc. to DIN 46228, Part 4/09.90; gray



**Item No.: 216-288**

Ferrule; Sleeve for 6 mm<sup>2</sup> / AWG 10; insulated; electro-tin plated; electrolytic copper; gastight crimped; acc. to DIN 46228, Part 4/09.90; yellow

## 1.2.4 Installation

### 1.2.4.1 Cover



**Item No.: 709-156**

Cover; Type 3; suitable for cover carrier, type 3; 1 m long; transparent

### 1.2.4.2 Cover carrier



**Item No.: 709-169**

Cover carrier; Type 3; incl. fixing/retaining screws and knurled nut; suitable for 279 to 282 and 880 Series rail-mounted terminal blocks; suitable for 264 Series miniature rail-mounted terminal blocks; suitable for 270 Series sensor and actuator terminal blocks; gray

## 1.2.5 Jumper

### 1.2.5.1 Jumper



**Item No.: 2016-402**

Jumper; 2-way; insulated; light gray



**Item No.: 2016-403**

Jumper; 3-way; insulated; light gray



**Item No.: 2016-404**

Jumper; 4-way; insulated; light gray



**Item No.: 2016-405**

Jumper; 5-way; insulated; light gray



**Item No.: 2016-433**

Jumper; from 1 to 3; insulated; light gray



**Item No.: 2016-434**

Jumper; from 1 to 4; insulated; light gray



**Item No.: 2016-435**

Jumper; from 1 to 5; insulated; light gray



**Item No.: 2016-405/011-000**

Star point jumper; 3-way; insulated; light gray



**Item No.: 2016-499**

Step-down jumper; from 2016/2010 to 2010/2006/2004/2002 series; from 2216/2210 to 2210/2206/2204/2202 series; insulated; light gray



**Item No.: 285-430**

Step-down jumper; from 285 (35mm<sup>2</sup>) to 2016/2010 series; insulated; gray

## 1.2.6 Marking

### 1.2.6.1 Group marker carrier



**Item No.: 2009-191**

Group marker carrier; gray



**Item No.: 2009-192**











































Group marker carrier; gray



**Item No.: 2009-193**

Group marker carrier; gray

1.2.6.2 Marker

<p><b>Item No.: 2009-145/000-006</b> Mini-WSB Inline; for Smart Printer; 1700 pieces on roll; stretchable 5 - 5.2 mm; plain; snap-on type; blue</p> 	<p><b>Item No.: 2009-145/000-007</b> Mini-WSB Inline; for Smart Printer; 1700 pieces on roll; stretchable 5 - 5.2 mm; plain; snap-on type; gray</p> 	<p><b>Item No.: 2009-145/000-023</b> Mini-WSB Inline; for Smart Printer; 1700 pieces on roll; stretchable 5 - 5.2 mm; plain; snap-on type; green</p> 	<p><b>Item No.: 2009-145/000-012</b> Mini-WSB Inline; for Smart Printer; 1700 pieces on roll; stretchable 5 - 5.2 mm; plain; snap-on type; orange</p> 
<p><b>Item No.: 2009-145/000-005</b> Mini-WSB Inline; for Smart Printer; 1700 pieces on roll; stretchable 5 - 5.2 mm; plain; snap-on type; red</p> 	<p><b>Item No.: 2009-145/000-024</b> Mini-WSB Inline; for Smart Printer; 1700 pieces on roll; stretchable 5 - 5.2 mm; plain; snap-on type; violet</p> 	<p><b>Item No.: 2009-145</b> Mini-WSB Inline; for Smart Printer; 1700 pieces on roll; stretchable 5 - 5.2 mm; plain; snap-on type; white</p> 	<p><b>Item No.: 2009-145/000-002</b> Mini-WSB Inline; for Smart Printer; 1700 pieces on roll; stretchable 5 - 5.2 mm; plain; snap-on type; yellow</p> 
<p><b>Item No.: 248-501/000-006</b> Mini-WSB marking card; as card; not stretchable; plain; snap-on type; blue</p> 	<p><b>Item No.: 248-501/000-007</b> Mini-WSB marking card; as card; not stretchable; plain; snap-on type; gray</p> 	<p><b>Item No.: 248-501/000-023</b> Mini-WSB marking card; as card; not stretchable; plain; snap-on type; green</p> 	<p><b>Item No.: 248-501/000-017</b> Mini-WSB marking card; as card; not stretchable; plain; snap-on type; light green</p> 
<p><b>Item No.: 248-501/000-012</b> Mini-WSB marking card; as card; not stretchable; plain; snap-on type; orange</p> 	<p><b>Item No.: 248-501/000-005</b> Mini-WSB marking card; as card; not stretchable; plain; snap-on type; red</p> 	<p><b>Item No.: 248-501/000-024</b> Mini-WSB marking card; as card; not stretchable; plain; snap-on type; violet</p> 	<p><b>Item No.: 248-501</b> Mini-WSB marking card; as card; not stretchable; plain; snap-on type; white</p> 
<p><b>Item No.: 248-501/000-002</b> Mini-WSB marking card; as card; not stretchable; plain; snap-on type; yellow</p> 	<p><b>Item No.: 793-5501/000-006</b> WMB marking card; as card; for terminal block width 5 - 17.5 mm; stretchable 5 - 5.2 mm; plain; snap-on type; blue</p> 	<p><b>Item No.: 793-5501/000-007</b> WMB marking card; as card; for terminal block width 5 - 17.5 mm; stretchable 5 - 5.2 mm; plain; snap-on type; gray</p> 	<p><b>Item No.: 793-5501/000-023</b> WMB marking card; as card; for terminal block width 5 - 17.5 mm; stretchable 5 - 5.2 mm; plain; snap-on type; green</p> 
<p><b>Item No.: 793-5501/000-017</b> WMB marking card; as card; for terminal block width 5 - 17.5 mm; stretchable 5 - 5.2 mm; plain; snap-on type; light green</p> 	<p><b>Item No.: 793-5501/000-012</b> WMB marking card; as card; for terminal block width 5 - 17.5 mm; stretchable 5 - 5.2 mm; plain; snap-on type; orange</p> 	<p><b>Item No.: 793-5501/000-005</b> WMB marking card; as card; for terminal block width 5 - 17.5 mm; stretchable 5 - 5.2 mm; plain; snap-on type; red</p> 	<p><b>Item No.: 793-5501/000-024</b> WMB marking card; as card; for terminal block width 5 - 17.5 mm; stretchable 5 - 5.2 mm; plain; snap-on type; violet</p> 
<p><b>Item No.: 793-5501</b> WMB marking card; as card; for terminal block width 5 - 17.5 mm; stretchable 5 - 5.2 mm; plain; snap-on type; white</p> 	<p><b>Item No.: 793-5501/000-002</b> WMB marking card; as card; for terminal block width 5 - 17.5 mm; stretchable 5 - 5.2 mm; plain; snap-on type; yellow</p> 	<p><b>Item No.: 793-501/000-006</b> WMB marking card; as card; not stretchable; plain; snap-on type; blue</p> 	<p><b>Item No.: 793-501/000-007</b> WMB marking card; as card; not stretchable; plain; snap-on type; gray</p> 
<p><b>Item No.: 793-501/000-023</b> WMB marking card; as card; not stretchable; plain; snap-on type; green</p> 	<p><b>Item No.: 793-501/000-017</b> WMB marking card; as card; not stretchable; plain; snap-on type; light green</p> 	<p><b>Item No.: 793-501/000-012</b> WMB marking card; as card; not stretchable; plain; snap-on type; orange</p> 	<p><b>Item No.: 793-501/000-005</b> WMB marking card; as card; not stretchable; plain; snap-on type; red</p> 
<p><b>Item No.: 793-501/000-024</b> WMB marking card; as card; not stretchable; plain; snap-on type; violet</p> 	<p><b>Item No.: 793-501</b> WMB marking card; as card; not stretchable; plain; snap-on type; white</p> 	<p><b>Item No.: 793-501/000-002</b> WMB marking card; as card; not stretchable; plain; snap-on type; yellow</p> 	<p><b>Item No.: 2009-115/000-006</b> WMB-Inline; for Smart Printer; 1500 pieces on roll; stretchable 5 - 5.2 mm; plain; snap-on type; blue</p> 
<p><b>Item No.: 2009-115/000-007</b> WMB-Inline; for Smart Printer; 1500 pieces on roll; stretchable 5 - 5.2 mm; plain; snap-on type; gray</p> 	<p><b>Item No.: 2009-115/000-023</b> WMB-Inline; for Smart Printer; 1500 pieces on roll; stretchable 5 - 5.2 mm; plain; snap-on type; green</p> 	<p><b>Item No.: 2009-115/000-017</b> WMB-Inline; for Smart Printer; 1500 pieces on roll; stretchable 5 - 5.2 mm; plain; snap-on type; light green</p> 	<p><b>Item No.: 2009-115/000-012</b> WMB-Inline; for Smart Printer; 1500 pieces on roll; stretchable 5 - 5.2 mm; plain; snap-on type; orange</p> 
<p><b>Item No.: 2009-115/000-024</b> WMB-Inline; for Smart Printer; 1500 pieces on roll; stretchable 5 - 5.2 mm; plain; snap-on type; violet</p> 	<p><b>Item No.: 2009-115</b> WMB-Inline; for Smart Printer; 1500 pieces on roll; stretchable 5 - 5.2 mm; plain; snap-on type; white</p> 	<p><b>Item No.: 2009-115/000-002</b> WMB-Inline; for Smart Printer; 1500 pieces on roll; stretchable 5 - 5.2 mm; plain; snap-on type; yellow</p> 	

### 1.2.6.3 Marker carrier



**Item No.: 2009-198**

Adaptor; gray

### 1.2.6.4 Marking strip



**Item No.: 2009-110**

Marking strips; for Smart Printer; on reel; not stretchable; plain; snap-on type; white

## 1.2.7 Screwless end stop

### 1.2.7.1 Mounting accessories



**Item No.: 249-117**

Screwless end stop; 10 mm wide; for DIN-rail 35 x 15 and 35 x 7.5; gray



**Item No.: 249-116**

Screwless end stop; 6 mm wide; for DIN-rail 35 x 15 and 35 x 7.5; gray

## 1.2.8 Test and measurement

### 1.2.8.1 Testing accessories



**Item No.: 2016-511**

Modular TOPJOB®S connector; modular; for jumper contact slot; 1-pole; gray



**Item No.: 2016-549**

Spacer module; modular; e.g., for bridging commoned terminal blocks; gray



**Item No.: 2009-174**

Test plug adapter; for 4 mm Ø test plugs; for testing TOPJOB®S rail-mounted terminal blocks; gray



**Item No.: 2009-182**

Testing tap; for max. 2.5 mm<sup>2</sup>; tool-free connection for individual test wires 0.08 - 2.5 mm; gray

## 1.2.9 Tool

### 1.2.9.1 Operating tool



**Item No.: 210-721**

Operating tool; Blade: 5.5 x 0.8 mm; with a partially insulated shaft; multicoloured

## Installation Notes

### Conductor termination



All conductor types at a glance



Push-in termination of solid and ferruled conductors



Push-in termination of solid and ferruled conductors



Insert fine-stranded conductors via operating tool.

## Conductor termination



Removing all conductors via operating tool.

## Commoning

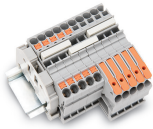

Insert a push-in type jumper bar and push down until it hits the backstop.



Commoning with step-down jumpers.

## Testing



Testing with a 2 mm Ø test plug (max. 42 V).

## Marking

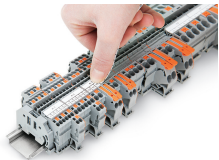

Snapping a marking strip into a marker slot.

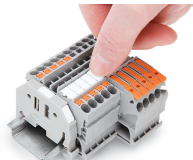

Snapping a marking strip into the marker slot.