

40P-2622S: Press Elbow to copper compression 26x22

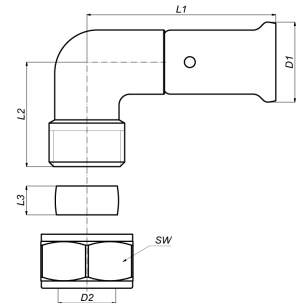

Commercial information

The body of the fitting is made from CW617N brass. These fittings offer great advantages with regard to corrosion and they are also also better for the environment.

- The fitting has a buffer ring that prevents direct galvanic contact between the aluminium of the pipe and the brass of the fitting.
- This excludes the possibility of electrolysis occurring.
- The fitting is equipped with O-rings made from EPDM and RVS pressure sleeves with 3 inspection windows.
- In order to prevent assembly errors, the dimensions and type of press profile which can be pressed are shown on the RVS sleeves

Basic unit dimensions

Height	62 mm
Length	75 mm
Width	36 mm
Net weight	0.230 kg

Certificates

ATG, DVGW Wasser, ETA, KIWA, ÖVGW Wasser, WRAS, KOMO, STF, ÖN EN 21003-2/-3, GOST-R, ITC, TSU, QB (CSTBat), AFNOR, ACS, PZH, DNV-GL, EMI

Applications

Potable water, Heating, Compressed air, Cooling, Sanitary

Solutions

Building installations, Industry, Utility, Shipbuilding

Technical characteristics

Material connection 1	Brass	Bend radius	26 Millimetre
Material quality connection 1	CuZn40Pb2 (CW617N)	Outer pipe diameter connection 1	26 Millimetre
Surface protection connection 1	Untreated	Outer pipe diameter connection 2	22 Millimetre
Surface treatment connection 1	Untreated	Length	75 Millimetre
Material connection 2	Brass	Length of connection 1	56 Millimetre
Material quality connection 2	CuZn40Pb2 (CW617N)	Working length connection 1	56 Millimetre
Surface protection connection 2	Untreated	Length of connection 2	42 Millimetre
Surface treatment connection 2	Untreated	Working length connection 2	42 Millimetre
Shape	Bend	Wrench width	0 Millimetre
Reducing	✘	Wrench width union nut	0 Millimetre
Eccentric	✘	Medium temperature (continuous)	-10 70 Degrees celsius
System specific	✓	Max. operating pressure at 20 °C	16 Bar
Connection 1	Press sleeve	Standard Dimension Ratio (SDR)	0
Contour code connection 1	TH		
Connection 2	Clamp connection		
Main colour fitting	Brass		
Material sealing	Ethylene-propylene diene monomer rubber (EPDM)		
With buffer stud	✓		
High tensile strength	✘		
With thermal insulation	✘		
Ring stiffness class	Other		
With sealing rings/gaskets	✓		
Capped	✘		
With drain valve	✘		
With de-aerator	✘		
FM quality mark	✘		
LPCB quality mark	✘		
ULC quality mark	✘		
UL quality mark	✘		
DIN-CERTCO certificate	✘		
VdS quality mark	✘		
With approval for TÜV	✘		
DVGW quality mark for gas	✘		
DVGW quality mark for water	✓		
KIWA certified	✓		
Gastec QA mark	✘		
KOMO certified	✓		
Type approval according to BBR/EKS	✘		