

Data Sheet | Item Number: 280-565

2-conductor actuator terminal block; with colored conductor entries; 2.5 mm²; CA-GE CLAMP®; 2,50 mm²; gray

<https://www.wago.com/280-565>

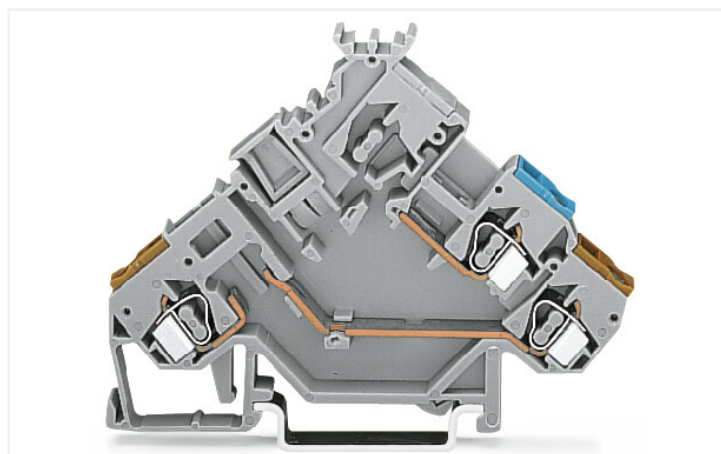
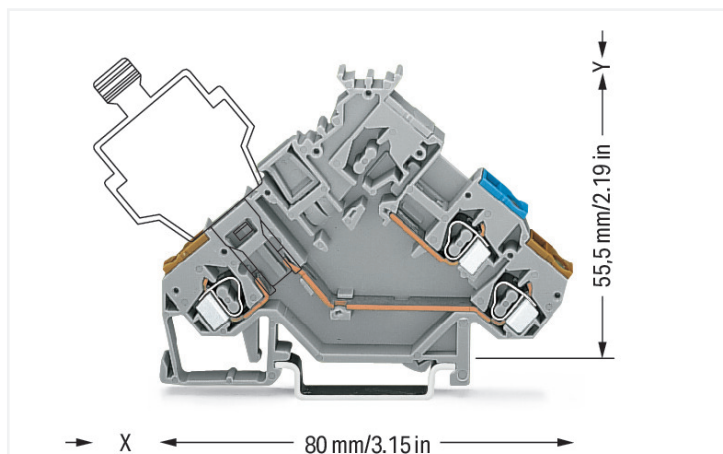

Color: ■ gray

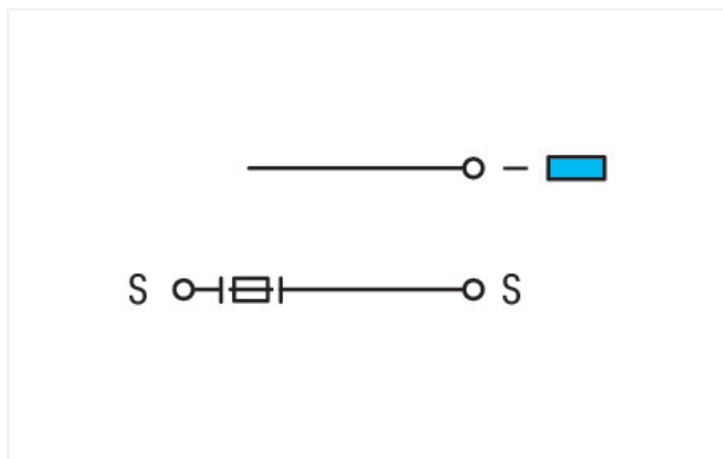

280-565

Electrical data

Ratings per IEC/EN

Ratings (note)	Electrical ratings are given by the fuse plug or empty component plug housing.
Nominal voltage (III/3)	125 V
Rated current	5 A
Legend (ratings)	(III / 3) Δ Overvoltage category III / Pollution degree 3

Ratings per IEC/EN 2

Rated voltage (III/3) 2	250 V
Rated current 2	6.3 A

Power Loss

Power loss, per pole (potential)	0.0333 W
Rated current I _N for specified power loss	5 A
Resistance value for specified, current-dependent power loss	0.00133 Ω

Connection data

Connection points	3
Total number of potentials	3
Number of levels	3

Connection 1

Connection technology	CAGE CLAMP®
Actuation type	Operating tool
Connectable conductor materials	Copper Aluminum

Connectable conductor materials (note) **Terminating Aluminum Conductors**
WAGO spring clamp terminal blocks are suitable for solid aluminum conductors up to 4 mm²/12 AWG if WAGO "Alu-Plus" Contact Paste [249-130](https://www.wago.com/249-130) is used for termination.

"Alu-Plus" Contact Paste Advantages:

- Automatically destroys the oxide film during clamping.
- Prevents fresh oxidation at the clamping point.
- Prevents electrolytic corrosion between aluminum and copper conductors (in the same terminal block).
- Provides long-term protection against corrosion.

Using terminal blocks with CAGE CLAMP® Spring Pressure Connection Technology, **aluminum conductors must first be cleaned with a blade** and then immediately be inserted into the clamping units filled with "Alu-Plus" Contact Paste.

It is also possible to apply WAGO "Alu-Plus" **additionally** on the whole surface of the aluminum conductor before termination.

Please note that the nominal currents must be adapted to the reduced conductivity of the aluminum conductors::

2.5 mm² = 16 A

4 mm² = 22 A

Solid conductor	0.08 ... 2.5 mm ² / 28 ... 12 AWG
Fine-stranded conductor	0.08 ... 2.5 mm ² / 28 ... 12 AWG
Note (conductor cross-section)	12 AWG: THHN, THWN
Strip length	8 ... 9 mm / 0.31 ... 0.35 inches
Wiring direction	Front-entry wiring

Physical data

Width	5 mm / 0.197 inches
Height	80 mm / 3.15 inches
Depth from upper-edge of DIN-rail	55.5 mm / 2.185 inches

Mechanical data

Design	angled
Mounting type	DIN-35 rail
Marking level	Center marking

Material data

Note (material data)	Information on material specifications can be found here
Color	gray
Material group	I
Insulation material	Polyamide (PA66)
Flammability class per UL94	V0
Fire load	0.297 MJ
Weight	9.8 g

Environmental requirements

Processing temperature	-35 ... +85 °C
Continuous operating temperature	-60 ... +105 °C

Commercial data

Product Group	1 (Rail Mounted Terminal Blocks)
eCl@ss 10.0	27-14-11-28
eCl@ss 9.0	27-14-11-28
ETIM 8.0	EC000900
ETIM 7.0	EC000900
PU (SPU)	50 pcs
Packaging type	Box
Country of origin	DE
GTIN	4044918890212
Customs tariff number	85369010000

Environmental Product Compliance

RoHS Compliance Status	Compliant, No Exemption
------------------------	-------------------------

Approvals / Certificates

General approvals



Approval	Standard	Certificate Name
CSA DEKRA Certification B.V.	C22.2	1536071
UR Underwriters Laboratories Inc.	UL 1059	E45172

Downloads

Environmental Product Compliance

Compliance Search

Environmental Product Compliance 280-565



Documentation

Additional Information

Technical Section

pdf
2240.62 KB



Bid Text

280-565

19.02.2019

xml
3.47 KB



280-565

30.03.2017

doc
25.00 KB



CAD/CAE-Data

CAE data

EPLAN Data Portal
280-565



WSCAD Universe
280-565



1 Compatible Products

1.1 Required Accessories

1.1.1 End plate

1.1.1.1 End plate



Item No.: 280-319

End and intermediate plate; 1 mm thick; for triple-deck terminal blocks; gray

Item No.: 280-321

End and intermediate plate; 1 mm thick; for triple-deck terminal blocks; orange

1.2 Optional Accessories

1.2.1 DIN-rail

1.2.1.1 Mounting accessories



Item No.: 210-196

Aluminum carrier rail; 35 x 8.2 mm; 1.6 mm thick; 2 m long; unslotted; similar to EN 60715; silver-colored



Item No.: 210-198

Copper carrier rail; 35 x 15 mm; 2.3 mm thick; 2 m long; unslotted; according to EN 60715; copper-colored



Item No.: 210-508

Steel carrier rail; 35 x 15 mm; 1.5 mm thick; 2 m long; slotted; galvanized; similar to EN 60715; silver-colored



Item No.: 210-197

Steel carrier rail; 35 x 15 mm; 1.5 mm thick; 2 m long; slotted; similar to EN 60715; silver-colored



Item No.: 210-506

Steel carrier rail; 35 x 15 mm; 1.5 mm thick; 2 m long; unslotted; galvanized; similar to EN 60715; silver-colored



Item No.: 210-114

Steel carrier rail; 35 x 15 mm; 1.5 mm thick; 2 m long; unslotted; similar to EN 60715; silver-colored



Item No.: 210-118

Steel carrier rail; 35 x 15 mm; 2.3 mm thick; 2 m long; unslotted; according to EN 60715; silver-colored



Item No.: 210-115

Steel carrier rail; 35 x 7.5 mm; 1 mm thick; 2 m long; slotted; according to EN 60715; "Hole width 18 mm; silver-colored

1.2.1.1 Mounting accessories



Item No.: 210-112

Steel carrier rail; 35 x 7.5 mm; 1 mm thick; 2 m long; slotted; according to EN 60715; "Hole width 25 mm; silver-colored



Item No.: 210-504

Steel carrier rail; 35 x 7.5 mm; 1 mm thick; 2 m long; slotted; galvanized; according to EN 60715; silver-colored



Item No.: 210-113

Steel carrier rail; 35 x 7.5 mm; 1 mm thick; 2 m long; unslotted; according to EN 60715; silver-colored



Item No.: 210-505

Steel carrier rail; 35 x 7.5 mm; 1 mm thick; 2 m long; unslotted; galvanized; according to EN 60715; silver-colored

1.2.2 Ferrule

1.2.2.1 Ferrule



Item No.: 216-301

Ferrule; Sleeve for 0.25 mm² / AWG 24; insulated; electro-tin plated; yellow



Item No.: 216-302

Ferrule; Sleeve for 0.34 mm² / 22 AWG; insulated; electro-tin plated; light turquoise



Item No.: 216-201

Ferrule; Sleeve for 0.5 mm² / 20 AWG; insulated; electro-tin plated; white



Item No.: 216-101

Ferrule; Sleeve for 0.5 mm² / AWG 22; un-insulated; electro-tin plated; silver-colored



Item No.: 216-202

Ferrule; Sleeve for 0.75 mm² / 18 AWG; insulated; electro-tin plated; gray



Item No.: 216-102

Ferrule; Sleeve for 0.75 mm² / AWG 20; un-insulated; electro-tin plated; silver-colored



Item No.: 216-203

Ferrule; Sleeve for 1 mm² / AWG 18; insulated; electro-tin plated; red



Item No.: 216-103

Ferrule; Sleeve for 1 mm² / AWG 18; un-insulated; electro-tin plated



Item No.: 216-204

Ferrule; Sleeve for 1.5 mm² / AWG 16; insulated; electro-tin plated; black



Item No.: 216-104

Ferrule; Sleeve for 1.5 mm² / AWG 16; un-insulated; electro-tin plated; silver-colored

1.2.3 Installation

1.2.3.1 Cover



Item No.: 709-154

Cover; Type 2; suitable for cover carrier, type 2; 1 m long; transparent

1.2.3.2 Cover carrier



Item No.: 709-168

Cover carrier; Type 2; incl. fixing/retaining screws and knurled nut; suitable for 283 to 285 Series rail-mounted terminal blocks; suitable for 279 to 281 Series double- and triple-deck terminal blocks; suitable for 780 to 785, 775, 776 and 777 Series TOP-JOB® rail-mounted terminal blocks; suitable for 280 Series sensor and actuator terminal blocks; suitable for 282 Series disconnect/test terminal blocks for transformer circuits; gray

1.2.3.3 Mounting accessories



Item No.: 249-116

Screwless end stop; 6 mm wide; for DIN-rail 35 x 15 and 35 x 7.5; gray

1.2.4 Insulation stop

1.2.4.1 Insulation stop



Item No.: 280-470

Insulation stop; 0.08 - 0.2 mm² "s" (0.14 mm² "f-st"); 5 pieces/strip; white



Item No.: 280-471

Insulation stop; 0.25 - 0.5 mm²; 5 pieces/strip; light gray



Item No.: 280-472

Insulation stop; 0.75 - 1 mm²; 5 pieces/strip; black

1.2.5 Jumper

1.2.5.1 Jumper



Item No.: 280-490

Jumper; 10-way; insulated; gray



Item No.: 280-482

Jumper; 2-way; insulated; gray



Item No.: 280-492

Jumper; 2-way; insulated; gray



Item No.: 280-483

Jumper; 3-way; insulated; gray



Item No.: 280-484

Jumper; 4-way; insulated; gray



Item No.: 280-485

Jumper; 5-way; insulated; gray



Item No.: 280-402

Jumper; insulated; gray



Item No.: 780-452

Staggered jumper; from 1 to 2; insulated; gray



Item No.: 780-453

Staggered jumper; from 1 to 3; insulated; gray



Item No.: 780-454

Staggered jumper; from 1 to 4; insulated; gray



Item No.: 780-455

Staggered jumper; from 1 to 5; insulated; gray



Item No.: 780-456

Staggered jumper; from 1 to 6; insulated; gray



Item No.: 780-457

Staggered jumper; from 1 to 7; insulated; gray



Item No.: 780-458

Staggered jumper; from 1 to 8; insulated; gray



Item No.: 709-110

Wire commoning chain; 2.5 mm²; insulated; black



Item No.: 709-111

Wire commoning chain; 2.5 mm²; insulated; black



Item No.: 709-112

Wire commoning chain; 2.5 mm²; insulated; black



Item No.: 210-103

Wire commoning chain; insulated; black

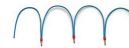

Item No.: 210-123

Wire commoning chain; insulated; blue

1.2.6 Marking

1.2.6.1 Marker



Item No.: 793-5501/000-006

WMB marking card; as card; for terminal block width 5 - 17.5 mm; stretchable 5 - 5.2 mm; plain; snap-on type; blue



Item No.: 793-5501/000-007

WMB marking card; as card; for terminal block width 5 - 17.5 mm; stretchable 5 - 5.2 mm; plain; snap-on type; gray



Item No.: 793-5501/000-023

WMB marking card; as card; for terminal block width 5 - 17.5 mm; stretchable 5 - 5.2 mm; plain; snap-on type; green



Item No.: 793-5501/000-017

WMB marking card; as card; for terminal block width 5 - 17.5 mm; stretchable 5 - 5.2 mm; plain; snap-on type; light green



Item No.: 793-5501/000-012

WMB marking card; as card; for terminal block width 5 - 17.5 mm; stretchable 5 - 5.2 mm; plain; snap-on type; orange



Item No.: 793-5501/000-005

WMB marking card; as card; for terminal block width 5 - 17.5 mm; stretchable 5 - 5.2 mm; plain; snap-on type; red



Item No.: 793-5501/000-024

WMB marking card; as card; for terminal block width 5 - 17.5 mm; stretchable 5 - 5.2 mm; plain; snap-on type; violet



Item No.: 793-5501

WMB marking card; as card; for terminal block width 5 - 17.5 mm; stretchable 5 - 5.2 mm; plain; snap-on type; white

1.2.6.1 Marker



Item No.: 793-5501/000-002
WMB marking card; as card; for terminal block width 5 - 17.5 mm; stretchable 5 - 5.2 mm; plain; snap-on type; yellow

Item No.: 793-501/000-006
WMB marking card; as card; not stretchable; plain; snap-on type; blue

Item No.: 793-501/000-007
WMB marking card; as card; not stretchable; plain; snap-on type; gray

Item No.: 793-501/000-023
WMB marking card; as card; not stretchable; plain; snap-on type; green



Item No.: 793-501/000-017
WMB marking card; as card; not stretchable; plain; snap-on type; light green

Item No.: 793-501/000-012
WMB marking card; as card; not stretchable; plain; snap-on type; orange

Item No.: 793-501/000-005
WMB marking card; as card; not stretchable; plain; snap-on type; red

Item No.: 793-501/000-024
WMB marking card; as card; not stretchable; plain; snap-on type; violet



Item No.: 793-501
WMB marking card; as card; not stretchable; plain; snap-on type; white

Item No.: 793-501/000-002
WMB marking card; as card; not stretchable; plain; snap-on type; yellow

Item No.: 2009-115/000-006
WMB-Inline; for Smart Printer; 1500 pieces on roll; stretchable 5 - 5.2 mm; plain; snap-on type; blue

Item No.: 2009-115/000-007
WMB-Inline; for Smart Printer; 1500 pieces on roll; stretchable 5 - 5.2 mm; plain; snap-on type; gray



Item No.: 2009-115/000-023
WMB-Inline; for Smart Printer; 1500 pieces on roll; stretchable 5 - 5.2 mm; plain; snap-on type; green

Item No.: 2009-115/000-017
WMB-Inline; for Smart Printer; 1500 pieces on roll; stretchable 5 - 5.2 mm; plain; snap-on type; light green

Item No.: 2009-115/000-012
WMB-Inline; for Smart Printer; 1500 pieces on roll; stretchable 5 - 5.2 mm; plain; snap-on type; orange

Item No.: 2009-115/000-024
WMB-Inline; for Smart Printer; 1500 pieces on roll; stretchable 5 - 5.2 mm; plain; snap-on type; violet



Item No.: 2009-115
WMB-Inline; for Smart Printer; 1500 pieces on roll; stretchable 5 - 5.2 mm; plain; snap-on type; white

Item No.: 2009-115/000-002
WMB-Inline; for Smart Printer; 1500 pieces on roll; stretchable 5 - 5.2 mm; plain; snap-on type; yellow

1.2.7 Plug

1.2.7.1 Empty component plug housing



Item No.: 280-801
Empty component plug housing; gray

1.2.7.2 Fuse plug



Item No.: 281-512/281-418
Fuse plug; with pull-tab; for miniature metric fuses 5 x 20 mm and 5 x 25 mm; with blown fuse indication by neon lamp; 120 V; 6 mm wide; gray



Item No.: 281-512/281-417
Fuse plug; with pull-tab; for miniature metric fuses 5 x 20 mm and 5 x 25 mm; with blown fuse indication by neon lamp; 230 V; 6 mm wide; gray



Item No.: 281-512/281-501
Fuse plug; with pull-tab; for miniature metric fuses 5 x 20 mm and 5 x 25 mm; with LED indicator; 24 V AC/DC; 6 mm wide; gray



Item No.: 281-512
Fuse plug; with pull-tab; for miniature metric fuses 5 x 20 mm and 5 x 25 mm; with port for LED; 6 mm wide; gray



Item No.: 281-511
Fuse plug; with pull-tab; for miniature metric fuses 5 x 20 mm and 5 x 25 mm; without blown fuse indication; 6 mm wide; gray



Item No.: 280-854
Fuse plug; with soldered miniature fuse; 1 A FF; 5 mm wide; gray



Item No.: 280-856
Fuse plug; with soldered miniature fuse; 2 A FF; 5 mm wide; gray



Item No.: 280-850
Fuse plug; with soldered miniature fuse; 250 mA FF; 5 mm wide; gray



Item No.: 280-852
Fuse plug; with soldered miniature fuse; 500 mA FF; 5 mm wide; gray



Item No.: 280-854/281-415
Fuse plug; with soldered miniature fuse; with indicator lamp; LED (red); AC 15 - 30 V; 1 A FF; 5 mm wide; gray



Item No.: 280-856/281-415
Fuse plug; with soldered miniature fuse; with indicator lamp; LED (red); AC 15 - 30 V; 2 A FF; 5 mm wide; gray



Item No.: 280-850/281-415
Fuse plug; with soldered miniature fuse; with indicator lamp; LED (red); AC 15 - 30 V; 250 mA FF; 5 mm wide; gray



Item No.: 280-852/281-415
Fuse plug; with soldered miniature fuse; with indicator lamp; LED (red); AC 15 - 30 V; 500 mA FF; 5 mm wide; gray



Item No.: 280-854/281-413
Fuse plug; with soldered miniature fuse; with indicator lamp; LED (red); DC 15 - 30 V; 1 A FF; 5 mm wide; gray



Item No.: 280-856/281-413
Fuse plug; with soldered miniature fuse; with indicator lamp; LED (red); DC 15 - 30 V; 2 A FF; 5 mm wide; gray



Item No.: 280-850/281-413
Fuse plug; with soldered miniature fuse; with indicator lamp; LED (red); DC 15 - 30 V; 250 mA FF; 5 mm wide; gray

1.2.7.2 Fuse plug



Item No.: 280-852/281-413
 Fuse plug; with soldered miniature fuse; with indicator lamp; LED (red); DC 15 - 30 V; 500 mA FF; 5 mm wide; gray

Item No.: 280-854/281-414
 Fuse plug; with soldered miniature fuse; with indicator lamp; LED (red); DC 30 - 65 V; 1 A FF; 5 mm wide; gray

Item No.: 280-856/281-414
 Fuse plug; with soldered miniature fuse; with indicator lamp; LED (red); DC 30 - 65 V; 2 A FF; 5 mm wide; gray

Item No.: 280-850/281-414
 Fuse plug; with soldered miniature fuse; with indicator lamp; LED (red); DC 30 - 65 V; 250 mA FF; 5 mm wide; gray



Item No.: 280-852/281-414
 Fuse plug; with soldered miniature fuse; with indicator lamp; LED (red); DC 30 - 65 V; 500 mA FF; 5 mm wide; gray

1.2.8 Protective warning marker

1.2.8.1 Cover



Item No.: 280-415
 Protective warning marker; for 5 terminal blocks; with high-voltage symbol, black; yellow

1.2.9 Push-in type wire jumper

1.2.9.1 Jumper



Item No.: 249-126
 Push-in type wire jumper; 0.75 mm²; insulated; 110 mm long; black

Item No.: 249-123
 Push-in type wire jumper; 0.75 mm²; insulated; 180 mm long; black

Item No.: 249-127
 Push-in type wire jumper; 0.75 mm²; insulated; 250 mm long; black

Item No.: 249-125
 Push-in type wire jumper; insulated; 60 mm long; black

1.2.10 Test and measurement

1.2.10.1 Testing accessories



Item No.: 209-170
 Test plug adapter; 8.3 mm wide; for 4 mm Ø test plugs; suitable for 1.5 mm² - 10 mm² tbs; gray

1.2.11 Tool

1.2.11.1 Operating tool



Item No.: 210-658
 Operating tool; Blade: 3.5 x 0.5 mm; with a partially insulated shaft; angled; short; multicoloured

Item No.: 210-720
 Operating tool; Blade: 3.5 x 0.5 mm; with a partially insulated shaft; multicoloured

Item No.: 210-657
 Operating tool; Blade: 3.5 x 0.5 mm; with a partially insulated shaft; short; multicoloured

Installation Notes

Installation

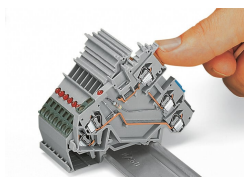

Snapping a terminal block onto the DIN-rail. Terminal blocks with a grounding foot automatically establish a direct contact to the rail.

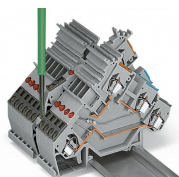

Removing the terminal block from DIN-rail. Notice: Remove jumper contacts first!

Conductor termination

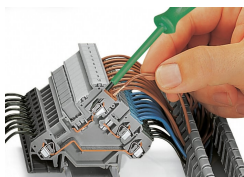

CAGE CLAMP® connection
Inserting a conductor via straight operating tool (210-720).

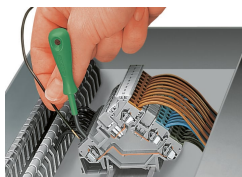

CAGE CLAMP® connection
Inserting a conductor via angled operating tool (210-658).

Commoning

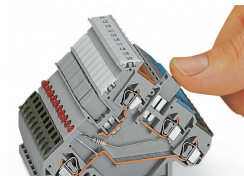

Commoning using an adjacent jumper (280-402). Push jumper down until fully inserted.

Testing

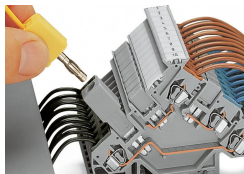

Testing via banana plug and test plug adapter (209-170).

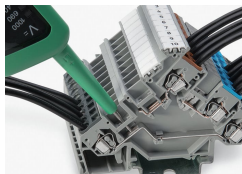

Testing via voltage tester directly on the current bar.

Application



Actuator terminal blocks with fuse holders (281-511) Intermediate plates are required!

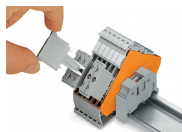

Actuator terminal blocks with component plugs (280-801)

Installation

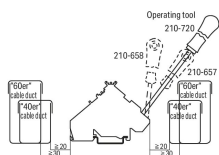

Min. mounting distance – terminal blocks to cable duct

Marking

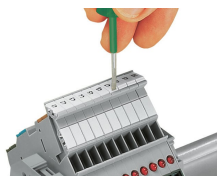

Labeling via WMB Multi Marking System.