

# Data Sheet | Item Number: 236-403/332-000

PCB terminal block; 2.5 mm<sup>2</sup>; Pin spacing 5/5.08 mm; 3-pole; CAGE CLAMP®; commoning option; gray

<https://www.wago.com/236-403/332-000>

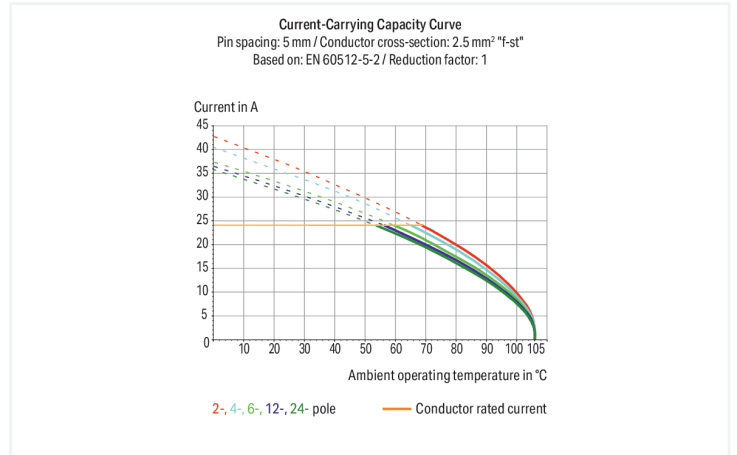

Color: ■ gray

Similar to illustration

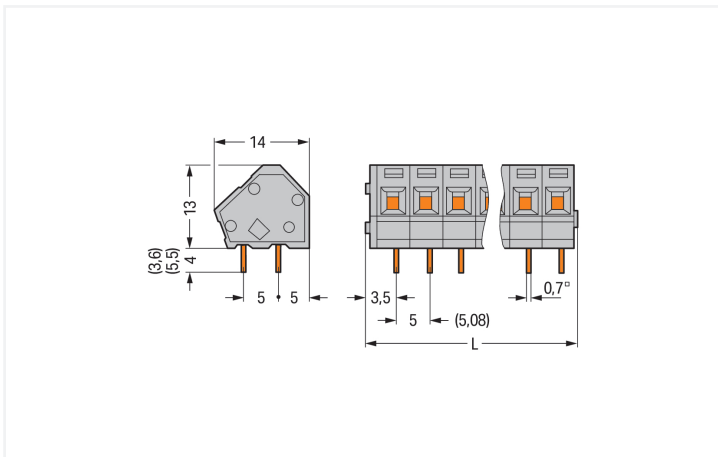

Dimensions in mm

$L = (\text{pole no.} \times \text{pin spacing}) + 2.3 \text{ mm}$

## PCB terminal block, 236 Series, operating tool

Our PCB terminal block (item number 236-403/332-000) ensures effortless electrical installations. It is perfect for custom installations with different mounting types. Strip lengths must be between 5 and 6 mm when connecting conductors to this PCB terminal block. This product features one conductor terminal and utilizes CAGE CLAMP®. Our proven universal connection known as CAGE CLAMP® is the industry standard when it comes to connection technology and electrical interconnections. The item's dimensions are (17.3 x 18.5 x 14) mm (width x height x depth). Depending on the conductor type, this PCB terminal block is designed for conductor cross sections ranging from 0.08 mm<sup>2</sup> to 2.5 mm<sup>2</sup>.

Tin is used for coating the contact surfaces. An operating tool is used to operate this PCB terminal block. The PCB terminal block is designed for THT soldering. The conductor is designed to be inserted at an angle of 45°..

## Notes

Variants:  	Other pole numbers Versions for Ex e II and Ex i Other colors Mixed-color PCB connector strips Direct marking Solder pin length: 3.6 mm Solder pin length: 5.5 mm Other versions (or variants) can be requested from WAGO Sales or configured at <a href="https://configurator.wago.com/">https://configurator.wago.com/</a> .
-------------------	---

## Electrical data

Ratings per	IEC/EN 60664-1			Approvals per	UL 1059		
Overvoltage category	III	III	II	Use group	B	C	D
Pollution degree	3	2	2	Rated voltage	300 V	-	300 V
Nominal voltage	250 V	320 V	630 V	Rated current	15 A	-	10 A
Rated impulse withstand voltage	4 kV	4 kV	4 kV				
Rated current	24 A	24 A	24 A				

Approvals per	CSA		
Use group	B	C	D
Rated voltage	300 V	-	300 V
Rated current	15 A	-	10 A

## Connection Data

Clamping units	3	<b>Connection 1</b>	
Total number of potentials	3	Connection technology	CAGE CLAMP®
Number of connection types	1	Actuation type	Operating tool
Number of levels	1	Solid conductor	0.08 ... 2.5 mm <sup>2</sup> / 28 ... 12 AWG
		Fine-stranded conductor	0.08 ... 2.5 mm <sup>2</sup> / 28 ... 12 AWG
		Fine-stranded conductor; with insulated ferrule	0.25 ... 1.5 mm <sup>2</sup>
		Fine-stranded conductor; with un-insulated ferrule	0.25 ... 1.5 mm <sup>2</sup>
		Note (conductor cross-section)	12 AWG: THHN, THWN
		Strip length	5 ... 6 mm / 0.2 ... 0.24 inches
		Conductor connection direction to PCB	45 °
		Pole number	3

## Physical data

Pin spacing	5/5.08 mm / 0.197/0.2 inches
Width	17.3 mm / 0.681 inches
Height	18.5 mm / 0.728 inches
Height from the surface	13 mm / 0.512 inches
Depth	14 mm / 0.551 inches
Solder pin length	5.5 mm
Solder pin dimensions	0.7 x 0.7 mm
!	1.1 <sup>(+0.1)</sup> mm

### PCB contact

PCB contact	THT
Solder pin arrangement	over the entire terminal strip (in-line)
Number of solder pins per potential	2

### Material data

Note (material data)	<a href="#">Information on material specifications can be found here</a>
Color	gray
Material group	I
Insulation material (main housing)	Polyamide (PA66)
Flammability class per UL94	V0
Clamping spring material	Chrome-nickel spring steel (CrNi)
Contact material	Electrolytic copper (E <sub>cu</sub> )
Contact Plating	Tin
Fire load	0.04 MJ
Weight	2.8 g

### Environmental requirements

Limit temperature range	-60 ... +105 °C
-------------------------	-----------------

### Commercial data

Product Group	4 (Printed Circuit Connectors)
PU (SPU)	280 (70) pcs
Packaging type	Box
Country of origin	CH
GTIN	4044918775991
Customs tariff number	85369010000

### Product Classification

UNSPSC	39121409
eCl@ss 10.0	27-44-04-01
eCl@ss 9.0	27-44-04-01
ETIM 9.0	EC002643
ETIM 10.0	EC002643
ECCN	NO US CLASSIFICATION

### Environmental Product Compliance

RoHS Compliance Status	Compliant, No Exemption
------------------------	-------------------------

### Approvals / Certificates

#### General approvals



Approval	Standard	Certificate Name
CSA DEKRA Certification B.V.	C22.2 No. 158	1673957
UL Underwriters Laboratories Inc.	UL 1059	UL-US-2406095-0

#### Approvals for marine applications



Approval	Standard	Certificate Name
BV Bureau Veritas S.A.	IEC 60998	11915/E0 BV

## Downloads

### Environmental Product Compliance

Compliance Search	
Environmental Product Compliance 236-403/332-000	<a href="#">↓</a>

## Documentation

Additional Information			
Technical Section	03.04.2019	pdf 2027.26 KB	<a href="#">↓</a>
Gebrückte Klemmen- leisten für Leiterplatten		pdf 303.71 KB	<a href="#">↓</a>

## CAD/CAE-Data

CAD data	
2D/3D Models 236-403/332-000	<a href="#">↓</a>

CAE data	
EPLAN Data Portal 236-403/332-000	<a href="#">↓</a>
ZUKEN Portal 236-403/332-000	<a href="#">↓</a>

PCB Design	
Symbol and Footprint via SamacSys 236-403/332-000	<a href="#">↓</a>
Symbol and Footprint via Ultra Librarian 236-403/332-000	<a href="#">↓</a>

## 1 Compatible Products

















### 1.1 Optional Accessories

#### 1.1.1 Ferrule

##### 1.1.1.1 Ferrule









<p><b>Item No.: 216-301</b> Ferrule; Sleeve for 0.25 mm<sup>2</sup> / AWG 24; insulated; electro-tin plated; yellow</p>	<p><b>Item No.: 216-321</b> Ferrule; Sleeve for 0.25 mm<sup>2</sup> / AWG 24; insulated; electro-tin plated; yellow</p>	<p><b>Item No.: 216-151</b> Ferrule; Sleeve for 0.25 mm<sup>2</sup> / AWG 24; uninsulated; electro-tin plated</p>	<p><b>Item No.: 216-131</b> Ferrule; Sleeve for 0.25 mm<sup>2</sup> / AWG 24; uninsulated; electro-tin plated; silver-colored</p>
<p><b>Item No.: 216-302</b> Ferrule; Sleeve for 0.34 mm<sup>2</sup> / 22 AWG; insulated; electro-tin plated; light turquoise</p>	<p><b>Item No.: 216-322</b> Ferrule; Sleeve for 0.34 mm<sup>2</sup> / 22 AWG; insulated; electro-tin plated; light turquoise</p>	<p><b>Item No.: 216-132</b> Ferrule; Sleeve for 0.34 mm<sup>2</sup> / AWG 24; uninsulated; electro-tin plated</p>	<p><b>Item No.: 216-152</b> Ferrule; Sleeve for 0.34 mm<sup>2</sup> / AWG 24; uninsulated; electro-tin plated</p>
<p><b>Item No.: 216-201</b> Ferrule; Sleeve for 0.5 mm<sup>2</sup> / 20 AWG; insulated; electro-tin plated; electrolytic copper; acc. to DIN 46228, Part 4/09.90; white</p>	<p><b>Item No.: 216-241</b> Ferrule; Sleeve for 0.5 mm<sup>2</sup> / 20 AWG; insulated; electro-tin plated; electrolytic copper; gastight crimped; acc. to DIN 46228, Part 4/09.90; white</p>	<p><b>Item No.: 216-221</b> Ferrule; Sleeve for 0.5 mm<sup>2</sup> / 20 AWG; insulated; electro-tin plated; white</p>	<p><b>Item No.: 216-141</b> Ferrule; Sleeve for 0.5 mm<sup>2</sup> / 20 AWG; uninsulated; electro-tin plated; electrolytic copper; gastight crimped; acc. to DIN 46228, Part 1/08.92</p>

1.1.1.1 Ferrule

 <p><b>Item No.: 216-101</b> Ferrule; Sleeve for 0.5 mm<sup>2</sup> / AWG 22; un-insulated; electro-tin plated; silver-colored</p>	 <p><b>Item No.: 216-121</b> Ferrule; Sleeve for 0.5 mm<sup>2</sup> / AWG 22; un-insulated; electro-tin plated; silver-colored</p>	 <p><b>Item No.: 216-242</b> Ferrule; Sleeve for 0.75 mm<sup>2</sup> / 18 AWG; insulated; electro-tin plated; electrolytic copper; gastight crimped; acc. to DIN 46228, Part 4/09.90; gray</p>	 <p><b>Item No.: 216-262</b> Ferrule; Sleeve for 0.75 mm<sup>2</sup> / 18 AWG; insulated; electro-tin plated; electrolytic copper; gastight crimped; acc. to DIN 46228, Part 4/09.90; gray</p>
 <p><b>Item No.: 216-202</b> Ferrule; Sleeve for 0.75 mm<sup>2</sup> / 18 AWG; insulated; electro-tin plated; gray</p>	 <p><b>Item No.: 216-222</b> Ferrule; Sleeve for 0.75 mm<sup>2</sup> / 18 AWG; insulated; electro-tin plated; gray</p>	 <p><b>Item No.: 216-142</b> Ferrule; Sleeve for 0.75 mm<sup>2</sup> / 18 AWG; un-insulated; electro-tin plated; electrolytic copper; gastight crimped; acc. to DIN 46228, Part 1/08.92</p>	 <p><b>Item No.: 216-102</b> Ferrule; Sleeve for 0.75 mm<sup>2</sup> / AWG 20; un-insulated; electro-tin plated; silver-colored</p>
 <p><b>Item No.: 216-122</b> Ferrule; Sleeve for 0.75 mm<sup>2</sup> / AWG 20; un-insulated; electro-tin plated; silver-colored</p>	 <p><b>Item No.: 216-243</b> Ferrule; Sleeve for 1 mm<sup>2</sup> / AWG 18; insulated; electro-tin plated; electrolytic copper; gastight crimped; acc. to DIN 46228, Part 4/09.90; red</p>	 <p><b>Item No.: 216-263</b> Ferrule; Sleeve for 1 mm<sup>2</sup> / AWG 18; insulated; electro-tin plated; electrolytic copper; gastight crimped; acc. to DIN 46228, Part 4/09.90; red</p>	 <p><b>Item No.: 216-203</b> Ferrule; Sleeve for 1 mm<sup>2</sup> / AWG 18; insulated; electro-tin plated; red</p>
 <p><b>Item No.: 216-223</b> Ferrule; Sleeve for 1 mm<sup>2</sup> / AWG 18; un-insulated; electro-tin plated; red</p>	 <p><b>Item No.: 216-103</b> Ferrule; Sleeve for 1 mm<sup>2</sup> / AWG 18; un-insulated; electro-tin plated</p>	 <p><b>Item No.: 216-143</b> Ferrule; Sleeve for 1 mm<sup>2</sup> / AWG 18; un-insulated; electro-tin plated; electrolytic copper; gastight crimped; acc. to DIN 46228, Part 1/08.92</p>	 <p><b>Item No.: 216-123</b> Ferrule; Sleeve for 1 mm<sup>2</sup> / AWG 18; un-insulated; electro-tin plated; silver-colored</p>
 <p><b>Item No.: 216-204</b> Ferrule; Sleeve for 1.5 mm<sup>2</sup> / AWG 16; insulated; electro-tin plated; black</p>	 <p><b>Item No.: 216-224</b> Ferrule; Sleeve for 1.5 mm<sup>2</sup> / AWG 16; insulated; electro-tin plated; black</p>	 <p><b>Item No.: 216-244</b> Ferrule; Sleeve for 1.5 mm<sup>2</sup> / AWG 16; insulated; electro-tin plated; electrolytic copper; gastight crimped; acc. to DIN 46228, Part 4/09.90; black</p>	 <p><b>Item No.: 216-264</b> Ferrule; Sleeve for 1.5 mm<sup>2</sup> / AWG 16; insulated; electro-tin plated; electrolytic copper; gastight crimped; acc. to DIN 46228, Part 4/09.90; black</p>
 <p><b>Item No.: 216-284</b> Ferrule; Sleeve for 1.5 mm<sup>2</sup> / AWG 16; insulated; electro-tin plated; electrolytic copper; gastight crimped; acc. to DIN 46228, Part 4/09.90; black</p>	 <p><b>Item No.: 216-124</b> Ferrule; Sleeve for 1.5 mm<sup>2</sup> / AWG 16; un-insulated; electro-tin plated</p>	 <p><b>Item No.: 216-144</b> Ferrule; Sleeve for 1.5 mm<sup>2</sup> / AWG 16; un-insulated; electro-tin plated; electrolytic copper; gastight crimped; acc. to DIN 46228, Part 1/08.92; silver-colored</p>	 <p><b>Item No.: 216-104</b> Ferrule; Sleeve for 1.5 mm<sup>2</sup> / AWG 16; un-insulated; electro-tin plated; silver-colored</p>

1.1.2 Marking

1.1.2.1 Marking strip

 <p><b>Item No.: 210-332/500-202</b> Marking strips; as a DIN A4 sheet; MARKED; 1-16 (160x); Height of marker strip: 3 mm; Strip length 182 mm; Horizontal marking; Self-adhesive; white</p>	 <p><b>Item No.: 210-332/508-202</b> Marking strips; as a DIN A4 sheet; MARKED; 1-16 (160x); Height of marker strip: 3 mm; Strip length 182 mm; Horizontal marking; Self-adhesive; white</p>	 <p><b>Item No.: 210-332/500-205</b> Marking strips; as a DIN A4 sheet; MARKED; 1-32 (80x); Height of marker strip: 3 mm; Strip length 182 mm; Horizontal marking; Self-adhesive; white</p>	 <p><b>Item No.: 210-332/508-205</b> Marking strips; as a DIN A4 sheet; MARKED; 1-32 (80x); Height of marker strip: 3 mm; Strip length 182 mm; Horizontal marking; Self-adhesive; white</p>
 <p><b>Item No.: 210-332/500-204</b> Marking strips; as a DIN A4 sheet; MARKED; 17-32 (160x); Height of marker strip: 3 mm; Strip length 182 mm; Horizontal marking; Self-adhesive; white</p>	 <p><b>Item No.: 210-332/508-204</b> Marking strips; as a DIN A4 sheet; MARKED; 17-32 (160x); Height of marker strip: 3 mm; Strip length 182 mm; Horizontal marking; Self-adhesive; white</p>	 <p><b>Item No.: 210-332/500-206</b> Marking strips; as a DIN A4 sheet; MARKED; 33-48 (160x); Height of marker strip: 3 mm; Strip length 182 mm; Horizontal marking; Self-adhesive; white</p>	 <p><b>Item No.: 210-332/508-206</b> Marking strips; as a DIN A4 sheet; MARKED; 33-48 (160x); Height of marker strip: 3 mm; Strip length 182 mm; Horizontal marking; Self-adhesive; white</p>

### 1.1.3 Stickers with operating instructions

#### 1.1.3.1 Stickers with operating instructions



**Item No.: 210-191**

Stickers for operating instructions; for PCB terminal blocks; 236 Series

### 1.1.4 Test and measurement

#### 1.1.4.1 Testing accessories



**Item No.: 231-127**

Testing plug module with contact stud; for 236 Series; Pin spacing 5 mm / 0.197 in; 2,50 mm<sup>2</sup>; gray



**Item No.: 231-128**

Testing plug module with contact stud; Pin spacing 5.08 mm / 0.2 in; 2,50 mm<sup>2</sup>; orange

### 1.1.5 Tool

#### 1.1.5.1 Operating tool



**Item No.: 210-658**

Operating tool; Blade: 3.5 x 0.5 mm; with a partially insulated shaft; angled; short; multicoloured



**Item No.: 210-720**

Operating tool; Blade: 3.5 x 0.5 mm; with a partially insulated shaft; multicoloured



**Item No.: 210-657**

Operating tool; Blade: 3.5 x 0.5 mm; with a partially insulated shaft; short; multicoloured



**Item No.: 236-335**

Operating tool; gray



**Item No.: 236-332**

Operating tool; natural

### Installation Notes

#### Conductor termination



Inserting a conductor via 3.5 mm screwdriver. Screwdriver actuation parallel to conductor entry

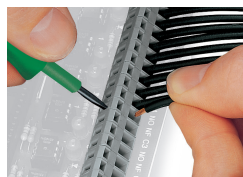

Inserting a conductor via 3.5 mm screwdriver. Screwdriver actuation perpendicular to conductor entry

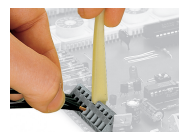

Inserting a conductor via operating tool.



Compared to standard screwdrivers, these operating tools are far more convenient for wiring PCB terminal strips at factory.

### Installation



PCB Terminal Strips placed behind each other save space – staggering them by half the pin spacing simplifies subsequent wiring of the first row.

## Installation



Combining PCB terminal blocks with different pin spacing.

## Marking



Optional: Labeling via factory direct marking.



Optional: Labeling with self-adhesive marking strips possible