

Data Sheet | Item Number: 816-103

2-conductor PCB terminal block; 1.5 mm²; Pin spacing 5 mm; 3-pole; Push-in CAGE CLAMP®; gray

<https://www.wago.com/816-103>



Color: ■ gray

Similar to illustration

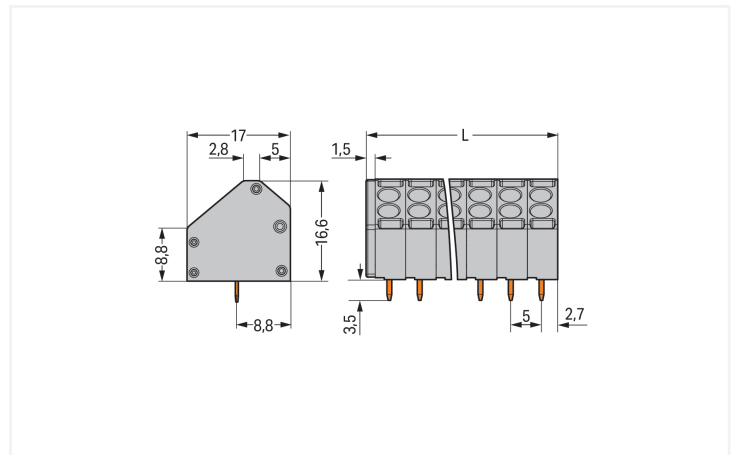
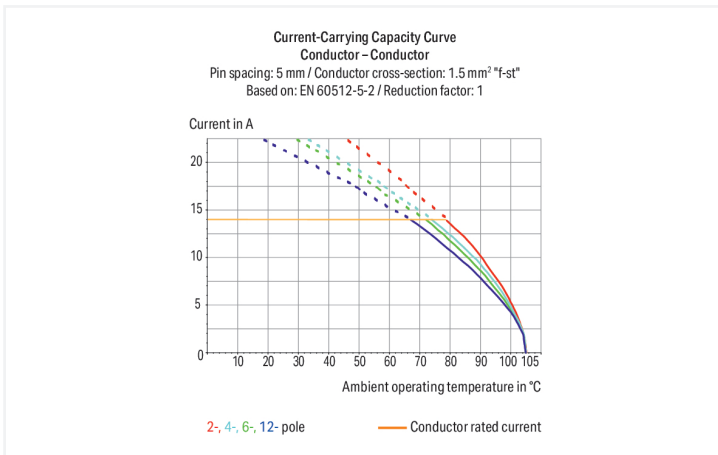
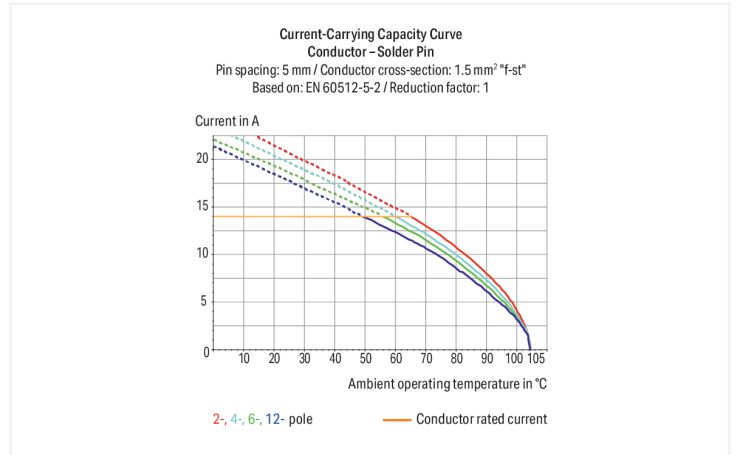

PCB terminal block, 816 Series, solder pin dimensions 0.8 x 0.5 mm

Our PCB terminal block (item number 816-103) simplifies electrical installations. You can rely on proven safety with these PCB terminal blocks, perfect for a wide variety of applications when designing your devices. Ensure that the strip lengths are between 9 and 10 mm when connecting conductors to this PCB terminal block. Featuring one conductor terminal along with Push-in CAGE CLAMP®, this connector delivers reliable performance. Our Push-in CAGE CLAMP® is a universal, maintenance-free connection solution for all conductor types, boasting a key feature: It allows direct insertion of both solid and fine-stranded conductors with ferrules without needing tools. No preparation is required; for example, crimping the conductor's ferrule is not necessary. The item's dimensions are (16.5 x 20.1 x 17) mm (width x height x depth). This PCB terminal block is suitable for conductor cross sections ranging from 0.2 mm² to 1.5 mm².

Tin is used for coating the contact surfaces. This PCB terminal block is operated with an operating tool. The PCB terminal block is designed for THT soldering. Insert the conductor into the board at a 45° angle..

Notes

Variants:	Other pole numbers Other colors Mixed-color PCB connector strips Direct marking Other versions (or variants) can be requested from WAGO Sales or configured at https://configurator.wago.com/ .
-----------	--

Electrical data

Ratings per	IEC/EN 60664-1			Approvals per	UL 1059		
Overvoltage category	III	III	II	Use group	B	C	D
Pollution degree	3	2	2	Rated voltage	300 V	-	300 V
Nominal voltage	320 V	320 V	630 V	Rated current	10 A	-	10 A
Rated impulse withstand voltage	4 kV	4 kV	4 kV				
Rated current	14 A	14 A	14 A				

Approvals per	CSA		
Use group	B	C	D
Rated voltage	300 V	-	300 V
Rated current	8 A	-	-

Connection Data

Clamping units	6	Connection 1	
Total number of potentials	3	Connection technology	Push-in CAGE CLAMP®
Number of connection types	1	Actuation type	Operating tool
Number of levels	2	Solid conductor	0.2 ... 1.5 mm ² / 24 ... 16 AWG
		Fine-stranded conductor	0.2 ... 1.5 mm ² / 24 ... 16 AWG
		Fine-stranded conductor; with insulated ferrule	0.2 ... 1 mm ²
		Fine-stranded conductor; with uninsulated ferrule	0.2 ... 1.5 mm ²
		Strip length	9 ... 10 mm / 0.35 ... 0.39 inches
		Conductor connection direction to PCB	45 °
		Pole number	3

Physical data

Pin spacing	5 mm / 0.197 inches
Width	16.5 mm / 0.65 inches
Height	20.1 mm / 0.791 inches
Height from the surface	16.6 mm / 0.654 inches
Depth	17 mm / 0.669 inches
Solder pin length	3.5 mm
Solder pin dimensions	0.8 x 0.5 mm
!	1.1 (+0.1) mm

PCB contact

PCB contact	THT
Solder pin arrangement	over the entire terminal strip (in-line)
Number of solder pins per potential	1

Material data

Note (material data)	Information on material specifications can be found here
Color	gray
Material group	I
Insulation material (main housing)	Polyamide (PA66)
Flammability class per UL94	V0
Clamping spring material	Chrome-nickel spring steel (CrNi)
Contact material	Copper alloy
Contact Plating	Tin
Fire load	0.073 MJ
Weight	3.8 g

Environmental requirements

Limit temperature range	-60 ... +105 °C
-------------------------	-----------------

Commercial data

Product Group	4 (Printed Circuit Connectors)
PU (SPU)	224 (112) pcs
Packaging type	Box
Country of origin	CH
GTIN	4045454732066
Customs tariff number	85369010000

Product Classification

UNSPSC	39121409
eCl@ss 10.0	27-44-04-01
eCl@ss 9.0	27-44-04-01
ETIM 9.0	EC002643
ETIM 10.0	EC002643
ECCN	NO US CLASSIFICATION

Environmental Product Compliance

RoHS Compliance Status	Compliant, No Exemption
------------------------	-------------------------

Approvals / Certificates

General approvals



General approvals

UR Underwriters Laboratories Inc.	UL 1059	E45172
---	---------	--------

Approval	Standard	Certificate Name
CCA DEKRA Certification B.V.	EN 60947	NTR NL 7057
CCA DEKRA Certification B.V.	EN 60947	2158696.01
CSA DEKRA Certification B.V.	C22.2	1132097

Declarations of conformity and manufacturer's declarations

Approval	Standard	Certificate Name
EU-Declaration of Confor- mity WAGO GmbH & Co. KG	-	-
UK-Declaration of Confor- mity WAGO GmbH & Co. KG	-	-

Downloads

Environmental Product Compliance

Compliance Search
Environmental Product Compliance 816-103 

Documentation

Additional Information
Technical Section 03.04.2019 pdf 2027.26 KB 

CAD/CAE-Data

CAD data
2D/3D Models 816-103 

CAE data
ZUKEN Portal 816-103 

PCB Design

Symbol and Footprint via SamacSys 816-103 
--

Symbol and Footprint via Ultra Librarian 816-103 
--

1 Compatible Products

1.1 Optional Accessories

1.1.1 Ferrule

1.1.1.1 Ferrule



Item No.: 216-241
Ferrule; Sleeve for 0.5 mm² / 20 AWG; in-
sulated; electro-tin plated; electrolytic
copper; gastight crimped; acc. to DIN
46228, Part 4/09.90; white

Item No.: 216-141
Ferrule; Sleeve for 0.5 mm² / 20 AWG; un-
insulated; electro-tin plated; electrolytic
copper; gastight crimped; acc. to DIN
46228, Part 1/08.92

Item No.: 216-242
Ferrule; Sleeve for 0.75 mm² / 18 AWG; in-
sulated; electro-tin plated; electrolytic
copper; gastight crimped; acc. to DIN
46228, Part 4/09.90; gray

Item No.: 216-262
Ferrule; Sleeve for 0.75 mm² / 18 AWG; in-
sulated; electro-tin plated; electrolytic
copper; gastight crimped; acc. to DIN
46228, Part 4/09.90; gray

1.1.1.1 Ferrule

Item No.: 216-142

Ferrule; Sleeve for 0.75 mm² / 18 AWG; uninsulated; electro-tin plated; electrolytic copper; gastight crimped; acc. to DIN 46228, Part 1/08.92

Item No.: 216-243

Ferrule; Sleeve for 1 mm² / AWG 18; insulated; electro-tin plated; electrolytic copper; gastight crimped; acc. to DIN 46228, Part 4/09.90; red

Item No.: 216-263

Ferrule; Sleeve for 1 mm² / AWG 18; insulated; electro-tin plated; electrolytic copper; gastight crimped; acc. to DIN 46228, Part 4/09.90; red

Item No.: 216-143

Ferrule; Sleeve for 1 mm² / AWG 18; uninsulated; electro-tin plated; electrolytic copper; gastight crimped; acc. to DIN 46228, Part 1/08.92

Item No.: 216-144

Ferrule; Sleeve for 1.5 mm² / AWG 16; uninsulated; electro-tin plated; electrolytic copper; gastight crimped; acc. to DIN 46228, Part 1/08.92; silver-colored

1.1.2 Marking

1.1.2.1 Marking strip

Item No.: 210-833

Marking strips; 25 m on roll; 6 mm wide; plain; Self-adhesive; white

Item No.: 210-332/500-202

Marking strips; as a DIN A4 sheet; MARKED; 1-16 (160x); Height of marker strip: 3 mm; Strip length 182 mm; Horizontal marking; Self-adhesive; white

Item No.: 210-332/500-205

Marking strips; as a DIN A4 sheet; MARKED; 1-32 (80x); Height of marker strip: 3 mm; Strip length 182 mm; Horizontal marking; Self-adhesive; white

Item No.: 210-332/500-204

Marking strips; as a DIN A4 sheet; MARKED; 17-32 (160x); Height of marker strip: 3 mm; Strip length 182 mm; Horizontal marking; Self-adhesive; white

Item No.: 210-332/500-206

Marking strips; as a DIN A4 sheet; MARKED; 33-48 (160x); Height of marker strip: 3 mm; Strip length 182 mm; Horizontal marking; Self-adhesive; white

1.1.3 Tool

1.1.3.1 Operating tool

Item No.: 210-719

Operating tool; Blade: 2.5 x 0.4 mm; with a partially insulated shaft

Item No.: 210-648

Operating tool; Blade: 2.5 x 0.4 mm; with a partially insulated shaft; angled; short

Item No.: 210-647

Operating tool; Blade: 2.5 x 0.4 mm; with a partially insulated shaft; multicoloured

Installation Notes

Conductor termination

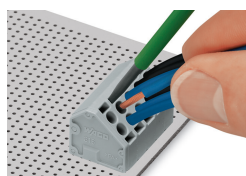

Open the clamping unit via screwdriver (3.5 mm blade) to insert/remove fine-stranded conductors.
Push in solid and ferruled, fine-stranded conductors until fully inserted.