

Data Sheet | Item Number: 235-402/331-000

PCB terminal block; push-button; 1.5 mm²; Pin spacing 5/5.08 mm; 2-pole; Push-in CAGE CLAMP®; gray

<https://www.wago.com/235-402/331-000>

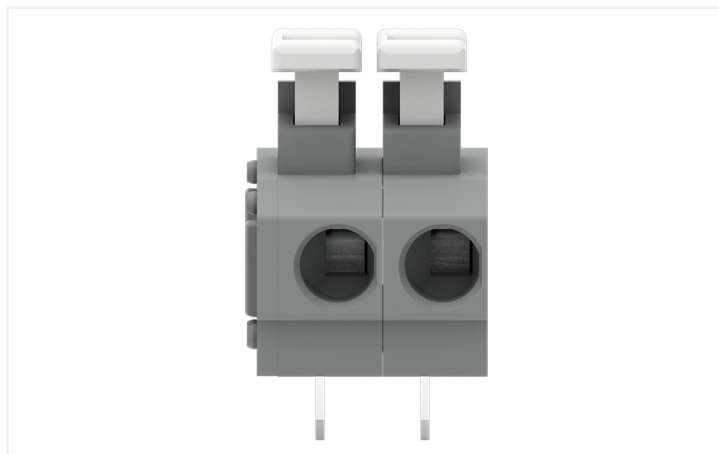

Color: ■ gray

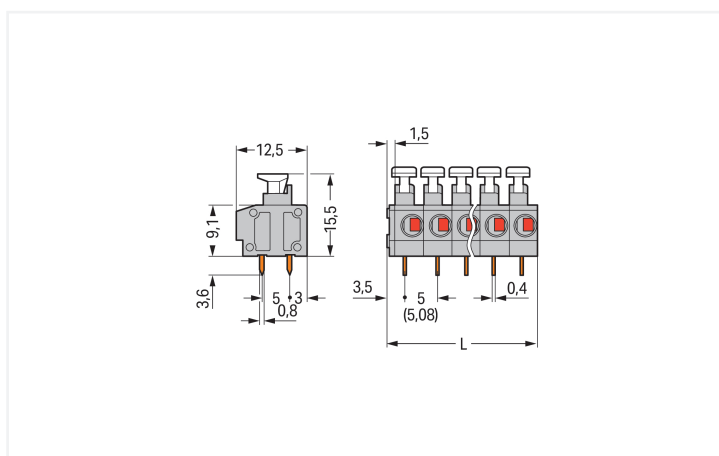
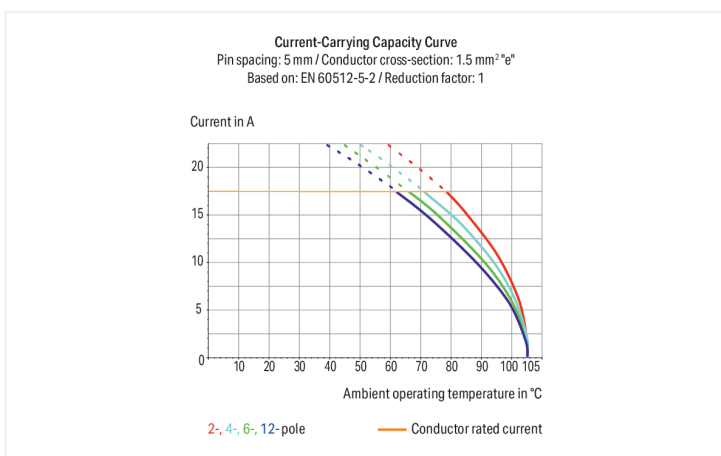
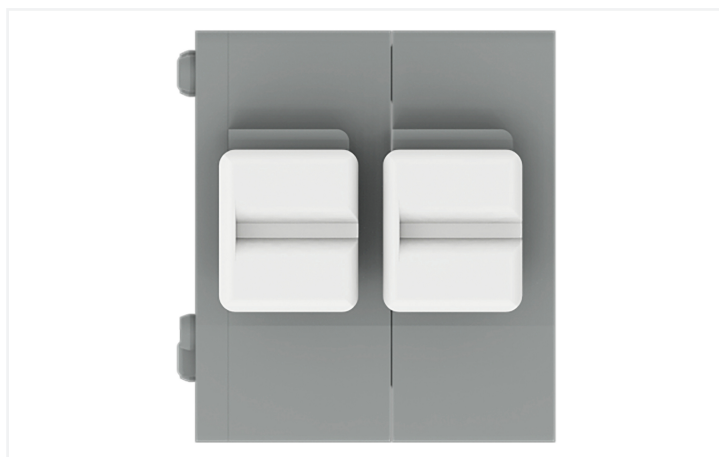

PCB terminal block, 235 Series, Push-in CAGE CLAMP®

This PCB terminal block (item number 235-402/331-000) is designed for quick and simple connections. It offers the flexibility needed for different mounting types. Ensure that the strip lengths are between 9 and 10 mm when connecting conductors to this PCB terminal block. This product features one conductor terminal and utilizes Push-in CAGE CLAMP®. Push-in CAGE CLAMP® connection technology is ideal for connecting all conductor types.

It allows direct insertion of both solid and fine-stranded conductors with ferrules without needing to use any tools—all thanks to its pluggable design. Dimensions: (11.5 x 19.1 x 12.5) mm (width x height x depth). Depending on the conductor type, this PCB terminal block is suitable for conductor cross sections ranging from 0.2 mm² to 1.5 mm².

The contact surface is coated with tin. This PCB terminal block is operated with a push-button. The PCB terminal block is designed for THT soldering. Insert the conductor into the board at a 0° angle..

Notes	
Variants:	Other pole numbers Other colors Terminal strips with 7.5/7.62 mm and 10/10.16 mm pin spacing Mixed-color PCB connector strips Direct marking Other versions (or variants) can be requested from WAGO Sales or configured at https://configurator.wago.com/ .

Electrical data

Ratings per	IEC/EN 60664-1			Approvals per	UL 1059		
Overvoltage category	III	III	II	Use group	B	C	D
Pollution degree	3	2	2	Rated voltage	300 V	-	300 V
Nominal voltage	250 V	320 V	630 V	Rated current	10 A	-	10 A
Rated impulse withstand voltage	4 kV	4 kV	4 kV				
Rated current	17.5 A	17.5 A	17.5 A				

Approvals per	CSA		
Use group	B	C	D
Rated voltage	300 V	-	-
Rated current	15 A	-	-

Connection Data

Clamping units	2	Connection 1	
Total number of potentials	2	Connection technology	Push-in CAGE CLAMP®
Number of connection types	1	Actuation type	Push-button
Number of levels	1	Solid conductor	0.2 ... 1.5 mm ² / 20 ... 14 AWG
		Fine-stranded conductor	0.75 ... 1.5 mm ² / 20 ... 14 AWG
		Fine-stranded conductor; with insulated ferrule	0.25 ... 1 mm ²
		Fine-stranded conductor; with uninsulated ferrule	0.25 ... 1 mm ²
		Note (conductor cross-section)	Fine-stranded conductor 0.25 ... 0.5 mm ² (I max. 2 A) Fine-stranded conductor 0.75 ... 1.5 mm ² (I max. 6 A)
		Strip length	9 ... 10 mm / 0.35 ... 0.39 inches
		Conductor connection direction to PCB	0°
		Pole number	2

Physical data

Pin spacing	5/5.08 mm / 0.197/0.2 inches
Width	11.5 mm / 0.453 inches
Height	19.1 mm / 0.752 inches
Height from the surface	15.5 mm / 0.61 inches
Depth	12.5 mm / 0.492 inches
Solder pin length	3.6 mm
Solder pin dimensions	0.4 x 0.8 mm
!	1 ^(+0.1) mm

PCB contact

PCB contact	THT
Solder pin arrangement	over the entire terminal strip (in-line)
Number of solder pins per potential	2

Material data

Note (material data)	Information on material specifications can be found here
Color	gray
Material group	I
Insulation material (main housing)	Polyamide (PA66)
Flammability class per UL94	V0
Clamping spring material	Chrome-nickel spring steel (CrNi)
Contact material	Electrolytic copper (E _{Cu})
Contact Plating	Tin
Fire load	0.032 MJ
Weight	1.6 g

Environmental requirements

Limit temperature range	-60 ... +105 °C
-------------------------	-----------------

Commercial data

Product Group	4 (Printed Circuit Connectors)
PU (SPU)	420 (105) pcs
Packaging type	Box
Country of origin	CN
GTIN	4055143258616
Customs tariff number	85369010000

Product Classification

UNSPSC	39121409
eCl@ss 10.0	27-44-04-01
eCl@ss 9.0	27-44-04-01
ETIM 9.0	EC002643
ETIM 10.0	EC002643
ECCN	NO US CLASSIFICATION

Environmental Product Compliance

RoHS Compliance Status

Compliant, No Exemption

Approvals / Certificates

General approvals



Approval	Standard	Certificate Name
CCA DEKRA Certification B.V.	EN 60947	NTR NL-7144
CCA DEKRA Certification B.V.	EN 60998	NTR NL 6919
CSA DEKRA Certification B.V.	C22.2	1673956
KEMA/KEUR DEKRA Certification B.V.	EN 60947	2160584.38

Declarations of conformity and manufacturer's declarations

Approval	Standard	Certificate Name
EU-Declaration of Conformity WAGO GmbH & Co. KG	-	-
UK-Declaration of Conformity WAGO GmbH & Co. KG	-	-

Approvals for marine applications



Approval	Standard	Certificate Name
ABS American Bureau of Shipping	-	24-0095975-PDA
DNV DNV GL SE	-	TAE000016Z
PRS Polski Rejestr Statków	-	TE/1095/880590/23

Downloads

Environmental Product Compliance

Compliance Search

Environmental Product
Compliance
235-402/331-000



Documentation

Additional Information

Technical Section

03.04.2019

pdf
2027.26 KB

CAD/CAE-Data

CAD data

2D/3D Models
235-402/331-000

CAE data

EPLAN Data Portal
235-402/331-000

ZUKEN Portal
235-402/331-000

PCB Design

Symbol and Footprint
via SamacSys
235-402/331-000

Symbol and Footprint
via Ultra Librarian
235-402/331-000

1 Compatible Products

1.1 Optional Accessories

1.1.1 Ferrule

1.1.1.1 Ferrule

<p>Item No.: 216-241 Ferrule; Sleeve for 0.5 mm² / 20 AWG; insulated; electro-tin plated; electrolytic copper; gastight crimped; acc. to DIN 46228, Part 4/09.90; white</p>	<p>Item No.: 216-141 Ferrule; Sleeve for 0.5 mm² / 20 AWG; un-insulated; electro-tin plated; electrolytic copper; gastight crimped; acc. to DIN 46228, Part 1/08.92</p>	<p>Item No.: 216-242 Ferrule; Sleeve for 0.75 mm² / 18 AWG; insulated; electro-tin plated; electrolytic copper; gastight crimped; acc. to DIN 46228, Part 4/09.90; gray</p>	<p>Item No.: 216-262 Ferrule; Sleeve for 0.75 mm² / 18 AWG; insulated; electro-tin plated; electrolytic copper; gastight crimped; acc. to DIN 46228, Part 4/09.90; gray</p>
<p>Item No.: 216-142 Ferrule; Sleeve for 0.75 mm² / 18 AWG; uninsulated; electro-tin plated; electrolytic copper; gastight crimped; acc. to DIN 46228, Part 1/08.92</p>	<p>Item No.: 216-243 Ferrule; Sleeve for 1 mm² / AWG 18; insulated; electro-tin plated; electrolytic copper; gastight crimped; acc. to DIN 46228, Part 4/09.90; red</p>	<p>Item No.: 216-263 Ferrule; Sleeve for 1 mm² / AWG 18; insulated; electro-tin plated; electrolytic copper; gastight crimped; acc. to DIN 46228, Part 4/09.90; red</p>	<p>Item No.: 216-143 Ferrule; Sleeve for 1 mm² / AWG 18; uninsulated; electro-tin plated; electrolytic copper; gastight crimped; acc. to DIN 46228, Part 1/08.92</p>

1.1.2 Marking

1.1.2.1 Marking strip

<p>Item No.: 210-332/500-202 Marking strips; as a DIN A4 sheet; MARKED; 1-16 (160x); Height of marker strip: 3 mm; Strip length 182 mm; Horizontal marking; Self-adhesive; white</p>	<p>Item No.: 210-332/508-202 Marking strips; as a DIN A4 sheet; MARKED; 1-16 (160x); Height of marker strip: 3 mm; Strip length 182 mm; Horizontal marking; Self-adhesive; white</p>	<p>Item No.: 210-332/500-205 Marking strips; as a DIN A4 sheet; MARKED; 1-32 (80x); Height of marker strip: 3 mm; Strip length 182 mm; Horizontal marking; Self-adhesive; white</p>	<p>Item No.: 210-332/508-205 Marking strips; as a DIN A4 sheet; MARKED; 1-32 (80x); Height of marker strip: 3 mm; Strip length 182 mm; Horizontal marking; Self-adhesive; white</p>
<p>Item No.: 210-332/500-204 Marking strips; as a DIN A4 sheet; MARKED; 17-32 (160x); Height of marker strip: 3 mm; Strip length 182 mm; Horizontal marking; Self-adhesive; white</p>	<p>Item No.: 210-332/508-204 Marking strips; as a DIN A4 sheet; MARKED; 17-32 (160x); Height of marker strip: 3 mm; Strip length 182 mm; Horizontal marking; Self-adhesive; white</p>	<p>Item No.: 210-332/500-206 Marking strips; as a DIN A4 sheet; MARKED; 33-48 (160x); Height of marker strip: 3 mm; Strip length 182 mm; Horizontal marking; Self-adhesive; white</p>	<p>Item No.: 210-332/508-206 Marking strips; as a DIN A4 sheet; MARKED; 33-48 (160x); Height of marker strip: 3 mm; Strip length 182 mm; Horizontal marking; Self-adhesive; white</p>

1.1.3 Tool

1.1.3.1 Operating tool



Item No.: 210-720

Operating tool; Blade: 3.5 x 0.5 mm; with a partially insulated shaft; multicoloured

Item No.: 210-657

Operating tool; Blade: 3.5 x 0.5 mm; with a partially insulated shaft; short; multicoloured

Installation Notes

Conductor termination

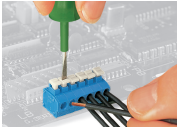

Inserting/removing fine-stranded conductors via push-button.

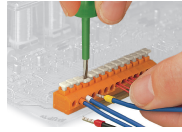

Insert/remove fine-stranded conductors with ferrules via push-button.

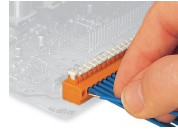

Insert solid conductors via push-in termination.

Installation

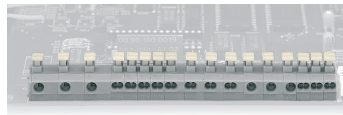
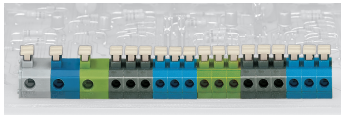

Combining 1- and 2-conductor terminal blocks with different pin spacing.

Testing

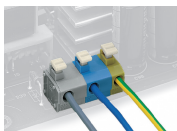

Application example: field-wiring terminal strip