

## Data Sheet | Item Number: 745-106

PCB terminal block; 4 mm<sup>2</sup>; Pin spacing 5 mm; 6-pole; CAGE CLAMP®; commoning option; gray

<https://www.wago.com/745-106>

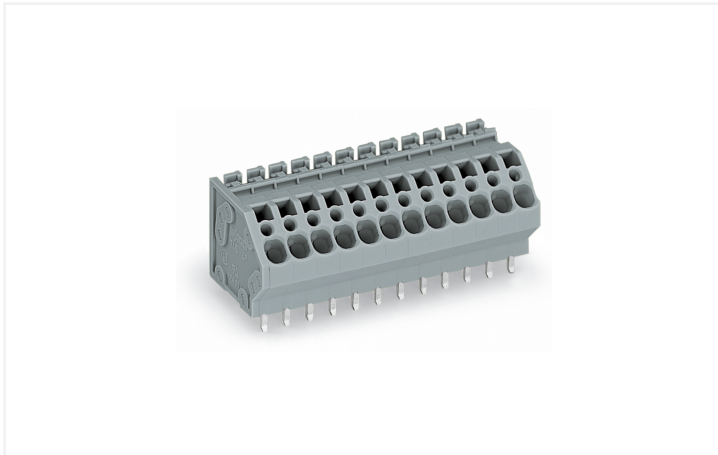

Color: ■ gray

Similar to illustration

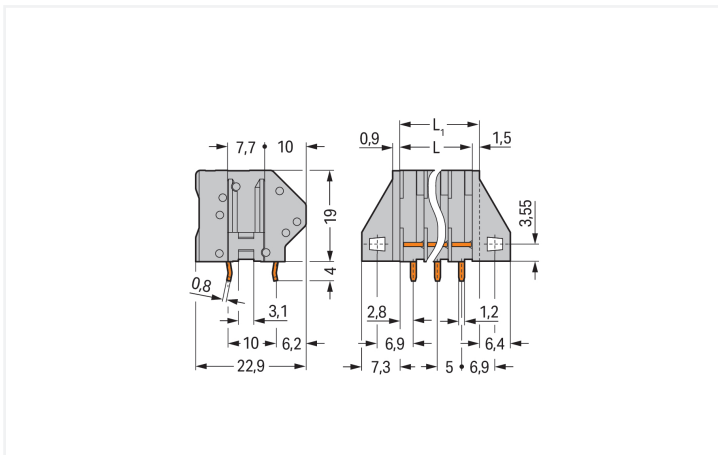

Dimensions in mm

$L = (\text{pole no.} - 1) \times \text{pin spacing} + 5 \text{ mm}$   
 $L_1 = L + 1.5 \text{ mm} \hat{=}$  version without mounting flange

### PCB terminal block, 745 Series, CAGE CLAMP®

Easily, quickly and safely connect conductors with this PCB terminal block (item number 745-106). It is a universal connector that can be used almost anywhere, for example, as a pluggable PCB connector, panel feedthrough header, connector for rail-mount terminal blocks, or a floating connector for different mounting methods. Ensure that the strip lengths are between 8 and 9 mm when connecting conductors to this PCB terminal block. Featuring one conductor terminal along with CAGE CLAMP®, this product is highly versatile. Our celebrated universal connection known as CAGE CLAMP® is the industry standard for connection technology and electrical interconnections. The dimensions are (31.5 x 23 x 22.9) mm (width x height x depth). This PCB terminal block is suitable for conductor cross sections ranging from 0.08 mm<sup>2</sup> to 4 mm<sup>2</sup>.

Tin is used for coating the contact surfaces. This PCB terminal block is operated with an operating tool. THT is used to assemble the PCB terminal block. The conductor is designed to be inserted at an angle of 45°.

## Notes

Variants:	Other pole numbers Versions for Ex e II and Ex i Other colors Mixed-color PCB connector strips Versions with mounting flanges Direct marking Other versions (or variants) can be requested from WAGO Sales or configured at <a href="https://configurator.wago.com/">https://configurator.wago.com/</a> .
-----------	---

## Electrical data

Ratings per	IEC/EN 60664-1			Approvals per	UL 1059		
Overvoltage category	III	III	II	Use group	B	C	D
Pollution degree	3	2	2	Rated voltage	300 V	-	300 V
Nominal voltage	320 V	320 V	630 V	Rated current	20 A	-	10 A
Rated impulse withstand voltage	4 kV	4 kV	4 kV				
Rated current	32 A	32 A	32 A				

Approvals per	CSA		
Use group	B	C	D
Rated voltage	300 V	-	300 V
Rated current	20 A	-	10 A

## Connection Data

Clamping units	6	<b>Connection 1</b>	
Total number of potentials	6	Connection technology	CAGE CLAMP®
Number of connection types	1	Actuation type	Operating tool
Number of levels	1	Solid conductor	0.08 ... 4 mm <sup>2</sup> / 28 ... 12 AWG
Number of jumper slots	1	Fine-stranded conductor	0.08 ... 4 mm <sup>2</sup> / 28 ... 12 AWG
		Fine-stranded conductor; with insulated ferrule	0.25 ... 2.5 mm <sup>2</sup>
		Fine-stranded conductor; with uninsulated ferrule	0.25 ... 2.5 mm <sup>2</sup>
		Strip length	8 ... 9 mm / 0.31 ... 0.35 inches
		Conductor connection direction to PCB	45 °
		Pole number	6

## Physical data

Pin spacing	5 mm / 0.197 inches
Width	31.5 mm / 1.24 inches
Height	23 mm / 0.906 inches
Height from the surface	19 mm / 0.748 inches
Depth	22.9 mm / 0.902 inches
Solder pin length	4 mm
Solder pin dimensions	0.8 x 1.2 mm
!	1.5 (+0.1) mm

### PCB contact

PCB contact	THT
Solder pin arrangement	over the entire terminal strip (in-line)
Number of solder pins per potential	2

### Material data

Note (material data)	<a href="#">Information on material specifications can be found here</a>
Color	gray
Material group	I
Insulation material (main housing)	Polyamide (PA66)
Flammability class per UL94	V0
Clamping spring material	Chrome-nickel spring steel (CrNi)
Contact material	Electrolytic copper (E <sub>cu</sub> )
Contact Plating	Tin
Fire load	0.205 MJ
Weight	12.5 g

### Environmental requirements

Limit temperature range	-60 ... +105 °C
-------------------------	-----------------

### Commercial data

Product Group	4 (Printed Circuit Connectors)
PU (SPU)	80 pcs
Packaging type	Box
Country of origin	PL
GTIN	4044918671071
Customs tariff number	85369010000

### Product Classification

UNSPSC	39121409
eCl@ss 10.0	27-44-04-01
eCl@ss 9.0	27-44-04-01
ETIM 9.0	EC002643
ETIM 10.0	EC002643
ECCN	NO US CLASSIFICATION

### Environmental Product Compliance

RoHS Compliance Status	Compliant, No Exemption
------------------------	-------------------------

### Approvals / Certificates

#### General approvals



#### General approvals

UR Underwriters Laboratories Inc.	UL 1059	E45172
---	---------	--------

Approval	Standard	Certificate Name
CCA DEKRA Certification B.V.	EN 60947	NTR NL-7095
CCA DEKRA Certification B.V.	EN 60947	71-112275
CSA DEKRA Certification B.V.	C22.2 No. 158	1604421

**Declarations of conformity and manufacturer's declarations**

Approval	Standard	Certificate Name
EU-Declaration of Confor- mity WAGO GmbH & Co. KG	-	-
UK-Declaration of Confor- mity WAGO GmbH & Co. KG	-	-

**Downloads**

**Environmental Product Compliance**



Compliance Search
Environmental Product Compliance 745-106 

**Documentation**

Additional Information			
Technical Section	03.04.2019	pdf 2027.26 KB	

**CAD/CAE-Data**

CAD data
2D/3D Models 745-106 

CAE data
EPLAN Data Portal 745-106 
ZUKEN Portal 745-106 

**PCB Design**

















Symbol and Footprint via SamacSys 745-106 
Symbol and Footprint via Ultra Librarian 745-106 

**1 Compatible Products**

**1.1 Optional Accessories**







**1.1.1 Ferrule**

**1.1.1.1 Ferrule**

 <p><b>Item No.: 216-241</b> Ferrule; Sleeve for 0.5 mm<sup>2</sup> / 20 AWG; insulated; electro-tin plated; electrolytic copper; gastight crimped; acc. to DIN 46228, Part 4/09.90; white</p>	 <p><b>Item No.: 216-141</b> Ferrule; Sleeve for 0.5 mm<sup>2</sup> / 20 AWG; un-insulated; electro-tin plated; electrolytic copper; gastight crimped; acc. to DIN 46228, Part 1/08.92</p>	 <p><b>Item No.: 216-242</b> Ferrule; Sleeve for 0.75 mm<sup>2</sup> / 18 AWG; insulated; electro-tin plated; electrolytic copper; gastight crimped; acc. to DIN 46228, Part 4/09.90; gray</p>	 <p><b>Item No.: 216-262</b> Ferrule; Sleeve for 0.75 mm<sup>2</sup> / 18 AWG; un-insulated; electro-tin plated; electrolytic copper; gastight crimped; acc. to DIN 46228, Part 4/09.90; gray</p>
 <p><b>Item No.: 216-142</b> Ferrule; Sleeve for 0.75 mm<sup>2</sup> / 18 AWG; un-insulated; electro-tin plated; electrolytic copper; gastight crimped; acc. to DIN 46228, Part 1/08.92</p>	 <p><b>Item No.: 216-243</b> Ferrule; Sleeve for 1 mm<sup>2</sup> / AWG 18; insulated; electro-tin plated; electrolytic copper; gastight crimped; acc. to DIN 46228, Part 4/09.90; red</p>	 <p><b>Item No.: 216-263</b> Ferrule; Sleeve for 1 mm<sup>2</sup> / AWG 18; un-insulated; electro-tin plated; electrolytic copper; gastight crimped; acc. to DIN 46228, Part 4/09.90; red</p>	 <p><b>Item No.: 216-143</b> Ferrule; Sleeve for 1 mm<sup>2</sup> / AWG 18; un-insulated; electro-tin plated; electrolytic copper; gastight crimped; acc. to DIN 46228, Part 1/08.92</p>
 <p><b>Item No.: 216-244</b> Ferrule; Sleeve for 1.5 mm<sup>2</sup> / AWG 16; un-insulated; electro-tin plated; electrolytic copper; gastight crimped; acc. to DIN 46228, Part 4/09.90; black</p>	 <p><b>Item No.: 216-264</b> Ferrule; Sleeve for 1.5 mm<sup>2</sup> / AWG 16; un-insulated; electro-tin plated; electrolytic copper; gastight crimped; acc. to DIN 46228, Part 4/09.90; black</p>	 <p><b>Item No.: 216-284</b> Ferrule; Sleeve for 1.5 mm<sup>2</sup> / AWG 16; un-insulated; electro-tin plated; electrolytic copper; gastight crimped; acc. to DIN 46228, Part 4/09.90; black</p>	 <p><b>Item No.: 216-144</b> Ferrule; Sleeve for 1.5 mm<sup>2</sup> / AWG 16; un-insulated; electro-tin plated; electrolytic copper; gastight crimped; acc. to DIN 46228, Part 1/08.92; silver-colored</p>
 <p><b>Item No.: 216-246</b> Ferrule; Sleeve for 2.5 mm<sup>2</sup> / AWG 14; un-insulated; electro-tin plated; electrolytic copper; gastight crimped; acc. to DIN 46228, Part 4/09.90; blue</p>	 <p><b>Item No.: 216-266</b> Ferrule; Sleeve for 2.5 mm<sup>2</sup> / AWG 14; un-insulated; electro-tin plated; electrolytic copper; gastight crimped; acc. to DIN 46228, Part 4/09.90; blue</p>	 <p><b>Item No.: 216-286</b> Ferrule; Sleeve for 2.5 mm<sup>2</sup> / AWG 14; un-insulated; electro-tin plated; electrolytic copper; gastight crimped; acc. to DIN 46228, Part 4/09.90; blue</p>	 <p><b>Item No.: 216-106</b> Ferrule; Sleeve for 2.5 mm<sup>2</sup> / AWG 14; un-insulated; electro-tin plated; silver-colored</p>









**1.1.2 Jumper**

**1.1.2.1 Jumper**

 <p><b>Item No.: 745-180</b> Jumper; 10-way; silver-colored</p>	 <p><b>Item No.: 745-181</b> Jumper; 2-way; unplated; silver-colored</p>	 <p><b>Item No.: 745-182</b> Jumper; 2-way; unplated; silver-colored</p>	 <p><b>Item No.: 745-183</b> Jumper; 3-way; unplated; silver-colored</p>
 <p><b>Item No.: 745-184</b> Jumper; 4-way; unplated; silver-colored</p>	 <p><b>Item No.: 745-185</b> Jumper; 5-way; unplated; silver-colored</p>		

**1.1.3 Marking**

**1.1.3.1 Marker**

 <p><b>Item No.: 2009-145/000-006</b> Mini-WSB Inline; for Smart Printer; 1700 pieces on roll; stretchable 5 - 5.2 mm; plain; snap-on type; blue</p>	 <p><b>Item No.: 2009-145/000-007</b> Mini-WSB Inline; for Smart Printer; 1700 pieces on roll; stretchable 5 - 5.2 mm; plain; snap-on type; gray</p>	 <p><b>Item No.: 2009-145/000-023</b> Mini-WSB Inline; for Smart Printer; 1700 pieces on roll; stretchable 5 - 5.2 mm; plain; snap-on type; green</p>	 <p><b>Item No.: 2009-145/000-012</b> Mini-WSB Inline; for Smart Printer; 1700 pieces on roll; stretchable 5 - 5.2 mm; plain; snap-on type; orange</p>
 <p><b>Item No.: 2009-145/000-005</b> Mini-WSB Inline; for Smart Printer; 1700 pieces on roll; stretchable 5 - 5.2 mm; plain; snap-on type; red</p>	 <p><b>Item No.: 2009-145/000-024</b> Mini-WSB Inline; for Smart Printer; 1700 pieces on roll; stretchable 5 - 5.2 mm; plain; snap-on type; violet</p>	 <p><b>Item No.: 2009-145</b> Mini-WSB Inline; for Smart Printer; 1700 pieces on roll; stretchable 5 - 5.2 mm; plain; snap-on type; white</p>	 <p><b>Item No.: 2009-145/000-002</b> Mini-WSB Inline; for Smart Printer; 1700 pieces on roll; stretchable 5 - 5.2 mm; plain; snap-on type; yellow</p>

1.1.3.1 Marker



**Item No.: 248-501/000-006**  
Mini-WSB marking card; as card; not stretchable; plain; snap-on type; blue



**Item No.: 248-501/000-007**  
Mini-WSB marking card; as card; not stretchable; plain; snap-on type; gray



**Item No.: 248-501/000-023**  
Mini-WSB marking card; as card; not stretchable; plain; snap-on type; green



**Item No.: 248-501/000-017**  
Mini-WSB marking card; as card; not stretchable; plain; snap-on type; light green



**Item No.: 248-501/000-012**  
Mini-WSB marking card; as card; not stretchable; plain; snap-on type; orange



**Item No.: 248-501/000-005**  
Mini-WSB marking card; as card; not stretchable; plain; snap-on type; red



**Item No.: 248-501/000-024**  
Mini-WSB marking card; as card; not stretchable; plain; snap-on type; violet



**Item No.: 248-501**  
Mini-WSB marking card; as card; not stretchable; plain; snap-on type; white



**Item No.: 248-501/000-002**  
Mini-WSB marking card; as card; not stretchable; plain; snap-on type; yellow



**Item No.: 793-5501/000-006**  
WMB marking card; as card; for terminal block width 5 - 17.5 mm; stretchable 5 - 5.2 mm; plain; snap-on type; blue



**Item No.: 793-5501/000-007**  
WMB marking card; as card; for terminal block width 5 - 17.5 mm; stretchable 5 - 5.2 mm; plain; snap-on type; gray



**Item No.: 793-5501/000-023**  
WMB marking card; as card; for terminal block width 5 - 17.5 mm; stretchable 5 - 5.2 mm; plain; snap-on type; green



**Item No.: 793-5501/000-017**  
WMB marking card; as card; for terminal block width 5 - 17.5 mm; stretchable 5 - 5.2 mm; plain; snap-on type; light green



**Item No.: 793-5501/000-012**  
WMB marking card; as card; for terminal block width 5 - 17.5 mm; stretchable 5 - 5.2 mm; plain; snap-on type; orange



**Item No.: 793-5501/000-005**  
WMB marking card; as card; for terminal block width 5 - 17.5 mm; stretchable 5 - 5.2 mm; plain; snap-on type; red



**Item No.: 793-5501/000-024**  
WMB marking card; as card; for terminal block width 5 - 17.5 mm; stretchable 5 - 5.2 mm; plain; snap-on type; violet



**Item No.: 793-5501**  
WMB marking card; as card; for terminal block width 5 - 17.5 mm; stretchable 5 - 5.2 mm; plain; snap-on type; white



**Item No.: 793-5501/000-002**  
WMB marking card; as card; for terminal block width 5 - 17.5 mm; stretchable 5 - 5.2 mm; plain; snap-on type; yellow



**Item No.: 793-501/000-006**  
WMB marking card; as card; not stretchable; plain; snap-on type; blue



**Item No.: 793-501/000-007**  
WMB marking card; as card; not stretchable; plain; snap-on type; gray



**Item No.: 793-501/000-023**  
WMB marking card; as card; not stretchable; plain; snap-on type; green



**Item No.: 793-501/000-017**  
WMB marking card; as card; not stretchable; plain; snap-on type; light green



**Item No.: 793-501/000-012**  
WMB marking card; as card; not stretchable; plain; snap-on type; orange



**Item No.: 793-501/000-005**  
WMB marking card; as card; not stretchable; plain; snap-on type; red



**Item No.: 793-501/000-024**  
WMB marking card; as card; not stretchable; plain; snap-on type; violet



**Item No.: 793-501**  
WMB marking card; as card; not stretchable; plain; snap-on type; white



**Item No.: 793-501/000-002**  
WMB marking card; as card; not stretchable; plain; snap-on type; yellow



**Item No.: 2009-115/000-006**  
WMB-Inline; for Smart Printer; 1500 pieces on roll; stretchable 5 - 5.2 mm; plain; snap-on type; blue



**Item No.: 2009-115/000-007**  
WMB-Inline; for Smart Printer; 1500 pieces on roll; stretchable 5 - 5.2 mm; plain; snap-on type; gray



**Item No.: 2009-115/000-023**  
WMB-Inline; for Smart Printer; 1500 pieces on roll; stretchable 5 - 5.2 mm; plain; snap-on type; green



**Item No.: 2009-115/000-017**  
WMB-Inline; for Smart Printer; 1500 pieces on roll; stretchable 5 - 5.2 mm; plain; snap-on type; light green



**Item No.: 2009-115/000-012**  
WMB-Inline; for Smart Printer; 1500 pieces on roll; stretchable 5 - 5.2 mm; plain; snap-on type; orange



**Item No.: 2009-115/000-024**  
WMB-Inline; for Smart Printer; 1500 pieces on roll; stretchable 5 - 5.2 mm; plain; snap-on type; violet



**Item No.: 2009-115**  
WMB-Inline; for Smart Printer; 1500 pieces on roll; stretchable 5 - 5.2 mm; plain; snap-on type; white



**Item No.: 2009-115/000-002**  
WMB-Inline; for Smart Printer; 1500 pieces on roll; stretchable 5 - 5.2 mm; plain; snap-on type; yellow

1.1.4 Test and measurement

1.1.4.1 Testing accessories



**Item No.: 210-136**  
Test plug; 2 mm Ø; with 500 mm cable; red

## 1.1.5 Tool

### 1.1.5.1 Operating tool



**Item No.: 210-658**

Operating tool; Blade: 3.5 x 0.5 mm; with a partially insulated shaft; angled; short; multicoloured



**Item No.: 210-720**

Operating tool; Blade: 3.5 x 0.5 mm; with a partially insulated shaft; multicoloured



**Item No.: 210-657**

Operating tool; Blade: 3.5 x 0.5 mm; with a partially insulated shaft; short; multicoloured

## Installation Notes

### Conductor termination



Inserting/removing a conductor via 5.5 mm screwdriver – 745 Series, 16 mm<sup>2</sup>.

## Marking



Marking via Mini-WSB and WMB markers or factory direct marking – 745 Series.

## Testing



Testing with test plug – 745 Series.

## Commoning



Inserting a comb-style jumper bar.



To insert a comb-style jumper bar, push it down using a screwdriver until it hits the backstop – 745 Series.



To remove the jumper bar, lift it up using a screwdriver – 745 Series.