



Omschrijving	RCCB MET OVERSTROOMBEVEILIGING
Code	MDC 100
Aant. polen	3P
Aant. modules	3
Nominale stroom	32 A
Nominale aardlekstroom	30 mA
Type	A
Curve	C
Nominale spanning (IEC/EN 61009-1, 61009-2-1)	230/240 V
Energiebeperkingsklasse	3

Standaard	IEC/EN 61009-1, IEC/EN 61009-2-1	Nominale frequentie (Hz)	50/60 Hz
Breekcapaciteit IEC/EN 61009-1 230V (Icn)	10000 A	Breekcapaciteit IEC/EN 61009-1 400V (Icn)	10000 A
Breekcapaciteit IEC/EN 61009-1 (Ics)	0,75 x Icn	Breekcapaciteit IEC/EN 60947-2 230V (Icu)	15 kA
Breekcapaciteit IEC/EN 60947-2 (Ics)	50% Icu	Isolatievoltage (Ui)	500 V
Immunitie niveau (8/20 µs)	250 A	Nominale impuls schokbestendigheidsspanning (Uimp)	4 kV
Overspannings categorie	III	Elektrische duurbestendigheid	10.000
Mechanische duurbestendigheid	20.000	Sectie rigide kabel	<=1x35 - <=2x16 - <=1x16+2x10 mm²
Sectie flexibele kabel	<=1x35 - <=2x16 - <=1x16+2x10 mm²	Dubbele verbinding	JA (alleen stroomafwaarts)
Nominale aandraaikoppel	2 Nm	Bedrijfstemperatuur	-25 +60° C (derating van In met T>30° C)
Opslagtemperatuur	-40 +70 °C	Comptabiliteit aanvullingen	Ja
Montage positie	Elke		

DIMENSIONAL



WIRING DIAGRAM

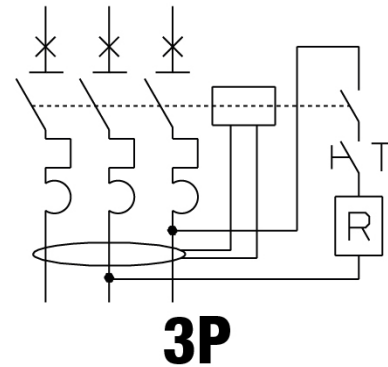

STANDARDS/APPROVALS

