

## Data Sheet | Item Number: 2002-1611/1000-541

2-conductor fuse terminal block; with pivoting fuse holder; with end plate; for 5 x 20 mm miniature metric fuse; with blown fuse indication by LED; 12 - 30 V; for DIN-rail 35 x 15 and 35 x 7.5; 2.5 mm<sup>2</sup>; Push-in CAGE CLAMP®; 2,50 mm<sup>2</sup>; gray

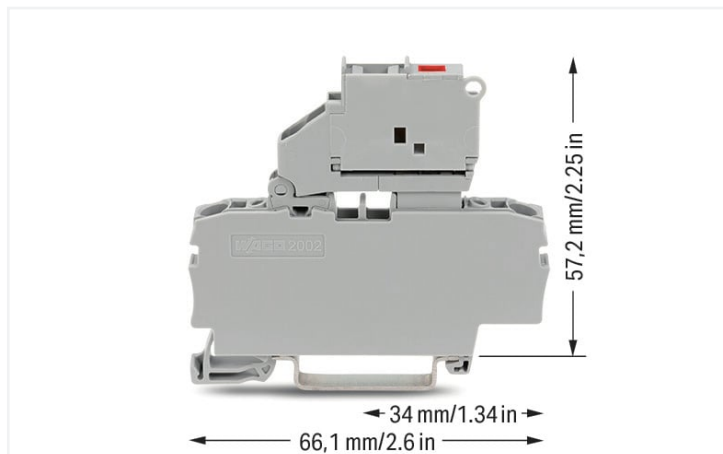

<https://www.wago.com/2002-1611/1000-541>



Color: ■ gray

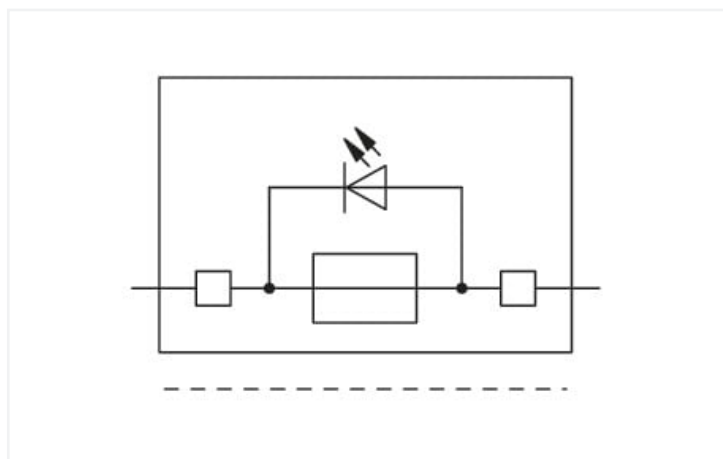

### Electrical data

Ratings per	IEC/EN 60947-7-3		
Overtoltage category	III	III	II
Pollution degree	3	2	2
Nominal voltage	250 V	-	-
Rated surge voltage	6 kV	-	-
Rated current	6.3 A	-	-

Approvals per	UL 1059		
Use group	B	C	D
Rated voltage	30 V	30 V	30 V
Rated current	10 A	10 A	10 A

Ratings per	IEC/EN 60947-7-3		
Overtoltage category	III	III	II
Pollution degree	3	2	2
Nominal voltage	30 V	-	-
Rated surge voltage	0.8 kV	-	-
Rated current	-	-	-

Approvals per	CSA 22.2 No 158		
Use group	B	C	D
Rated voltage	250 V	250 V	-
Rated current	6.3 A	6.3 A	-

### Ex information

Reference hazardous areas	See "Downloads – Documentation – Additional Information: Technical Section; Technical Explanations"
Ratings per	ATEX: KIWA 17 ATEX 0030 U / IECEx: KIWA 17.0014U (Ex ec IIC Gc)
Rated voltage EN (Ex e II)	24 V
Rated current (Ex e II)	6.3 A

### General information

Fuse receptacle	pivoting
Fuse type	Cylindrical fuse; 5 x 20 mm

### Connection data

Connection points	2
Total number of potentials	1
Number of levels	1
Number of jumper slots	2

### Connection 1

Connection technology	Push-in CAGE CLAMP®
Actuation type	Operating tool
Connectable conductor materials	Copper
Nominal cross-section	2.5 mm <sup>2</sup>
Solid conductor	0.25 ... 4 mm <sup>2</sup> / 22 ... 12 AWG
Solid conductor; push-in termination	0.75 ... 4 mm <sup>2</sup> / 18 ... 12 AWG
Fine-stranded conductor	0.25 ... 4 mm <sup>2</sup> / 22 ... 12 AWG
Fine-stranded conductor; with insulated ferrule	0.25 ... 2.5 mm <sup>2</sup> / 22 ... 14 AWG
Fine-stranded conductor; with ferrule; push-in termination	1 ... 2.5 mm <sup>2</sup> / 18 ... 14 AWG
Note (conductor cross-section)	Depending on the conductor characteristic, a conductor with a smaller cross-section can also be inserted via push-in termination.
Strip length	10 ... 12 mm / 0.39 ... 0.47 inches
Wiring direction	Front-entry wiring

### Physical data

Width	6.2 mm / 0.244 inches
Height	66.1 mm / 2.602 inches
Depth from upper-edge of DIN-rail	57.2 mm / 2.252 inches

### Mechanical data

Mounting type	DIN-35 rail
Marking level	Center/side marking

### Material data

Note (material data)	<a href="https://www.wago.com/us/material-specifications">Information on material specifications can be found here</a>
Color	gray
Material group	I
Insulation material	Polyamide (PA66)
Flammability class per UL94	V0
Fire load	0.294 MJ
Weight	13.5 g

### Environmental requirements

Ambient temperature (operation)	-35 ... +70 °C
Processing temperature	-35 ... +70 °C
Continuous operating temperature	-35 ... +70 °C

### Commercial data

Product Group	22 (TOPJOB S)
eCl@ss 10.0	27-14-11-16
eCl@ss 9.0	27-14-11-16
ETIM 8.0	EC000899
ETIM 7.0	EC000899
PU (SPU)	50 pcs
Packaging type	Box
Country of origin	CN
GTIN	4066966335804
Customs tariff number	85369095000

### Environmental Product Compliance

CAS-No.	7439-92-1 7440-43-9
REACH Candidate List Substance	Cadmium Lead
RoHS Compliance Status	Compliant,With Exemption
RoHS Exemption	7(a) 7(c)-I
SCIP notification number (Austria)	a54f1676-ddf2-4f54-b9bd-f653d6986def
SCIP notification number (Belgium)	e0161091-efa6-4165-8e03-8f14872dd495
SCIP notification number (Bulgaria)	00dbba31-ac7c-4bef-9c68-f33ecd0f3e9b
SCIP notification number (Czech Republic)	6eab5509-57ed-4a56-9ce0-711cbd687d07
SCIP notification number (Denmark)	c84188b4-b8cd-496e-bab7-f80edfcd86b2
SCIP notification number (Finland)	c315bf1a-a42c-489f-86d0-1c0f29190264
SCIP notification number (France)	136746eb-42aa-44e7-869f-a928dd5c60f8
SCIP notification number (Germany)	4674dd13-a982-47cf-b8ea-60b9bb4cc2e2
SCIP notification number (Hungary)	a278a177-ce31-4429-a3cf-791e4138a142
SCIP notification number (Italy)	f20875d1-c1ea-4503-b6c6-ccdb9a44241a
SCIP notification number (Netherlands)	1eb7922d-6d31-4d04-9c57-12561d36c3d7
SCIP notification number (Poland)	0a8c3f45-4557-43d2-8205-9d8a88f5a474
SCIP notification number (Romania)	cc48fb51-f1b7-4e0a-8e47-4e7de466280b
SCIP notification number (Sweden)	108ad70b-a647-4a24-828f-9185ad23bce9

### Approvals / Certificates

#### General approvals



Approval	Standard	Certificate Name
CCA DEKRA Certification B.V.	EN 60947	NTR NL 7941
KEMA/KEUR DEKRA Certification B.V.	EN 60947	71-124163
UL Underwriters Laboratories Inc.	UL 1059	E45172

#### Declarations of conformity and manufacturer's declarations



Approval	Standard	Certificate Name
ATEX-Attestation of Con- formity WAGO GmbH & Co. KG	-	-
EU-Declaration of Confor- mity WAGO GmbH & Co. KG	-	-
Railway WAGO GmbH & Co. KG	-	Railway Ready

Declarations of conformity and manufacturer's declarations	
UK-Declaration of Conformity	-
WAGO GmbH & Co. KG	-

Approvals for marine applications



Approval	Standard	Certificate Name
ABS American Bureau of Shipping	EN 60947	20-HG1941090-PDA
DNV GL Det Norske Veritas, Germanischer Lloyd	-	TAE00001V2

Approvals for hazardous areas



Approval	Standard	Certificate Name
AEx Underwriters Laboratories Inc.	UL 60079	E185892 (AEx eb IIC resp. Ex eb IIC)
ATEX KIWA Netherlands B.V.	EN 60079	KIWA 17ATEX0030 U
CCC CNEX	GB/T 3836.3	2020312313000180 (Ex ec IIC Gc)
IECEx KIWA Netherlands B.V.	EN 60079	IECEx KIWA 17.0014U (Ex ec IIC Gc)

Downloads

Environmental Product Compliance

Compliance Search	
Environmental Product Compliance	<a href="#">↓</a>
2002-1611/1000-541	

Documentation

Additional Information		
Technical Section	pdf 2240.62 KB	<a href="#">↓</a>

Bid Text			
2002-1611/1000-541	29.04.2019	xml 4.29 KB	<a href="#">↓</a>
2002-1611/1000-541	23.04.2019	docx 15.45 KB	<a href="#">↓</a>

CAD/CAE-Data

CAD data	
2D/3D Models	<a href="#">↓</a>
2002-1611/1000-541	

CAE data	
EPLAN Data Portal	<a href="#">↓</a>
2002-1611/1000-541	
WSCAD Universe	<a href="#">↓</a>
2002-1611/1000-541	
ZUKEN Portal	<a href="#">↓</a>
2002-1611/1000-541	

## 1 Compatible Products

### 1.1 Required Accessories

#### 1.1.1 End plate

##### 1.1.1.1 End plate



**Item No.: 209-191**  
 Separator for Ex e/Ex i applications; 3 mm thick; 120 mm wide; orange

### 1.2 Optional Accessories

#### 1.2.1 DIN-rail

##### 1.2.1.1 Mounting accessories



**Item No.: 210-196**  
 Aluminum carrier rail; 35 x 8.2 mm; 1.6 mm thick; 2 m long; unslotted; similar to EN 60715; silver-colored



**Item No.: 210-198**  
 Copper carrier rail; 35 x 15 mm; 2.3 mm thick; 2 m long; unslotted; according to EN 60715; copper-colored



**Item No.: 210-508**  
 Steel carrier rail; 35 x 15 mm; 1.5 mm thick; 2 m long; slotted; galvanized; similar to EN 60715; silver-colored



**Item No.: 210-197**  
 Steel carrier rail; 35 x 15 mm; 1.5 mm thick; 2 m long; slotted; similar to EN 60715; silver-colored



**Item No.: 210-506**  
 Steel carrier rail; 35 x 15 mm; 1.5 mm thick; 2 m long; unslotted; galvanized; similar to EN 60715; silver-colored



**Item No.: 210-114**  
 Steel carrier rail; 35 x 15 mm; 1.5 mm thick; 2 m long; unslotted; similar to EN 60715; silver-colored



**Item No.: 210-118**  
 Steel carrier rail; 35 x 15 mm; 2.3 mm thick; 2 m long; unslotted; according to EN 60715; silver-colored



**Item No.: 210-115**  
 Steel carrier rail; 35 x 7.5 mm; 1 mm thick; 2 m long; slotted; according to EN 60715; "Hole width 18 mm; silver-colored



**Item No.: 210-112**  
 Steel carrier rail; 35 x 7.5 mm; 1 mm thick; 2 m long; slotted; according to EN 60715; "Hole width 25 mm; silver-colored



**Item No.: 210-504**  
 Steel carrier rail; 35 x 7.5 mm; 1 mm thick; 2 m long; slotted; galvanized; according to EN 60715; silver-colored



**Item No.: 210-113**  
 Steel carrier rail; 35 x 7.5 mm; 1 mm thick; 2 m long; unslotted; according to EN 60715; silver-colored



**Item No.: 210-505**  
 Steel carrier rail; 35 x 7.5 mm; 1 mm thick; 2 m long; unslotted; galvanized; according to EN 60715; silver-colored

#### 1.2.2 End plate

##### 1.2.2.1 End plate



**Item No.: 2002-991**  
 End plate for fuse terminal blocks; 2 mm thick; gray



**Item No.: 2002-992**  
 End plate for fuse terminal blocks; 2 mm thick; orange

#### 1.2.3 Ferrule

##### 1.2.3.1 Ferrule



**Item No.: 216-241**  
 Ferrule; Sleeve for 0.5 mm<sup>2</sup> / 20 AWG; insulated; electro-tin plated; electrolytic copper; gastight crimped; acc. to DIN 46228, Part 4/09.90; white



**Item No.: 216-242**  
 Ferrule; Sleeve for 0.75 mm<sup>2</sup> / 18 AWG; insulated; electro-tin plated; electrolytic copper; gastight crimped; acc. to DIN 46228, Part 4/09.90; gray



**Item No.: 216-262**  
 Ferrule; Sleeve for 0.75 mm<sup>2</sup> / 18 AWG; insulated; electro-tin plated; electrolytic copper; gastight crimped; acc. to DIN 46228, Part 4/09.90; gray



**Item No.: 216-243**  
 Ferrule; Sleeve for 1 mm<sup>2</sup> / AWG 18; insulated; electro-tin plated; electrolytic copper; gastight crimped; acc. to DIN 46228, Part 4/09.90; red

### 1.2.3.1 Ferrule



**Item No.: 216-263**

Ferrule; Sleeve for 1 mm<sup>2</sup> / AWG 18; insulated; electro-tin plated; electrolytic copper; gastight crimped; acc. to DIN 46228, Part 4/09.90; red

**Item No.: 216-244**

Ferrule; Sleeve for 1.5 mm<sup>2</sup> / AWG 16; insulated; electro-tin plated; electrolytic copper; gastight crimped; acc. to DIN 46228, Part 4/09.90; black

**Item No.: 216-264**

Ferrule; Sleeve for 1.5 mm<sup>2</sup> / AWG 16; insulated; electro-tin plated; electrolytic copper; gastight crimped; acc. to DIN 46228, Part 4/09.90; black

**Item No.: 216-246**

Ferrule; Sleeve for 2.5 mm<sup>2</sup> / AWG 14; insulated; electro-tin plated; electrolytic copper; gastight crimped; acc. to DIN 46228, Part 4/09.90; blue



**Item No.: 216-266**

Ferrule; Sleeve for 2.5 mm<sup>2</sup> / AWG 14; insulated; electro-tin plated; electrolytic copper; gastight crimped; acc. to DIN 46228, Part 4/09.90; blue

### 1.2.4 Installation

#### 1.2.4.1 Cover



**Item No.: 709-156**

Cover; Type 3; suitable for cover carrier, type 3; 1 m long; transparent

#### 1.2.4.2 Cover carrier



**Item No.: 709-169**

Cover carrier; Type 3; incl. fixing/retaining screws and knurled nut; suitable for 279 to 282 and 880 Series rail-mounted terminal blocks; suitable for 264 Series miniature rail-mounted terminal blocks; suitable for 270 Series sensor and actuator terminal blocks; gray

### 1.2.5 Insulation stop

#### 1.2.5.1 Insulation stop



**Item No.: 2002-171**

Insulation stop; 0.25 - 0.5 mm<sup>2</sup>; 5 pieces/strip; light gray



**Item No.: 2002-172**

Insulation stop; 0.75 - 1 mm<sup>2</sup>; 5 pieces/strip; dark gray

### 1.2.6 Jumper

#### 1.2.6.1 Jumper



**Item No.: 2004-406/020-000**

Delta jumper; insulated; light gray



**Item No.: 2004-410**

Jumper; 10-way; insulated; light gray



**Item No.: 2004-402**

Jumper; 2-way; insulated; light gray



**Item No.: 2004-403**

Jumper; 3-way; insulated; light gray



**Item No.: 2004-404**

Jumper; 4-way; insulated; light gray



**Item No.: 2004-405**

Jumper; 5-way; insulated; light gray



**Item No.: 2004-406**

Jumper; 6-way; insulated; light gray



**Item No.: 2004-407**

Jumper; 7-way; insulated; light gray

1.2.6.1 Jumper

 <b>Item No.: 2004-408</b> Jumper; 8-way; insulated; light gray	 <b>Item No.: 2004-409</b> Jumper; 9-way; insulated; light gray	 <b>Item No.: 2004-440</b> Jumper; from 1 to 10; insulated; light gray	 <b>Item No.: 2004-433</b> Jumper; from 1 to 3; insulated; light gray
 <b>Item No.: 2004-434</b> Jumper; from 1 to 4; insulated; light gray	 <b>Item No.: 2004-435</b> Jumper; from 1 to 5; insulated; light gray	 <b>Item No.: 2004-436</b> Jumper; from 1 to 6; insulated; light gray	 <b>Item No.: 2004-437</b> Jumper; from 1 to 7; insulated; light gray
 <b>Item No.: 2004-438</b> Jumper; from 1 to 8; insulated; light gray	 <b>Item No.: 2004-439</b> Jumper; from 1 to 9; insulated; light gray	 <b>Item No.: 2004-405/011-000</b> Star point jumper; 3-way; insulated; light gray	 <b>Item No.: 210-103</b> Wire commoning chain; insulated; black gray
			
<b>Item No.: 210-123</b> Wire commoning chain; insulated; blue			





















1.2.7 Locking system

1.2.7.1 Locking system

 <b>Item No.: 210-254</b> Interlocking link; mechanically locks multiple links; 1 m long; transparent
--

1.2.8 Marking

1.2.8.1 Marker

 <b>Item No.: 2009-145/000-006</b> Mini-WSB Inline; for Smart Printer; 1700 pieces on roll; stretchable 5 - 5.2 mm; plain; snap-on type; blue	 <b>Item No.: 2009-145/000-007</b> Mini-WSB Inline; for Smart Printer; 1700 pieces on roll; stretchable 5 - 5.2 mm; plain; snap-on type; gray	 <b>Item No.: 2009-145/000-023</b> Mini-WSB Inline; for Smart Printer; 1700 pieces on roll; stretchable 5 - 5.2 mm; plain; snap-on type; green	 <b>Item No.: 2009-145/000-012</b> Mini-WSB Inline; for Smart Printer; 1700 pieces on roll; stretchable 5 - 5.2 mm; plain; snap-on type; orange
 <b>Item No.: 2009-145/000-005</b> Mini-WSB Inline; for Smart Printer; 1700 pieces on roll; stretchable 5 - 5.2 mm; plain; snap-on type; red	 <b>Item No.: 2009-145/000-024</b> Mini-WSB Inline; for Smart Printer; 1700 pieces on roll; stretchable 5 - 5.2 mm; plain; snap-on type; violet	 <b>Item No.: 2009-145</b> Mini-WSB Inline; for Smart Printer; 1700 pieces on roll; stretchable 5 - 5.2 mm; plain; snap-on type; white	 <b>Item No.: 2009-145/000-002</b> Mini-WSB Inline; for Smart Printer; 1700 pieces on roll; stretchable 5 - 5.2 mm; plain; snap-on type; yellow
 <b>Item No.: 248-501/000-006</b> Mini-WSB marking card; as card; not stretchable; plain; snap-on type; blue	 <b>Item No.: 248-501/000-007</b> Mini-WSB marking card; as card; not stretchable; plain; snap-on type; gray	 <b>Item No.: 248-501/000-023</b> Mini-WSB marking card; as card; not stretchable; plain; snap-on type; green	 <b>Item No.: 248-501/000-017</b> Mini-WSB marking card; as card; not stretchable; plain; snap-on type; light green
 <b>Item No.: 248-501/000-012</b> Mini-WSB marking card; as card; not stretchable; plain; snap-on type; orange	 <b>Item No.: 248-501/000-005</b> Mini-WSB marking card; as card; not stretchable; plain; snap-on type; red	 <b>Item No.: 248-501/000-024</b> Mini-WSB marking card; as card; not stretchable; plain; snap-on type; violet	 <b>Item No.: 248-501</b> Mini-WSB marking card; as card; not stretchable; plain; snap-on type; white
 <b>Item No.: 248-501/000-002</b> Mini-WSB marking card; as card; not stretchable; plain; snap-on type; yellow	 <b>Item No.: 793-5501/000-006</b> WMB marking card; as card; for terminal block width 5 - 17.5 mm; stretchable 5 - 5.2 mm; plain; snap-on type; blue	 <b>Item No.: 793-5501/000-014</b> WMB marking card; as card; for terminal block width 5 - 17.5 mm; stretchable 5 - 5.2 mm; plain; snap-on type; brown	 <b>Item No.: 793-5501/000-007</b> WMB marking card; as card; for terminal block width 5 - 17.5 mm; stretchable 5 - 5.2 mm; plain; snap-on type; gray

1.2.8.1 Marker



**Item No.: 793-5501/000-023**

WMB marking card; as card; for terminal block width 5 - 17.5 mm; stretchable 5 - 5.2 mm; plain; snap-on type; green



**Item No.: 793-5501/000-017**

WMB marking card; as card; for terminal block width 5 - 17.5 mm; stretchable 5 - 5.2 mm; plain; snap-on type; light green



**Item No.: 793-5501/000-012**

WMB marking card; as card; for terminal block width 5 - 17.5 mm; stretchable 5 - 5.2 mm; plain; snap-on type; orange



**Item No.: 793-5501/000-005**

WMB marking card; as card; for terminal block width 5 - 17.5 mm; stretchable 5 - 5.2 mm; plain; snap-on type; red



**Item No.: 793-5501/000-024**

WMB marking card; as card; for terminal block width 5 - 17.5 mm; stretchable 5 - 5.2 mm; plain; snap-on type; violet



**Item No.: 793-5501**

WMB marking card; as card; for terminal block width 5 - 17.5 mm; stretchable 5 - 5.2 mm; plain; snap-on type; white



**Item No.: 793-5501/000-002**

WMB marking card; as card; for terminal block width 5 - 17.5 mm; stretchable 5 - 5.2 mm; plain; snap-on type; yellow



**Item No.: 2009-115/000-006**

WMB-Inline; for Smart Printer; 1500 pieces on roll; stretchable 5 - 5.2 mm; plain; snap-on type; blue



**Item No.: 2009-115/000-007**

WMB-Inline; for Smart Printer; 1500 pieces on roll; stretchable 5 - 5.2 mm; plain; snap-on type; gray



**Item No.: 2009-115/000-023**

WMB-Inline; for Smart Printer; 1500 pieces on roll; stretchable 5 - 5.2 mm; plain; snap-on type; green



**Item No.: 2009-115/000-017**

WMB-Inline; for Smart Printer; 1500 pieces on roll; stretchable 5 - 5.2 mm; plain; snap-on type; light green



**Item No.: 2009-115/000-012**

WMB-Inline; for Smart Printer; 1500 pieces on roll; stretchable 5 - 5.2 mm; plain; snap-on type; orange



**Item No.: 2009-115/000-005**

WMB-Inline; for Smart Printer; 1500 pieces on roll; stretchable 5 - 5.2 mm; plain; snap-on type; red



**Item No.: 2009-115/000-024**

WMB-Inline; for Smart Printer; 1500 pieces on roll; stretchable 5 - 5.2 mm; plain; snap-on type; violet



**Item No.: 2009-115**

WMB-Inline; for Smart Printer; 1500 pieces on roll; stretchable 5 - 5.2 mm; plain; snap-on type; white



**Item No.: 2009-115/000-002**

WMB-Inline; for Smart Printer; 1500 pieces on roll; stretchable 5 - 5.2 mm; plain; snap-on type; yellow

1.2.8.2 Marking strip



**Item No.: 2009-110**

Marking strips; for Smart Printer; on reel; not stretchable; plain; snap-on type; white

1.2.9 Protective warning marker

1.2.9.1 Cover



**Item No.: 2002-115**

Protective warning marker; for 5 terminal blocks; with high-voltage symbol, black; yellow

1.2.10 Screwless end stop

1.2.10.1 Mounting accessories



**Item No.: 249-117**

Screwless end stop; 10 mm wide; for DIN-rail 35 x 15 and 35 x 7.5; gray



**Item No.: 249-116**

Screwless end stop; 6 mm wide; for DIN-rail 35 x 15 and 35 x 7.5; gray



## 1.2.11 Test and measurement

### 1.2.11.1 Testing accessories



**Item No.: 210-136**

Test plug; 2 mm Ø; with 500 mm cable; red

## 1.2.12 Tool

### 1.2.12.1 Operating tool



**Item No.: 210-658**

Operating tool; Blade: 3.5 x 0.5 mm; with a partially insulated shaft; angled; short; multicoloured



**Item No.: 210-720**

Operating tool; Blade: 3.5 x 0.5 mm; with a partially insulated shaft; multicoloured

## Installation Notes

### Conductor termination



**All conductor types at a glance**

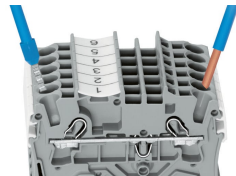

Push-in termination of solid and ferruled conductors

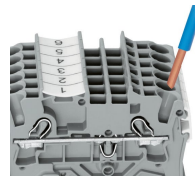

**Inserting a conductor via push-in termination:**  
Solid conductors with cross-sections from either one size above, or up to two sizes below, the rated cross-section can be simply pushed in – no tools needed.

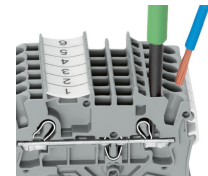

**Inserting a conductor via operating tool:**  
Connecting fine-stranded conductors without ferrules, or small cross-sectional conductors that cannot be pushed in, is performed similarly to the original CAGE CLAMP® – just use an operating tool.  
**Advantage:**  
To open the clamp, the operating tool is inserted vertically. The conductor entry is less than 15 degrees for easier wiring.

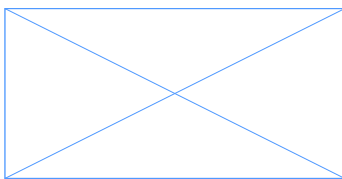

Conductor termination – insulation stop

### Commoning

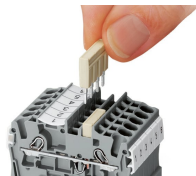

Insert push-in type jumper bar and push down until it hits backstop.

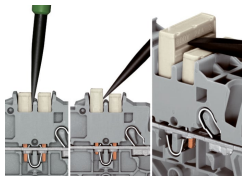

**Removing a push-in type jumper bar:**  
Insert the operating tool between the jumper and partition wall of the dual jumper slots, then lift up the jumper. Place the operating tool in the center of jumpers for up to five contacts (see above), or alternately on both sides for jumpers with more than five contacts.



Fuse terminal blocks with a width of 6.2 mm/0.244 in can be assembled adjacently. If there is no adjacent fuse terminal block at the end of the assembly, an end plate must be used.

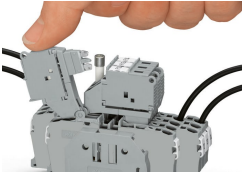

**Fused Disconnect Terminal Block with a Pivoting Fuse Holder**  
Pivot the fuse holder into the locked open position.



**Fused disconnect terminal block with a pivoting fuse holder**  
Fuse replacement

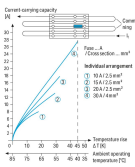

**Application Notes on Terminal Blocks for Glass Cartridge Fuses**  
Diagram: "Individual Arrangement"

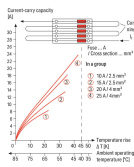

**Application Notes on Terminal Blocks for Glass Cartridge Fuses**  
Diagram: "Block Arrangement"

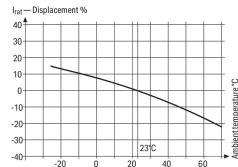

**Application Notes on Terminal Blocks for Glass Cartridge Fuses**

Nominal current ratings for fuse cartridges are defined differently in international standards. This is why the recommended continuous current-carrying capacity of the fuses is a max. 80% of their nominal current according to DIN 72581/Part 3 (for a surrounding air temperature of 23°C).  
Selecting the correct fuse cartridge is important for product safety within applications, as well as for fuse cartridge service life and reliability. Fuse cartridges will only operate perfectly as protection components (break-off point) if they are properly selected and used as intended (i.e., according to the state of the technology and valid specifications, as well as data sheet characteristics), according to basic safety requirements (i.e., persons, animals and property must be protected against hazards).

Concerning product safety, fuse cartridges must generally be tested under both normal and faulty operating conditions within your application.

Information from the mini-automotive, blade-type fuse manufacturers

Operating Temp. °C	%	$I_f$
-25	14	0.877
-15	12	0.885
-5	11	0.893
5	10	0.901
15	9	0.910
25	8	0.919
35	7	0.928
45	6	0.937
55	5	0.946
65	4	0.955
75	3	0.964
85	2	0.973
95	1	0.982
105	0	0.991
115	-1	1.000
125	-2	1.009
135	-3	1.018
145	-4	1.027
155	-5	1.036
165	-6	1.045
175	-7	1.054
185	-8	1.063
195	-9	1.072
205	-10	1.081
215	-11	1.090
225	-12	1.099
235	-13	1.108
245	-14	1.117
255	-15	1.126
265	-16	1.135
275	-17	1.144
285	-18	1.153
295	-19	1.162
305	-20	1.171
315	-21	1.180
325	-22	1.189

**Marking**

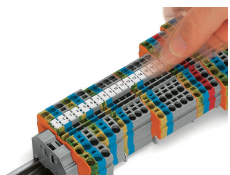

Snapping WMB Inline markers into marker slots.

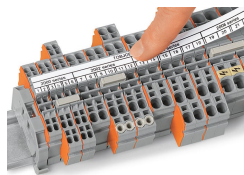

Subject to changes. Please also observe the further product documentation!

---

Current addresses can be found at: [www.wago.com](http://www.wago.com)