











Spout 165 x 35 x 11 x 205 mm, 5,68l/min. - Brushed Champagne (22kt Gold)

SPARE PARTS

90 28 22 153 01 Product version from 4/1/2025



	Brushed Champagne (22kt Gold)	90 28 22 153 01-46
	Chrome	90 28 22 153 01-00
	Brushed Platinum	90 28 22 153 01-06
	Platinum	90 28 22 153 01-08
	Dark Chrome	90 28 22 153 01-19
	Brushed Light Gold (PVD)	90 28 22 153 01-27
	Brushed Durabrass (23kt Gold)	90 28 22 153 01-28
	Brushed Dark Brass (PVD)	90 28 22 153 01-39
	Brushed Bronze (PVD)	90 28 22 153 01-42
	Champagne (22kt Gold)	90 28 22 153 01-47
	Brushed Dark Platinum	90 28 22 153 01-99



Spout 165 x 35 x 11 x 205 mm, 5,68l/min. - Brushed Champagne (22kt Gold)

SPARE PARTS

90 28 22 153 01 Product version from 4/1/2025



Spout 165 x 35 x 11 x 205 mm, 5,68l/min. - Brushed Champagne (22kt Gold)

SPARE PARTS

90 28 22 153 01 Product version from 4/1/2025

90 28 22 153 01 Product version from 4/1/2025

Parts for other finishes can be found here: [Chrome](#)

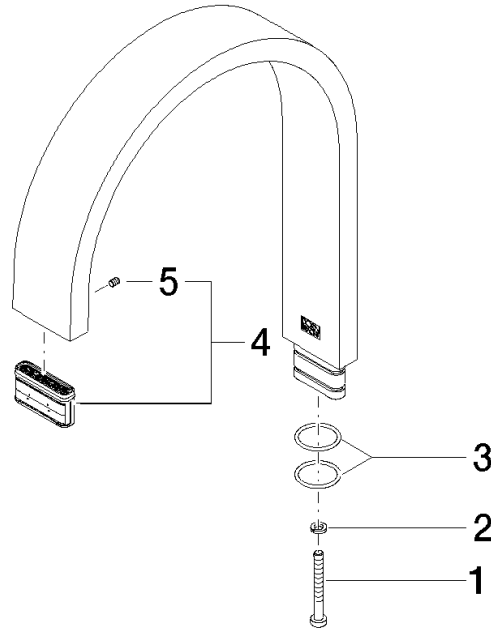

Spare parts list

No.	Item Number	Name	Quantity used	Delivery time
3	09 14 10 096 90	O-Ring EPDM 70 17,0 x 1,5 mm -	2.00	14
2	90 30 11 029 00 90	Connection Spring lock washer Ø 4 -	1.00	14
1	09 30 30 097 90	Mounting Cylinder head screw with hexagon socket Low profile M4 x 35 mm -	1.00	14
5	09 31 11 064 90	Mounting Threaded pin with hexagon socket with chamfered end M3 x 4 mm -	1.00	14
4	90 29 03 109 00 90	Aerator insert 5,7 l/min. -	1.00	14