

## Data Sheet | Item Number: 2201-1205

2-conductor through terminal block; with push-button; 1.5 mm<sup>2</sup>; with test port; suitable for Ex e II applications; side and center marking; for DIN-rail 35 x 15 and 35 x 7.5; Push-in CAGE CLAMP®; 1,50 mm<sup>2</sup>; black

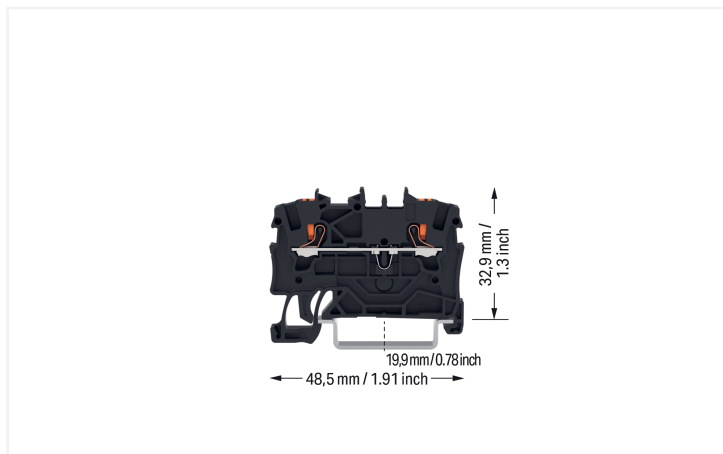

<https://www.wago.com/2201-1205>



Color: ■ black

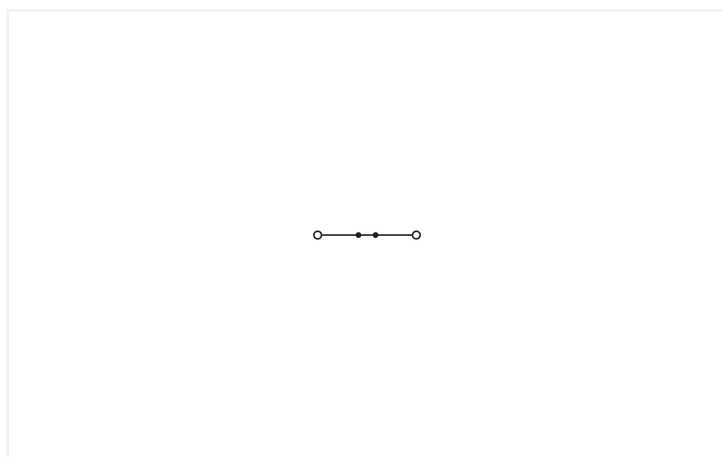

Similar to illustration

Through terminal block, 2201 Series, Push-in CAGE CLAMP®

This through terminal block (item number 2201-1205) streamlines wire connections, making them both quick and easy. Ensure that the strip lengths are between 9 and 11 mm when connecting conductors to this through terminal block. Whether for industrial or building applications, you can use our

through terminal blocks to connect electrical conductors quickly and safely. We offer variants for both classic through-wiring and potential distribution. This product incorporates conductor terminals and utilizes Push-in CAGE CLAMP®. Push-in CAGE CLAMP® technology provides a universal connection solution for any type of conductor. It allows both solid and fine-stranded conductors with ferrules to be inserted directly into the clamping point without the need for tools. Dimensions: (4.2 x 48.5 x 39.5) mm (width x height x depth). This through terminal block is suitable for conductor cross sections ranging from 0.25 mm<sup>2</sup> to 2.5 mm<sup>2</sup>.

This through rail-mount terminal block is operated with a push-button. Our TOPJOB® S rail-mount terminal blocks offer more than just secure electrical connections in different industrial applications and modern building installations. They also offer the perfect actuation option for every application: lever, push-button, or operating slot. This product is designed for specific Ex applications (please refer to the product datasheet).

### Electrical data

Ratings per	IEC/EN 60947-7-1			Approvals per	UL 1059		
Overvoltage category	III	III	II	Use group	B	C	D
Pollution degree	3	2	2	Rated voltage	600 V	600 V	-
Nominal voltage	800 V	-	-	Rated current	15 A	15 A	-
Rated impulse withstand voltage	8 kV	-	-				
Rated current	17.5 A	-	-				
Current at conductor cross-section (max.) mm <sup>2</sup>	24 A	-	-				

Approvals per	CSA 22.2 No 158		
Use group	B	C	D
Rated voltage	600 V	600 V	-
Rated current	15 A	15 A	-

Ex information	
Reference to hazardous areas	See "Downloads – Documentation – Additional Information: Technical Section; Technical Explanations"
Ratings per	ATEX: PTB 18 ATEX 1004 U / IECEx: PTB 18.0011U (Ex eb IIC Gb)
Rated voltage EN (Ex e II)	550 V
Rated current (Ex e II)	17.5 A

### Power Loss

Power loss, per pole (potential)	0.7711 W
Rated current I <sub>N</sub> for power loss specification	18 A
Resistance value for specified, current-dependent power loss	0.00238 Ω

### General information

Wiring direction	Front-entry wiring
------------------	--------------------

### Connection Data

Clamping units	2
Total number of potentials	1
Number of levels	1
Number of jumper slots	2

Connection 1	
Connection technology	Push-in CAGE CLAMP®
Actuation type	Push-button
Connectable conductor materials	Copper
Nominal cross-section	1.5 mm <sup>2</sup>
Solid conductor	0.25 ... 2.5 mm <sup>2</sup> / 22 ... 14 AWG
Solid conductor; push-in termination	0.75 ... 2.5 mm <sup>2</sup> / 18 ... 14 AWG
Fine-stranded conductor	0.25 ... 2.5 mm <sup>2</sup> / 22 ... 14 AWG
Fine-stranded conductor; with insulated ferrule	0.25 ... 1.5 mm <sup>2</sup> / 22 ... 16 AWG
Fine-stranded conductor; with ferrule; push-in termination	0.75 ... 1.5 mm <sup>2</sup> / 18 ... 16 AWG
Note (conductor cross-section)	Depending on the conductor characteristic, a conductor with a smaller cross-section can also be inserted via push-in termination.
Strip length	9 ... 11 mm / 0.35 ... 0.43 inches
Wiring direction	Front-entry wiring

### Physical data

Width	4.2 mm / 0.165 inches
Height	48.5 mm / 1.909 inches
Depth from upper-edge of DIN-rail	32.9 mm / 1.295 inches
Depth	39.5 mm / 1.555 inches

### Mechanical data

Mounting type	DIN-35 rail
Marking level	Center/side marking

### Material data

Note (material data)	<a href="#">Information on material specifications can be found here</a>
Color	black
Material group	I
Insulation material (main housing)	Polyamide (PA66)
Flammability class per UL94	V0
Fire load	0.105 MJ
Actuator color	orange
Weight	4.1 g

### Environmental requirements

Processing temperature	-35 ... +85 °C
Continuous operating temperature	-60 ... +105 °C

### Environmental Testing

Test specification: Railway applications – Rolling stock – Electronic equipment	DIN EN 50155 (VDE 0115-200):2022-06
Test procedure: Railway applications – Rolling stock equipment – Vibration and shock tests	DIN EN 61373 (VDE 0115-0106):2011-04
Spectrum/Mounting location	Service life test, Category 1, Class A/B
Functional test with noise-like oscillations	Test passed according to Section 8 of the standard
Frequency	$f_1 = 5 \text{ Hz}$ to $f_2 = 150 \text{ Hz}$
Acceleration	0.101g (highest test level used for all axes)
Test duration per axis	10 min.
Test directions	X, Y and Z axes
Monitoring of contact faults and interruptions	Passed
Voltage drop measurement before and after each axis	Passed
Simulated service life test through increased levels of noise-like oscillations	Test passed according to Section 9 of the standard
Frequency	$f_1 = 5 \text{ Hz}$ to $f_2 = 150 \text{ Hz}$
Acceleration	0.572g (highest test level used for all axes)
Test duration per axis	5 h
Test directions	X, Y and Z axes
Extended testing: Monitoring of contact faults and interruptions	Passed
Extended testing: Voltage drop measurement before and after each axis	Passed
Shock test	Test passed according to Section 10 of the standard
Shock pulse form	Half sine
Acceleration	5g (highest test level used for all axes)
Shock duration	30 ms

### Environmental Testing

Number of shocks (per axis)	3 pos. und 3 neg.
Test directions	X, Y and Z axes
Extended testing: Monitoring of contact faults and interruptions	Passed
Extended testing: Voltage drop measurement before and after each axis	Passed
Vibration and shock stress for rolling stock equipment	Passed

### Commercial data

PU (SPU)	100 pcs
Packaging type	Box
Country of origin	DE
GTIN	4066966410792
Customs tariff number	85369010000

### Product Classification

UNSPSC	39121410
ETIM 9.0	EC000897
ETIM 10.0	EC000897
ECCN	NO US CLASSIFICATION

### Environmental Product Compliance

RoHS Compliance Status	Compliant, No Exemption
------------------------	-------------------------

### Approvals / Certificates

#### General approvals



Approval	Standard	Certificate Name
CCA DEKRA Certification B.V.	EN 60947	NTR NL 7825
cURus Underwriters Laboratories Inc.	UL 1059	E45172
KEMA/KEUR DEKRA Certification B.V.	EN 60947	71-113099

#### Declarations of conformity and manufacturer's declarations



Approval	Standard	Certificate Name
ATEX-Attestation of Conformity WAGO GmbH & Co. KG	-	-
EU-Declaration of Conformity WAGO GmbH & Co. KG	-	-
Railway WAGO GmbH & Co. KG	-	Z00004403.000
UK-Declaration of Conformity WAGO GmbH & Co. KG	-	-

#### Approvals for marine applications



Approval	Standard	Certificate Name
ABS American Bureau of Shipping	-	24-0095985-PDA
BV Bureau Veritas S.A.	IEC 60947	58186/A0 BV

#### Approvals for marine applications

DNV GL Det Norske Veritas, Germanischer Lloyd	-	TAE00003JT
LR Lloyds Register	-	19/20050

Approvals for hazardous areas



Approval	Standard	Certificate Name
AEx UL International Germany GmbH c/o Physikalisch Technische Bundesanstalt	UL 60079	E185892 (AEx eb IIC resp. Ex eb IIC)
ATEX Physikalisch Technische Bundesanstalt	IEC 60079-0	PTB 18 ATEX 1004 U (II 2 G Ex eb IIC Gb bzw. I M 2 Ex eb I Mb)
CCCEX CQST/CNEx	GB/T 3836.3	2020312313000167
IECEX Physikalisch Technische Bundesanstalt	IEC 60079-0	IECEX PTB 18.0011U (Ex eb IIC Gb and Ex eb I Mb)
INMETRO TÜV Rheinland do Brasil Ltda.	IEC 60079	TÜV 19.0083 U

Downloads

Environmental Product Compliance

Compliance Search
Environmental Product Compliance 2201-1205

CAD/CAE-Data

CAD data
2D/3D Models 2201-1205

1 Compatible Products

1.1 Required Accessories

1.1.1 End plate

1.1.1.1 End plate



[Item No.: 2002-1291](#)  
End and intermediate plate; 0.8 mm thick;  
gray

[Item No.: 2002-1292](#)  
End and intermediate plate; 0.8 mm thick;  
orange

[Item No.: 209-191](#)  
Separator for Ex e/Ex i applications; 3 mm  
thick; 120 mm wide; orange

## 1.2 Optional Accessories

### 1.2.1 DIN-rail

#### 1.2.1.1 Mounting accessories



**Item No.: 210-196**

Aluminum carrier rail; 35 x 8.2 mm; 1.6 mm thick; 2 m long; unslotted; similar to EN 60715; silver-colored



**Item No.: 210-198**

Copper carrier rail; 35 x 15 mm; 2.3 mm thick; 2 m long; unslotted; according to EN 60715; copper-colored



**Item No.: 210-197**

Steel carrier rail; 35 x 15 mm; 1.5 mm thick; 2 m long; slotted; similar to EN 60715; silver-colored



**Item No.: 210-114**

Steel carrier rail; 35 x 15 mm; 1.5 mm thick; 2 m long; unslotted; similar to EN 60715; silver-colored



**Item No.: 210-118**

Steel carrier rail; 35 x 15 mm; 2.3 mm thick; 2 m long; unslotted; according to EN 60715; silver-colored



**Item No.: 210-115**

Steel carrier rail; 35 x 7.5 mm; 1 mm thick; 2 m long; slotted; according to EN 60715; "Hole width 18 mm; silver-colored



**Item No.: 210-112**

Steel carrier rail; 35 x 7.5 mm; 1 mm thick; 2 m long; slotted; according to EN 60715; "Hole width 25 mm; silver-colored



**Item No.: 210-113**

Steel carrier rail; 35 x 7.5 mm; 1 mm thick; 2 m long; unslotted; according to EN 60715; silver-colored

### 1.2.2 End plate

#### 1.2.2.1 End plate



**Item No.: 209-190**

Separator for Ex e/Ex i applications; 3 mm thick; 90 mm wide; orange



**Item No.: 2002-1293**

Separator plate; 2 mm thick; oversized; gray



**Item No.: 2002-1294**

Separator plate; 2 mm thick; oversized; orange

### 1.2.3 Ferrule

#### 1.2.3.1 Ferrule



**Item No.: 216-241**

Ferrule; Sleeve for 0.5 mm<sup>2</sup> / 20 AWG; insulated; electro-tin plated; electrolytic copper; gastight crimped; acc. to DIN 46228, Part 4/09.90; white



**Item No.: 216-242**

Ferrule; Sleeve for 0.75 mm<sup>2</sup> / 18 AWG; insulated; electro-tin plated; electrolytic copper; gastight crimped; acc. to DIN 46228, Part 4/09.90; gray



**Item No.: 216-243**

Ferrule; Sleeve for 1 mm<sup>2</sup> / AWG 18; insulated; electro-tin plated; electrolytic copper; gastight crimped; acc. to DIN 46228, Part 4/09.90; red



**Item No.: 216-244**

Ferrule; Sleeve for 1.5 mm<sup>2</sup> / AWG 16; insulated; electro-tin plated; electrolytic copper; gastight crimped; acc. to DIN 46228, Part 4/09.90; black

### 1.2.4 Installation

#### 1.2.4.1 Cover



**Item No.: 709-156**

Cover; Type 3; suitable for cover carrier, type 3; 1 m long; transparent

#### 1.2.4.2 Cover carrier



**Item No.: 709-169**

Cover carrier; Type 3; incl. fixing/retaining screws and knurled nut; suitable for 279 to 282 and 880 Series rail-mounted terminal blocks; suitable for 264 Series miniature rail-mounted terminal blocks; suitable for 270 Series sensor and actuator terminal blocks; gray

1.2.5 Insulation stop

1.2.5.1 Insulation stop



**Item No.: 2001-171**

Insulation stop; 0.25 - 0.5 mm<sup>2</sup>; 5 pieces/strip; light gray

1.2.6 Jumper

1.2.6.1 Jumper



**Item No.: 2001-406/020-000**

Delta jumper; insulated; light gray



**Item No.: 2001-410**

Jumper; 10-way; insulated; light gray



**Item No.: 2001-402**

Jumper; 2-way; insulated; light gray



**Item No.: 2001-403**

Jumper; 3-way; insulated; light gray



**Item No.: 2001-404**

Jumper; 4-way; insulated; light gray



**Item No.: 2001-405**

Jumper; 5-way; insulated; light gray



**Item No.: 2001-406**

Jumper; 6-way; insulated; light gray



**Item No.: 2001-407**

Jumper; 7-way; insulated; light gray



**Item No.: 2001-408**

Jumper; 8-way; insulated; light gray



**Item No.: 2001-409**

Jumper; 9-way; insulated; light gray



**Item No.: 2001-440**

Jumper; from 1 to 10; insulated; light gray



**Item No.: 2001-433**

Jumper; from 1 to 3; insulated; light gray



**Item No.: 2001-434**

Jumper; from 1 to 4; insulated; light gray



**Item No.: 2001-435**

Jumper; from 1 to 5; insulated; light gray



**Item No.: 2001-436**

Jumper; from 1 to 6; insulated; light gray



**Item No.: 2001-437**

Jumper; from 1 to 7; insulated; light gray



**Item No.: 2001-438**

Jumper; from 1 to 8; insulated; light gray



**Item No.: 2001-439**

Jumper; from 1 to 9; insulated; light gray



**Item No.: 2001-405/011-000**

Star point jumper; 3-way; insulated; light gray



**Item No.: 2006-499**

Step-down jumper; from 2006/2004 to 2004/2002/2001 series; from 2206/2204 to 2204/2202/2201 series; insulated; light gray



**Item No.: 210-103**

Wire commoning chain; insulated; black



**Item No.: 210-123**

Wire commoning chain; insulated; blue

1.2.7 Marking

1.2.7.1 Marker



**Item No.: 793-4501/000-006**

WMB marking card; as card; stretchable 4 - 4.2 mm; plain; snap-on type; blue



**Item No.: 793-4501/000-007**

WMB marking card; as card; stretchable 4 - 4.2 mm; plain; snap-on type; gray



**Item No.: 793-4501/000-023**

WMB marking card; as card; stretchable 4 - 4.2 mm; plain; snap-on type; green



**Item No.: 793-4501/000-017**

WMB marking card; as card; stretchable 4 - 4.2 mm; plain; snap-on type; light green



**Item No.: 793-4501/000-012**

WMB marking card; as card; stretchable 4 - 4.2 mm; plain; snap-on type; orange



**Item No.: 793-4501/000-005**

WMB marking card; as card; stretchable 4 - 4.2 mm; plain; snap-on type; red



**Item No.: 793-4501/000-024**

WMB marking card; as card; stretchable 4 - 4.2 mm; plain; snap-on type; violet



**Item No.: 793-4501**

WMB marking card; as card; stretchable 4 - 4.2 mm; plain; snap-on type; white



**Item No.: 793-4501/000-002**

WMB marking card; as card; stretchable 4 - 4.2 mm; plain; snap-on type; yellow



**Item No.: 2009-114/000-006**

WMB-Inline; for Smart Printer; 2000 pieces on roll; stretchable 4 - 4.2 mm; plain; snap-on type; blue



**Item No.: 2009-114/000-007**

WMB-Inline; for Smart Printer; 2000 pieces on roll; stretchable 4 - 4.2 mm; plain; snap-on type; gray



**Item No.: 2009-114/000-023**

WMB-Inline; for Smart Printer; 2000 pieces on roll; stretchable 4 - 4.2 mm; plain; snap-on type; green

1.2.7.1 Marker



**Item No.: 2009-114/000-012**  
WMB-Inline; for Smart Printer; 2000 pieces on roll; stretchable 4 - 4.2 mm; plain; snap-on type; orange



**Item No.: 2009-114/000-005**  
WMB-Inline; for Smart Printer; 2000 pieces on roll; stretchable 4 - 4.2 mm; plain; snap-on type; red



**Item No.: 2009-114/000-024**  
WMB-Inline; for Smart Printer; 2000 pieces on roll; stretchable 4 - 4.2 mm; plain; snap-on type; violet



**Item No.: 2009-114**  
WMB-Inline; for Smart Printer; 2000 pieces on roll; stretchable 4 - 4.2 mm; plain; snap-on type; white



**Item No.: 2009-114/000-002**  
WMB-Inline; for Smart Printer; 2000 pieces on roll; stretchable 4 - 4.2 mm; plain; snap-on type; yellow

1.2.7.2 Marking strip



**Item No.: 2009-110**  
Marking strips; for Smart Printer; on reel; not stretchable; plain; snap-on type; white

1.2.8 Push-in type wire jumper

1.2.8.1 Jumper



**Item No.: 2009-414**  
Push-in type wire jumper; 1.5 mm<sup>2</sup>; insulated; 110 mm long; black



**Item No.: 2009-414/000-005**  
Push-in type wire jumper; 1.5 mm<sup>2</sup>; insulated; 110 mm long; black



**Item No.: 2009-416**  
Push-in type wire jumper; 1.5 mm<sup>2</sup>; insulated; 250 mm long; black



**Item No.: 2009-414/000-006**  
Push-in type wire jumper; insulated; 110 mm long; black



**Item No.: 2009-412**  
Push-in type wire jumper; insulated; 60 mm long; black

1.2.9 Test and measurement

1.2.9.1 Testing accessories



**Item No.: 2001-560**  
Modular TOPJOB®S connector; modular; for jumper contact slot; 10-pole; gray



**Item No.: 2001-511**  
Modular TOPJOB®S connector; modular; for jumper contact slot; 1-pole; gray



**Item No.: 2001-552**  
Modular TOPJOB®S connector; modular; for jumper contact slot; 2-pole; gray



**Item No.: 2001-553**  
Modular TOPJOB®S connector; modular; for jumper contact slot; 3-pole; gray



**Item No.: 2001-554**  
Modular TOPJOB®S connector; modular; for jumper contact slot; 4-pole; gray



**Item No.: 2001-555**  
Modular TOPJOB®S connector; modular; for jumper contact slot; 5-pole; gray



**Item No.: 2001-556**  
Modular TOPJOB®S connector; modular; for jumper contact slot; 6-pole; gray



**Item No.: 2001-557**  
Modular TOPJOB®S connector; modular; for jumper contact slot; 7-pole; gray



**Item No.: 2001-558**  
Modular TOPJOB®S connector; modular; for jumper contact slot; 8-pole; gray



**Item No.: 2001-559**  
Modular TOPJOB®S connector; modular; for jumper contact slot; 9-pole; gray



**Item No.: 2001-549**  
Spacer module; modular; e.g., for bridging commoned terminal blocks; gray



**Item No.: 2009-174**  
Test plug adapter; for 4 mm Ø test plugs; for testing TOPJOB®S rail-mounted terminal blocks; gray



**Item No.: 210-136**  
Test plug; 2 mm Ø; with 500 mm cable; red



**Item No.: 2009-182**  
Testing tap; for max. 2.5 mm<sup>2</sup>; tool-free connection for individual test wires 0.08 - 2.5 mm; gray

## 1.2.10 Tool

### 1.2.10.1 Operating tool



**Item No.: 210-719**

Operating tool; Blade: 2.5 x 0.4 mm; with a partially insulated shaft



**Item No.: 210-648**

Operating tool; Blade: 2.5 x 0.4 mm; with a partially insulated shaft; angled; short



**Item No.: 210-647**

Operating tool; Blade: 2.5 x 0.4 mm; with a partially insulated shaft; multicoloured

## Installation Notes

### Conductor termination

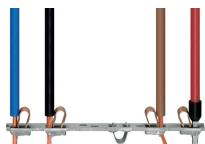

**All conductor types at a glance**



Push-in termination of solid and ferruled conductors



Insert fine-stranded conductors via operating tool.

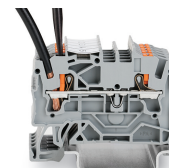

Removing all conductors via operating tool.

### Commoning

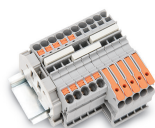

Insert a push-in type jumper bar and push down until it hits the backstop.



Commoning with step-down jumpers.

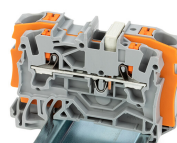

**Step-down jumper (2006-499)** commons 6/4 mm<sup>2</sup> (10/12 AWG) terminal blocks (2206/2204 Series) with 4/2.5/1.5 mm<sup>2</sup> (AWG 12/14/16) terminal blocks (2204/2202/2201 Series).

### Testing



Testing with a 2 mm Ø test plug (max. 42 V).

### Marking

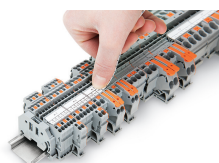

Snapping a marking strip into a marker slot.

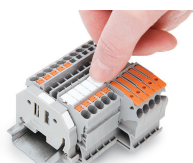

Snapping a marking strip into the marker slot.