

Data Sheet | Item Number: 2003-931

Double fuse plug; for glass cartridge fuse 1/4" x 1 1/4"; without blown fuse indication; 10.4 mm wide; gray

<https://www.wago.com/2003-931>

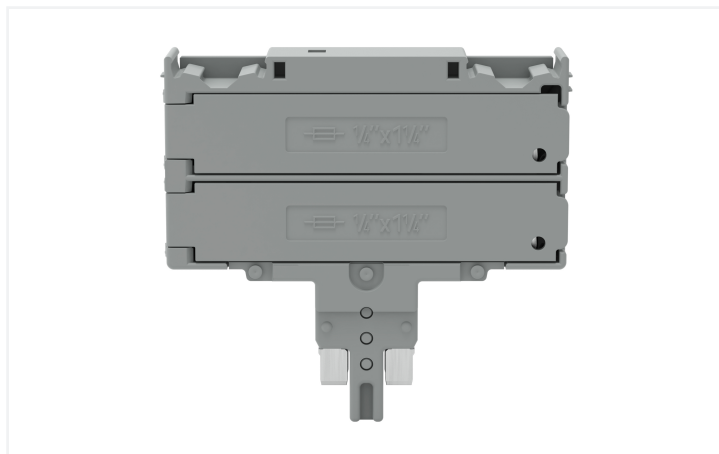

Color: ■ gray

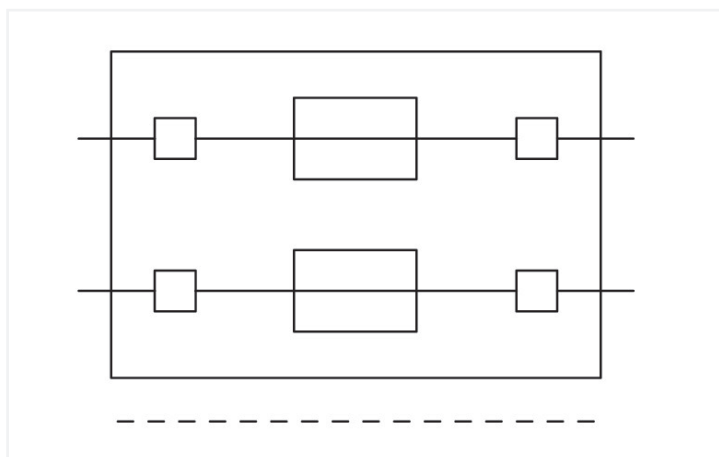
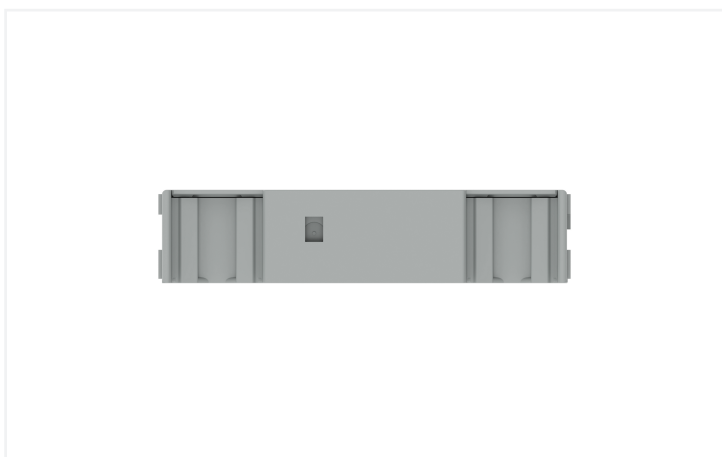
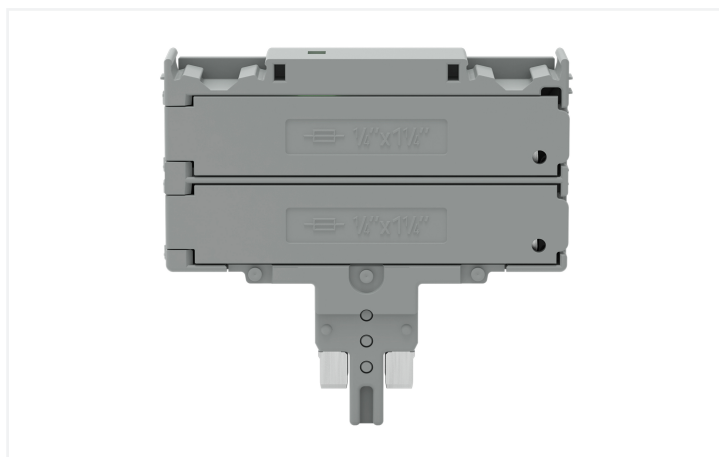

Fuse plug, 2003 Series, gray

Enjoy error-free electrical installations with this fuse plug (item number 2003-931). Dimensions: (10.4 x 45.8 x 41.9) mm (width x height x depth).

Electrical data

Ratings per IEC/EN

Nominal voltage (III/3)	250 V
Rated current	10 A
Operation status indicator	None

Ratings per IEC/EN – Notes

Ratings (note)	Electrical ratings are given by the fuse.
----------------	---

Ratings per UL

Rated voltage UL (Use Group B)	250 V
Rated current UL (Use Group B)	10 A
Rated voltage UL (Use Group C)	250 V
Rated current UL (Use Group C)	10 A

Power Loss

Power loss (max.) $P_{I(max)}$ (note)	When selecting glass cartridge fuses, make sure that the maximum power loss listed below is not exceeded. The power loss is determined according to IEC or EN 60947-7-3/VDE 0611-6 at 23°C. The temperature rise of the terminal block must be checked according to their application and mounting. Higher ambient temperatures represent an additional impact on miniature fuses. Therefore, in such applications, the rated current must be reduced if necessary. More details are available from the manufacturers.
---------------------------------------	--

General information

Fuse type	Cylindrical fuse; ¼" x 1¼"
-----------	----------------------------

Physical data

Width	10.4 mm / 0.409 inches
Height	45.8 mm / 1.803 inches
Depth	41.9 mm / 1.65 inches

Material data

Note (material data)	Information on material specifications can be found here
Color	gray
Material group	I
Insulation material (main housing)	Polyamide (PA66)
Flammability class per UL94	V0
Fire load	0.168 MJ
Weight	12.1 g

Environmental requirements

Processing temperature	-35 ... +85 °C
Continuous operating temperature	-60 ... +105 °C

Commercial data

Product Group	22 (TOPJOB S)
PU (SPU)	25 pcs
Packaging type	Box
Country of origin	DE
GTIN	4050821270393
Customs tariff number	85366990990

Product Classification	
ETIM 9.0	EC002018
ETIM 10.0	EC002018
ECCN	NO US CLASSIFICATION

Environmental Product Compliance	
RoHS Compliance Status	Compliant, No Exemption

Approvals / Certificates

General approvals



Approval	Standard	Certificate Name
UL Underwriters Laboratories Inc.	UL 1059	E45172

Downloads

Environmental Product Compliance

Compliance Search
Environmental Product Compliance 2003-931 

1 Compatible Products

1.1 Optional Accessories

1.1.1 Jumper

1.1.1.1 Jumper



[Item No.: 281-503](#)
Short circuit jumper; for fuse holder; silver-colored

1.1.2 Marking

1.1.2.1 Marker



[Item No.: 793-5501/000-006](#)
WMB marking card; as card; for terminal block width 5 - 17.5 mm; stretchable 5 - 5.2 mm; plain; snap-on type; blue



[Item No.: 793-5501/000-014](#)
WMB marking card; as card; for terminal block width 5 - 17.5 mm; stretchable 5 - 5.2 mm; plain; snap-on type; brown



[Item No.: 793-5501/000-007](#)
WMB marking card; as card; for terminal block width 5 - 17.5 mm; stretchable 5 - 5.2 mm; plain; snap-on type; gray



[Item No.: 793-5501/000-023](#)
WMB marking card; as card; for terminal block width 5 - 17.5 mm; stretchable 5 - 5.2 mm; plain; snap-on type; green



[Item No.: 793-5501/000-017](#)
WMB marking card; as card; for terminal block width 5 - 17.5 mm; stretchable 5 - 5.2 mm; plain; snap-on type; light green



[Item No.: 793-5501/000-012](#)
WMB marking card; as card; for terminal block width 5 - 17.5 mm; stretchable 5 - 5.2 mm; plain; snap-on type; orange







[Item No.: 793-5501/000-005](#)
WMB marking card; as card; for terminal block width 5 - 17.5 mm; stretchable 5 - 5.2 mm; plain; snap-on type; red



[Item No.: 793-5501/000-024](#)
WMB marking card; as card; for terminal block width 5 - 17.5 mm; stretchable 5 - 5.2 mm; plain; snap-on type; violet

1.1.2.1 Marker



 <p>Item No.: 793-5501 WMB marking card; as card; for terminal block width 5 - 17.5 mm; stretchable 5 - 5.2 mm; plain; snap-on type; white</p>	 <p>Item No.: 793-5501/000-002 WMB marking card; as card; for terminal block width 5 - 17.5 mm; stretchable 5 - 5.2 mm; plain; snap-on type; yellow</p>	 <p>Item No.: 794-5615 WMB marking card; as card; MARKED; F1, ..., F10 (10x); stretchable 5 - 5.2 mm; Vertical marking; snap-on type; white</p>	 <p>Item No.: 794-5616 WMB marking card; as card; MARKED; F11, ..., F20 (10x); stretchable 5 - 5.2 mm; Vertical marking; snap-on type; white</p>
 <p>Item No.: 794-5617 WMB marking card; as card; MARKED; F21, ..., F30 (10x); stretchable 5 - 5.2 mm; Vertical marking; snap-on type; white</p>	 <p>Item No.: 794-5618 WMB marking card; as card; MARKED; F31, ..., F40 (10x); stretchable 5 - 5.2 mm; Vertical marking; snap-on type; white</p>	 <p>Item No.: 794-5619 WMB marking card; as card; MARKED; F41, ..., F50 (10x); stretchable 5 - 5.2 mm; Vertical marking; snap-on type; white</p>	 <p>Item No.: 2009-115/000-006 WMB-Inline; for Smart Printer; 1500 pieces on roll; stretchable 5 - 5.2 mm; plain; snap-on type; blue</p>
 <p>Item No.: 2009-115/000-007 WMB-Inline; for Smart Printer; 1500 pieces on roll; stretchable 5 - 5.2 mm; plain; snap-on type; gray</p>	 <p>Item No.: 2009-115/000-023 WMB-Inline; for Smart Printer; 1500 pieces on roll; stretchable 5 - 5.2 mm; plain; snap-on type; green</p>	 <p>Item No.: 2009-115/000-017 WMB-Inline; for Smart Printer; 1500 pieces on roll; stretchable 5 - 5.2 mm; plain; snap-on type; light green</p>	 <p>Item No.: 2009-115/000-012 WMB-Inline; for Smart Printer; 1500 pieces on roll; stretchable 5 - 5.2 mm; plain; snap-on type; orange</p>
 <p>Item No.: 2009-115/000-024 WMB-Inline; for Smart Printer; 1500 pieces on roll; stretchable 5 - 5.2 mm; plain; snap-on type; violet</p>	 <p>Item No.: 2009-115 WMB-Inline; for Smart Printer; 1500 pieces on roll; stretchable 5 - 5.2 mm; plain; snap-on type; white</p>	 <p>Item No.: 2009-115/000-002 WMB-Inline; for Smart Printer; 1500 pieces on roll; stretchable 5 - 5.2 mm; plain; snap-on type; yellow</p>	

1.1.2.2 Marking strip









 <p>Item No.: 2009-110 Marking strips; for Smart Printer; on reel; not stretchable; plain; snap-on type; white</p>

1.1.3 Terminal blocks

1.1.3.1 Carrier terminal block

 <p>Item No.: 2002-2961 Double-deck terminal terminal block; L/L; for DIN-rail 35 x 15 and 35 x 7.5; 2.5 mm²; Push-in CAGE CLAMP®; 2,50 mm²; gray</p>	 <p>Item No.: 2002-2963 Double-deck terminal terminal block; L/N; for DIN-rail 35 x 15 and 35 x 7.5; 2.5 mm²; Push-in CAGE CLAMP®; 2,50 mm²; gray</p>	 <p>Item No.: 2002-2941 Double-deck, double-disconnect terminal block; L/L; for DIN-rail 35 x 15 and 35 x 7.5; 2.5 mm²; Push-in CAGE CLAMP®; 2,50 mm²; gray</p>
---	---	--

1.1.3.2 Carrier terminal block for modules and plugs

 <p>Item No.: 2002-1661 2-conductor carrier terminal block; for DIN-rail 35 x 15 and 35 x 7.5; 2.5 mm²; Push-in CAGE CLAMP®; 2,50 mm²; gray</p>	 <p>Item No.: 2002-1662 2-conductor carrier terminal block; for DIN-rail 35 x 15 and 35 x 7.5; 2.5 mm²; Push-in CAGE CLAMP®; 2,50 mm²; orange</p>	 <p>Item No.: 2002-1961 2-conductor carrier terminal block; with additional jumper position; for DIN-rail 35 x 15 and 35 x 7.5; 2.5 mm²; Push-in CAGE CLAMP®; 2,50 mm²; gray</p>	 <p>Item No.: 2202-1661 2-conductor carrier terminal block; with push-button; for DIN-rail 35 x 15 and 35 x 7.5; 2.5 mm²; Push-in CAGE CLAMP®; 2,50 mm²; gray</p>
 <p>Item No.: 2202-1961 2-conductor carrier terminal block; with push-button; with additional jumper position; for DIN-rail 35 x 15 and 35 x 7.5; 2.5 mm²; Push-in CAGE CLAMP®; 2,50 mm²; gray</p>	 <p>Item No.: 2002-1761 3-conductor carrier terminal block; for DIN-rail 35 x 15 and 35 x 7.5; 2.5 mm²; Push-in CAGE CLAMP®; 2,50 mm²; gray</p>	 <p>Item No.: 2202-1761 3-conductor carrier terminal block; with push-button; for DIN-rail 35 x 15 and 35 x 7.5; 2.5 mm²; Push-in CAGE CLAMP®; 2,50 mm²; gray</p>	 <p>Item No.: 2002-1861 4-conductor carrier terminal block; for DIN-rail 35 x 15 and 35 x 7.5; 2.5 mm²; Push-in CAGE CLAMP®; 2,50 mm²; gray</p>

1.1.3.2 Carrier terminal block for modules and plugs



Item No.: 2202-1861

4-conductor carrier terminal block; with push-button; for DIN-rail 35 x 15 and 35 x 7.5; 2.5 mm²; Push-in CAGE CLAMP®; 2,50 mm²; gray

Item No.: 2002-2941

Double-deck, double-disconnect terminal block; L/L; for DIN-rail 35 x 15 and 35 x 7.5; 2.5 mm²; Push-in CAGE CLAMP®; 2,50 mm²; gray

1.1.3.3 Double-deck terminal block



Item No.: 2002-2961

Double-deck carrier terminal block; L/L; for DIN-rail 35 x 15 and 35 x 7.5; 2.5 mm²; Push-in CAGE CLAMP®; 2,50 mm²; gray

Item No.: 2002-2963

Double-deck carrier terminal block; L/N; for DIN-rail 35 x 15 and 35 x 7.5; 2.5 mm²; Push-in CAGE CLAMP®; 2,50 mm²; gray

Item No.: 2002-2941

Double-deck, double-disconnect terminal block; L/L; for DIN-rail 35 x 15 and 35 x 7.5; 2.5 mm²; Push-in CAGE CLAMP®; 2,50 mm²; gray

1.1.3.4 Multilevel installation terminal block



Item No.: 2003-6662

Multilevel installation terminal block; with operating slots; 2.5 mm²; Carrier terminal block without knife; L/L/PE; Push-in CAGE CLAMP®; 2,50 mm²; gray

Item No.: 2003-6661

Multilevel installation terminal block; with operating slots; 2.5 mm²; Carrier terminal block without knife; L/N/PE; Push-in CAGE CLAMP®; 2,50 mm²; gray

Item No.: 2003-6640

Multilevel installation terminal block; with operating slots; 2.5 mm²; Carrier terminal block without knife; N/L/PE; Push-in CAGE CLAMP®; 2,50 mm²; gray

Item No.: 2003-6660

Multilevel installation terminal block; with operating slots; 2.5 mm²; Carrier terminal block without knife; P1/P2/PE; Push-in CAGE CLAMP®; 2,50 mm²; gray



Item No.: 2003-6643

Multilevel installation terminal block; with operating slots; 2.5 mm²; Carrier terminal block without knife; P2/P1/PE; Push-in CAGE CLAMP®; 2,50 mm²; gray

Installation Notes

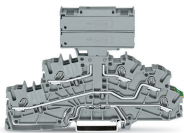

Double-fuse plugs with (¼" x 1¼") glass cartridge fuses can be used on carrier terminal blocks without an N-knife disconnect in standard terminal block width.