

27 813 660 Produktversion ab 01.09.2025

















- Brausekopf Ø 100 mm
- Dreifach bzw. fünffach verstellbar: PURIFY RAIN, COMPACT SOFT FLOW, COMPACT AQUAPRESSURE FLOW, Durchfluss max. 15 l/min (bei 3 Bar)
- Funktion ab: 6,8 l/min
- Eigensicher gegen Rückfließen
- mit Antikalk-System
- Metallbrauseschlauch 1250 mm mit integriertem Verdreherschutz

Technische Daten:

- Rosette Ø 60 mm
- Anschluss 1/2"

Hinweise:

	Chrom gebürstet	27 813 660-93
	Chrom	27 813 660-00
	Platin gebürstet	27 813 660-06
	Platin	27 813 660-08
	Dark Chrome	27 813 660-19
	Light Gold (PVD)	27 813 660-26
	Light Gold gebürstet (PVD)	27 813 660-27
	Messing gebürstet (23kt Gold)	27 813 660-28
	Schwarz matt	27 813 660-33
	Gold gebürstet (PVD)	27 813 660-37
	Dark Brass gebürstet (PVD)	27 813 660-39
	Bronze gebürstet (PVD)	27 813 660-42
	Champagne gebürstet (22kt Gold)	27 813 660-46
	Champagne (22kt Gold)	27 813 660-47
	Dark Platin gebürstet	27 813 660-99

Empfohlenes Zubehör

UP-Wandwinkel -

35 085 970 90



- Min. Einbautiefe 90 mm
- Max. Einbautiefe 163 mm

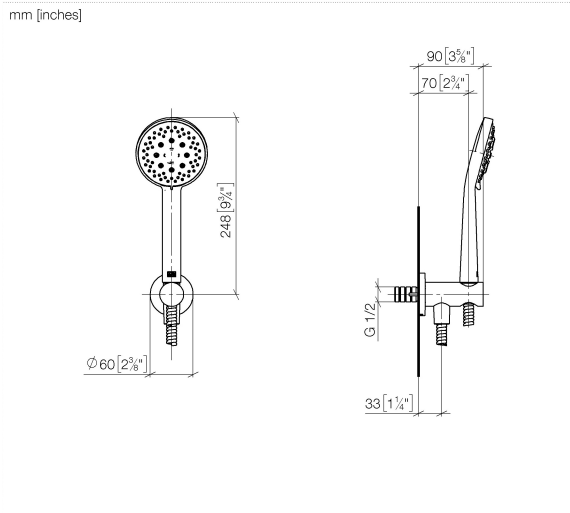

Durchflussdiagramm



Codes & Standards

EN 1717



Schlauchbrausegarnitur mit integriertem Brausehalter - Chrom gebürstet

SERIENSPEZIFISC

27 813 660 Produktversion ab 01.09.2025

Zertifikate und Nachhaltigkeit

Belgaqua_25-344-2

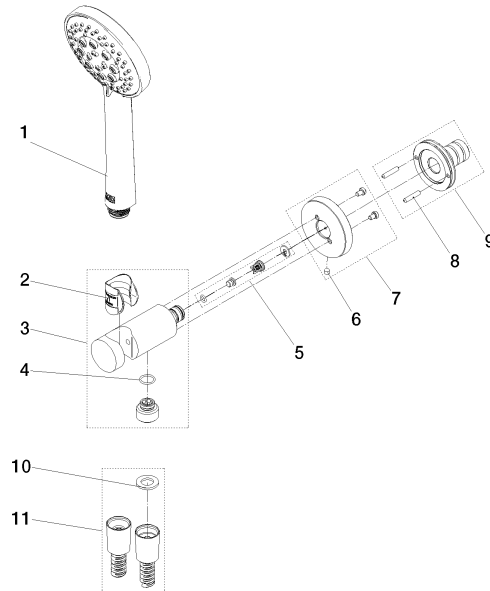

Ersatzteilstückliste

Nr.	Artikelnummer	Benennung	Verbaumenge	Lieferzeit
8	90 24 03 325 00 90	Nippel	1,00	2
3	90 11 03 137 00-93	Anschluss	1,00	20
10	90 14 20 026 00 90	Dichtung 14 x 8 x 2 mm Centellen WS 3820 -	1,00	2
11	90 30 02 008 00-93	Schlauch mit Konus 1/2" x 1/2" x 1250 mm - Chrom gebürstet	1,00	20
7	90 27 66 029 00-93	Rosette Ø 60 x 9,5 mm - Chrom gebürstet	1,00	20
2	09 18 40 216 90	Hülse 29 x 32 x 29 mm -	1,00	2
9	04 31 11 115 00 90	Beutel m. Gewindestift M4 x 20 mm -	1,00	2
5	90 23 01 131 00 90	Rückflussverhinderer -	1,00	2
1	90 12 11 173 00-93	Handbrause 15 l/min. - Chrom gebürstet	1,00	20
4	09 14 10 213 90	O-Ring EPDM 70 12,0 x 1,5 mm -	1,00	2
6	90 31 11 112 00 90	Befestigung Gewindestift M5 x 6 mm -	1,00	2