







**CL.1 Tissue holder without cover - Brushed Dark Platinum**

CL.1

83 500 705 Product version from 3/9/2015

- width 200mm
- height 35 mm
- 70mm projection



	Brushed Dark Platinum	83 500 705-99
	Chrome	83 500 705-00
	Brushed Platinum	83 500 705-06
	Dark Chrome	83 500 705-19
	Brushed Light Gold (PVD)	83 500 705-27
	Brushed Champagne (22kt Gold)	83 500 705-46
	Champagne (22kt Gold)	83 500 705-47

83 500 705 Product version from 3/9/2015

mm [inches]

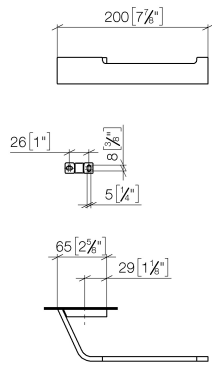

83 500 705 Product version from 3/9/2015

Parts for other finishes can be found here: [Chrome](#)

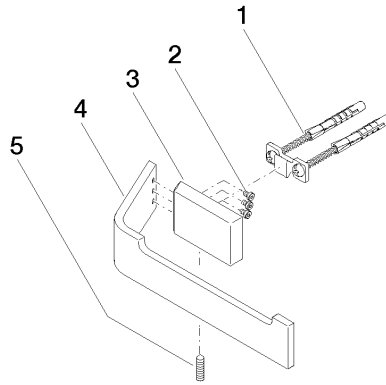

### Spare parts list

No.	Item Number	Name	Quantity used	Delivery time
4	08 17 70 553-99	Holder for toilet roll holder Rod 203 x 35 x 70 mm - Brushed Dark Platinum	1.00	40
1	05 17 20 758 00 90	Attachment set 37 x 14 x 65 mm -	1.00	14
3	08 17 70 500-99	Holder Wall bracket left 60 x 12 x 35 mm - Brushed Dark Platinum	1.00	40
5	04 31 11 113 00 90	Mounting Threaded pin M5 x 12 mm -	1.00	14
2	09 30 30 191 90	Mounting Cylinder head screw with hexagon socket M3 x 5 mm -	3.00	14