

## 40P-2622S: Press Elbow to copper compression 26x22

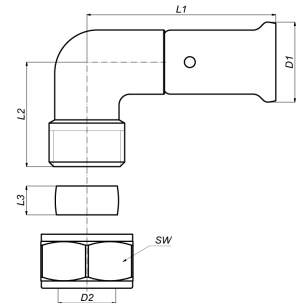

### Commercial information

The body of the fitting is made from CW617N brass. These fittings offer great advantages with regard to corrosion and they are also also better for the environment.

- The fitting has a buffer ring that prevents direct galvanic contact between the aluminium of the pipe and the brass of the fitting.
- This excludes the possibility of electrolysis occurring.
- The fitting is equipped with O-rings made from EPDM and RVS pressure sleeves with 3 inspection windows.
- In order to prevent assembly errors, the dimensions and type of press profile which can be pressed are shown on the RVS sleeves

#### Basic unit dimensions

Height	62 mm
Length	75 mm
Width	36 mm
Net weight	0.230 kg

#### Certificates

ATG, DVGW Wasser, ETA, KIWA, ÖVGW Wasser, WRAS, KOMO, STF, ÖN EN 21003-2/-3, GOST-R, ITC, TSU, QB (CSTBat), AFNOR, ACS, PZH, DNV-GL, EMI

#### Applications

Potable water, Heating, Compressed air, Cooling, Sanitary

#### Solutions

Building installations, Industry, Utility, Shipbuilding

## Technical characteristics

Material connection 1	Brass	Bend radius	26 Millimetre
Material quality connection 1	CuZn40Pb2 (CW617N)	Outer pipe diameter connection 1	26 Millimetre
Surface protection connection 1	Untreated	Outer pipe diameter connection 2	22 Millimetre
Surface treatment connection 1	Untreated	Length	75 Millimetre
Material connection 2	Brass	Length of connection 1	56 Millimetre
Material quality connection 2	CuZn40Pb2 (CW617N)	Working length connection 1	56 Millimetre
Surface protection connection 2	Untreated	Length of connection 2	42 Millimetre
Surface treatment connection 2	Untreated	Working length connection 2	42 Millimetre
Shape	Bend	Wrench width	0 Millimetre
Reducing	✘	Wrench width union nut	0 Millimetre
Eccentric	✘	Medium temperature (continuous)	-10 70 Degrees celsius
System specific	✓	Max. operating pressure at 20 °C	16 Bar
Connection 1	Press sleeve	Standard Dimension Ratio (SDR)	0
Contour code connection 1	TH		
Connection 2	Clamp connection		
Main colour fitting	Brass		
Material sealing	Ethylene-propylene diene monomer rubber (EPDM)		
With buffer stud	✓		
High tensile strength	✘		
With thermal insulation	✘		
Ring stiffness class	Other		
With sealing rings/gaskets	✓		
Capped	✘		
With drain valve	✘		
With de-aerator	✘		
FM quality mark	✘		
LPCB quality mark	✘		
ULC quality mark	✘		
UL quality mark	✘		
DIN-CERTCO certificate	✘		
VdS quality mark	✘		
With approval for TÜV	✘		
DVGW quality mark for gas	✘		
DVGW quality mark for water	✓		
KIWA certified	✓		
Gastec QA mark	✘		
KOMO certified	✓		
Type approval according to BBR/EKS	✘		