

Data Sheet | Item Number: 2200-2202

Double-deck terminal block; with push-button; Through/through terminal block; N/L; without marker carrier; Blue conductor entry lower deck; for DIN-rail 35 x 15 and 35 x 7.5; 1 mm²; Push-in CAGE CLAMP®; 1,00 mm²; gray

<https://www.wago.com/2200-2202>

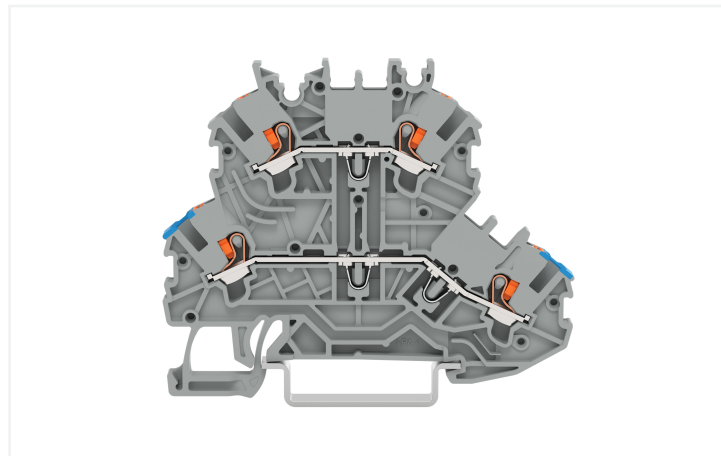
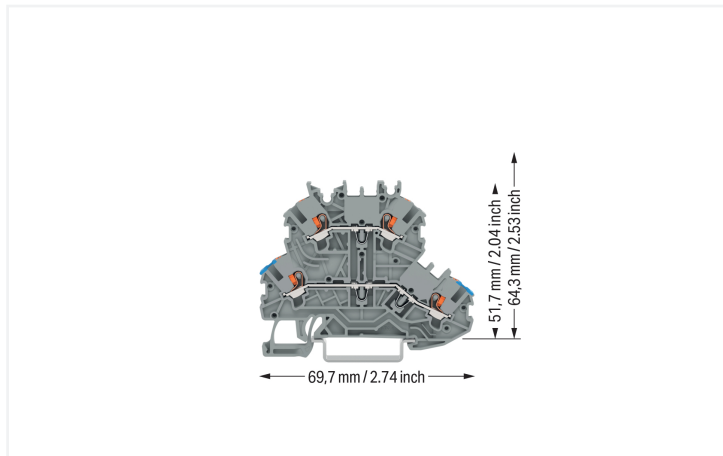

Color: ■ gray

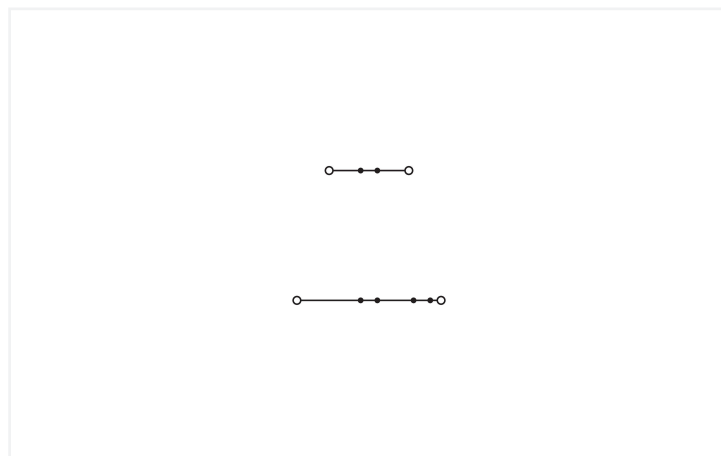
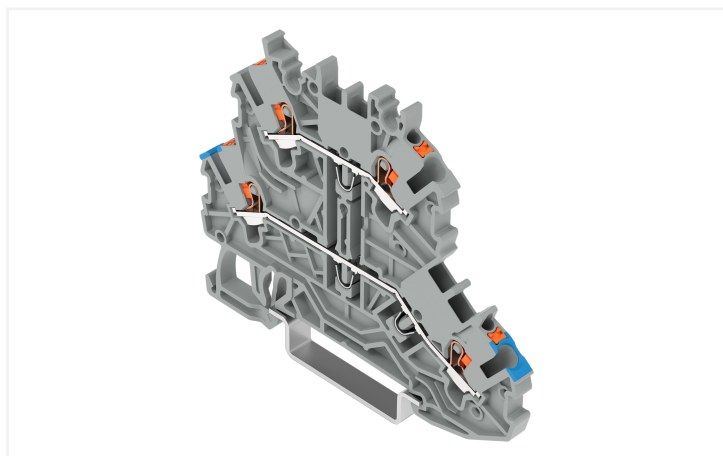

Similar to illustration

Double-deck terminal block, 2200 Series, gray

Enjoy easy electrical installations with this double-deck terminal block (item number 2200-2202). Strip lengths must be between 9 and 11 mm when connecting conductors to this double-deck terminal block. The double-deck terminal block also serves as a through terminal block. This product features conductor terminals and utilizes Push-in CAGE CLAMP®. Push-in CAGE CLAMP® technology provides a universal connection solution for any type of conductor. It allows both solid and fine-stranded conductors with ferrules to be inserted directly into the clamping point without the need for tools. Depending on the conductor type, this double-deck terminal block is suitable for conductor cross sections ranging from 0.14 mm² to 1.5 mm².

This product is designed for specific Ex applications (please refer to the product datasheet).

Electrical data

Ratings per	IEC/EN 60947-7-1		
Overvoltage category	III	III	II
Pollution degree	3	2	2
Nominal voltage	500 V	-	-
Rated impulse withstand voltage	6 kV	-	-
Rated current	13.5 A	-	-
Current at conductor cross-section (max.) mm ²	16 A	-	-

Approvals per	UL 1059		
Use group	B	C	D
Rated voltage	300 V	300 V	-
Rated current	10 A	10 A	-

Approvals per	CSA 22.2 No 158		
Use group	B	C	D
Rated voltage	300 V	300 V	-
Rated current	10 A	10 A	-

Ex information	
Reference to hazardous areas	See "Downloads – Documentation – Additional Information: Technical Section; Technical Explanations"
Ratings per	ATEX: PTB 11 ATEX 1041 U / IECEx: PTB 11.0093U (Ex eb IIC Gb)
Rated voltage EN (Ex e II)	320 V
Rated current (Ex e II)	13 A
Rated current (Ex e II) with jumper	12 A

Power Loss

Power loss, per pole (potential)	0.4338 W
Rated current I_N for power loss specification	13.5 A
Resistance value for specified, current-dependent power loss	0.00238 Ω

General information

Wiring direction	Front-entry wiring
------------------	--------------------

Connection Data

Clamping units	4
Total number of potentials	2
Number of levels	2
Number of jumper slots	4

Connection 1	
Connection technology	Push-in CAGE CLAMP®
Number of connection points	2
Actuation type	Push-button
Connectable conductor materials	Copper
Nominal cross-section	1 mm ²
Solid conductor	0.14 ... 1.5 mm ² / 24 ... 16 AWG
Solid conductor; push-in termination	0.5 ... 1.5 mm ² / 20 ... 16 AWG
Fine-stranded conductor	0.14 ... 1.5 mm ² / 24 ... 16 AWG
Fine-stranded conductor; with insulated ferrule	0.14 ... 0.75 mm ² / 24 ... 18 AWG
Fine-stranded conductor; with ferrule; push-in termination	0.5 ... 0.75 mm ² / 20 ... 18 AWG
Note (conductor cross-section)	Depending on the conductor characteristic, a conductor with a smaller cross-section can also be inserted via push-in termination.
Strip length	9 ... 11 mm / 0.35 ... 0.43 inches
Wiring direction	Front-entry wiring

Connection 2

Number of connection points	2
-----------------------------	---

Physical data

Width	3.5 mm / 0.138 inches
Height	69.7 mm / 2.744 inches
Depth from upper-edge of DIN-rail	51.7 mm / 2.035 inches

Mechanical data

Potential marking	N/L
Mounting type	DIN-35 rail
Marking level	Center/side marking

Material data

Note (material data)	Information on material specifications can be found here
Color	gray
Material group	I
Insulation material (main housing)	Polyamide (PA66)
Flammability class per UL94	V0
Fire load	0.172 MJ
Weight	7.6 g

Environmental requirements

Processing temperature	-35 ... +85 °C
Continuous operating temperature	-60 ... +105 °C

Commercial data

PU (SPU)	50 pcs
Packaging type	Box
Country of origin	IN
GTIN	4066966478785
Customs tariff number	85369010000

Product Classification

UNSPSC	39121410
ETIM 9.0	EC000897
ETIM 10.0	EC000897
ECCN	NO US CLASSIFICATION

Environmental Product Compliance

RoHS Compliance Status	Compliant, No Exemption
------------------------	-------------------------

Approvals / Certificates

General approvals



Approval	Standard	Certificate Name
CSA CSA Group	C22.2	70173737
KEMA/KEUR DEKRA Certification B.V.	EN 60947	71-134795

Declarations of conformity and manufacturer's declarations

Approval	Standard	Certificate Name
EU-Declaration of Confor- mity WAGO GmbH & Co. KG	-	-

Approvals for hazardous areas



Approval	Standard	Certificate Name
ATEX Physikalisch Technische Bundesanstalt	IEC 60079	PTB 18 ATEX 1003 U (II 2 G Ex eb II C Gb bzw. I M 2 Ex eb I Mb)
CCC CQST/CNEC	GB/T 3836.3	2020312313000166
IECEX Physikalisch Technische Bundesanstalt	IEC 60079	IECEX PTB 18.0010U (Ex eb IIC Gb and Ex eb I Mb)

Downloads

Environmental Product Compliance

Compliance Search

Environmental Product
Compliance 2200-2202



CAD/CAE-Data

CAD data

2D/3D Models
2200-2202



1 Compatible Products

1.1 Required Accessories

1.1.1 End plate

1.1.1.1 End plate



Item No.: 2000-2291

End plate; 0.7 mm thick; gray

Item No.: 2000-2292

End plate; 0.7 mm thick; orange

1.2 Optional Accessories

1.2.1 DIN-rail

1.2.1.1 Mounting accessories



Item No.: 210-196

Aluminum carrier rail; 35 x 8.2 mm; 1.6 mm thick; 2 m long; unslotted; similar to EN 60715; silver-colored



Item No.: 210-198

Copper carrier rail; 35 x 15 mm; 2.3 mm thick; 2 m long; unslotted; according to EN 60715; copper-colored



Item No.: 210-197

Steel carrier rail; 35 x 15 mm; 1.5 mm thick; 2 m long; slotted; similar to EN 60715; silver-colored



Item No.: 210-114

Steel carrier rail; 35 x 15 mm; 1.5 mm thick; 2 m long; unslotted; similar to EN 60715; silver-colored



Item No.: 210-118

Steel carrier rail; 35 x 15 mm; 2.3 mm thick; 2 m long; unslotted; according to EN 60715; silver-colored



Item No.: 210-115

Steel carrier rail; 35 x 7.5 mm; 1 mm thick; 2 m long; slotted; according to EN 60715; "Hole width 18 mm; silver-colored



Item No.: 210-112

Steel carrier rail; 35 x 7.5 mm; 1 mm thick; 2 m long; slotted; according to EN 60715; "Hole width 25 mm; silver-colored



Item No.: 210-113

Steel carrier rail; 35 x 7.5 mm; 1 mm thick; 2 m long; unslotted; according to EN 60715; silver-colored

1.2.2 Ferrule

1.2.2.1 Ferrule



Item No.: 216-241

Ferrule; Sleeve for 0.5 mm² / 20 AWG; insulated; electro-tin plated; electrolytic copper; gastight crimped; acc. to DIN 46228, Part 4/09.90; white



Item No.: 216-242

Ferrule; Sleeve for 0.75 mm² / 18 AWG; insulated; electro-tin plated; electrolytic copper; gastight crimped; acc. to DIN 46228, Part 4/09.90; gray



Item No.: 216-243

Ferrule; Sleeve for 1 mm² / AWG 18; insulated; electro-tin plated; electrolytic copper; gastight crimped; acc. to DIN 46228, Part 4/09.90; red

1.2.3 Installation

1.2.3.1 Cover



Item No.: 709-156

Cover; Type 3; suitable for cover carrier, type 3; 1 m long; transparent









































1.2.3.2 Cover carrier



Item No.: 709-169
 Cover carrier; Type 3; incl. fixing/retaining screws and knurled nut; suitable for 279 to 282 and 880 Series rail-mounted terminal blocks; suitable for 264 Series miniature rail-mounted terminal blocks; suitable for 270 Series sensor and actuator terminal blocks; gray

1.2.4 Jumper

1.2.4.1 Jumper

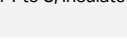
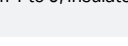
 Item No.: 2000-406/020-000 Delta jumper; insulated; light gray	 Item No.: 2000-410/000-006 Jumper; 10-way; insulated; blue	 Item No.: 2000-410 Jumper; 10-way; insulated; light gray	 Item No.: 2000-410/000-005 Jumper; 10-way; insulated; red
 Item No.: 2000-402/000-006 Jumper; 2-way; insulated; blue	 Item No.: 2000-402 Jumper; 2-way; insulated; light gray	 Item No.: 2000-402/000-005 Jumper; 2-way; insulated; red	 Item No.: 2000-402/000-018 Jumper; 2-way; insulated; yellow-green
 Item No.: 2000-403/000-006 Jumper; 3-way; insulated; blue	 Item No.: 2000-403 Jumper; 3-way; insulated; light gray	 Item No.: 2000-403/000-005 Jumper; 3-way; insulated; red	 Item No.: 2000-404/000-006 Jumper; 4-way; insulated; blue
 Item No.: 2000-404 Jumper; 4-way; insulated; light gray	 Item No.: 2000-404/000-005 Jumper; 4-way; insulated; red	 Item No.: 2000-405/000-006 Jumper; 5-way; insulated; blue	 Item No.: 2000-405 Jumper; 5-way; insulated; light gray
 Item No.: 2000-405/000-005 Jumper; 5-way; insulated; red	 Item No.: 2000-406/000-006 Jumper; 6-way; insulated; blue	 Item No.: 2000-406 Jumper; 6-way; insulated; light gray	 Item No.: 2000-406/000-005 Jumper; 6-way; insulated; red
 Item No.: 2000-407/000-006 Jumper; 7-way; insulated; blue	 Item No.: 2000-407 Jumper; 7-way; insulated; light gray	 Item No.: 2000-407/000-005 Jumper; 7-way; insulated; red	 Item No.: 2000-408/000-006 Jumper; 8-way; insulated; blue
 Item No.: 2000-408 Jumper; 8-way; insulated; light gray	 Item No.: 2000-408/000-005 Jumper; 8-way; insulated; red	 Item No.: 2000-409/000-006 Jumper; 9-way; insulated; blue	 Item No.: 2000-409 Jumper; 9-way; insulated; light gray
 Item No.: 2000-409/000-005 Jumper; 9-way; insulated; red	 Item No.: 2000-440 Jumper; from 1 to 10; insulated; light gray	 Item No.: 2000-433/000-006 Jumper; from 1 to 3; insulated; blue	 Item No.: 2000-433 Jumper; from 1 to 3; insulated; light gray
 Item No.: 2000-433/000-005 Jumper; from 1 to 3; insulated; red	 Item No.: 2000-434 Jumper; from 1 to 4; insulated; light gray	 Item No.: 2000-435 Jumper; from 1 to 5; insulated; light gray	 Item No.: 2000-436 Jumper; from 1 to 6; insulated; light gray
 Item No.: 2000-437 Jumper; from 1 to 7; insulated; light gray	 Item No.: 2000-438 Jumper; from 1 to 8; insulated; light gray	 Item No.: 2000-439 Jumper; from 1 to 9; insulated; light gray	 Item No.: 2000-405/011-000 Star point jumper; 3-way; insulated; light gray
 Item No.: 2000-492 Vertical jumper; insulated; light gray	 Item No.: 210-103 Wire commoning chain; insulated; black	 Item No.: 210-123 Wire commoning chain; insulated; blue	

1.2.5 Marking

1.2.5.1 Marker



Item No.: 793-3501

WMB marking card; as card; plain; snap-on type; white



Item No.: 2009-113/000-006

WMB-Inline; for Smart Printer; 2300 pieces on roll; plain; snap-on type; blue



Item No.: 2009-113/000-007

WMB-Inline; for Smart Printer; 2300 pieces on roll; plain; snap-on type; gray



Item No.: 2009-113/000-023

WMB-Inline; for Smart Printer; 2300 pieces on roll; plain; snap-on type; green



Item No.: 2009-113/000-017

WMB-Inline; for Smart Printer; 2300 pieces on roll; plain; snap-on type; light green



Item No.: 2009-113/000-012

WMB-Inline; for Smart Printer; 2300 pieces on roll; plain; snap-on type; orange



Item No.: 2009-113/000-005

WMB-Inline; for Smart Printer; 2300 pieces on roll; plain; snap-on type; red



Item No.: 2009-113/000-024

WMB-Inline; for Smart Printer; 2300 pieces on roll; plain; snap-on type; violet



Item No.: 2009-113

WMB-Inline; for Smart Printer; 2300 pieces on roll; plain; snap-on type; white



Item No.: 2009-113/000-002

WMB-Inline; for Smart Printer; 2300 pieces on roll; plain; snap-on type; yellow

1.2.5.2 Marker carrier



Item No.: 2000-121

Adaptor; gray

1.2.5.3 Marking strip



Item No.: 2009-110

Marking strips; for Smart Printer; on reel; not stretchable; plain; snap-on type; white

1.2.6 Protective warning marker

1.2.6.1 Cover



Item No.: 2000-115

Protective warning marker; for 5 terminal blocks; with high-voltage symbol, black; yellow

1.2.7 Push-in type wire jumper

1.2.7.1 Jumper



Item No.: 2009-404

Push-in type wire jumper; 0.75 mm²; insulated; 110 mm long; gray



Item No.: 2009-406

Push-in type wire jumper; 0.75 mm²; insulated; 250 mm long; gray



Item No.: 2009-402

Push-in type wire jumper; 0.75 mm²; insulated; 60 mm long; gray

1.2.8 Screwless end stop

1.2.8.1 Mounting accessories



Item No.: 249-117

Screwless end stop; 10 mm wide; for DIN-rail 35 x 15 and 35 x 7.5; gray



Item No.: 249-116

Screwless end stop; 6 mm wide; for DIN-rail 35 x 15 and 35 x 7.5; gray

1.2.9 Test and measurement

1.2.9.1 Testing accessories



Item No.: 2009-174

Test plug adapter; for 4 mm Ø test plugs; for testing TOPJOB®S rail-mounted terminal blocks; gray



Item No.: 2009-182

Testing tap; for max. 2.5 mm²; tool-free connection for individual test wires 0.08 - 2.5 mm; gray

1.2.10 Tool

1.2.10.1 Operating tool



Item No.: 210-719

Operating tool; Blade: 2.5 x 0.4 mm; with a partially insulated shaft



Item No.: 210-648

Operating tool; Blade: 2.5 x 0.4 mm; with a partially insulated shaft; angled; short



Item No.: 210-647

Operating tool; Blade: 2.5 x 0.4 mm; with a partially insulated shaft; multicoloured

Installation Notes

Conductor termination

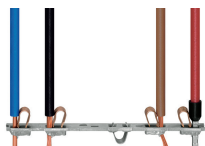

All conductor types at a glance



Push-in termination of solid and ferruled conductors



Insert fine-stranded conductors via operating tool.

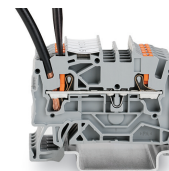

Removing all conductors via operating tool.

Commoning

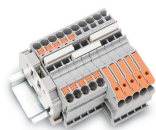

Insert a push-in type jumper bar and push down until it hits the backstop.



Commoning with step-down jumpers.

Testing



Testing with a 2 mm Ø test plug (max. 42 V).